

4

3

2

1

THIS DRAWING IS UNPUBLISHED. RELEASED FOR PUBLICATION
 © COPYRIGHT BY TYCO ELECTRONICS CORPORATION. ALL RIGHTS RESERVED.

LOC	DIST	REVISIONS					
FB	00	P	LTR	DESCRIPTION	DATE	DWN	APVD
		0		RELEASED FB00-0013-03	23JAN03	J.J	T.S

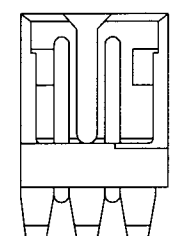
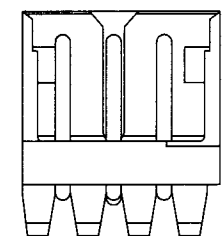
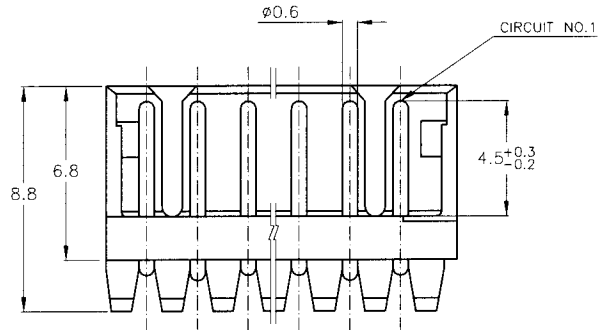
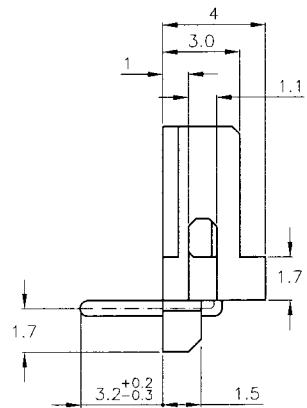
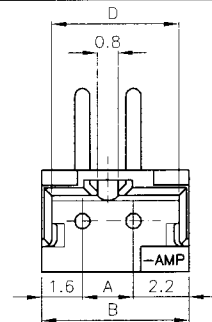
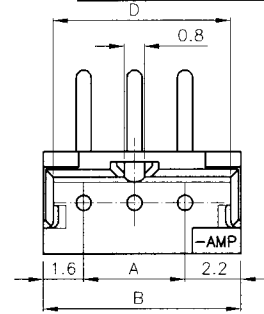
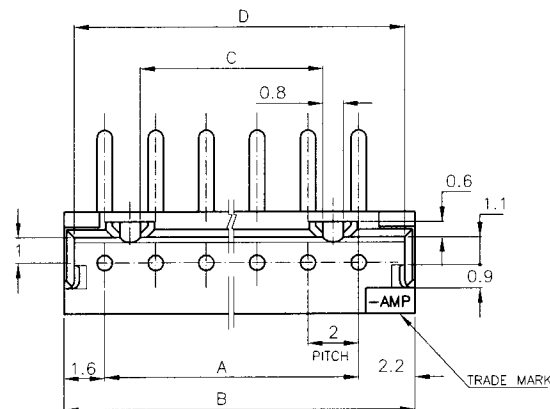

3 Pos.

2 Pos.

4~15 Pos.

NOTES:

- 1.MATERIAL: HOUSING - NYLON 66 (UL94V-0)
POST - TIN BRASS
- 2.THIS PRODUCT IS "NO-KINK" VERSION OF P/N 292253
- 3.MATING RECEPTACLE P/N 173977

					15	28	31.8	25.2	31.0
					14	26	29.8	23.2	29.0
					13	24	27.8	21.2	27.0
9-292143-2	7-292143-2	5-292143-2	3-292143-2	1-292143-2	12	22	25.8	19.2	25.0
9- ↑ -1	7- ↑ -1	5- ↑ -1	3- ↑ -1	1- ↑ -1	11	20	23.8	17.2	23.0
9- ↑ -0	7- ↑ -0	5- ↑ -0	3- ↑ -0	1- ↑ -0	10	18	21.8	15.2	21.0
8- ↑ -9	6- ↑ -9	4- ↑ -9	2- ↑ -9		9	16	19.8	13.2	19.0
8- ↑ -8	6- ↑ -8	4- ↑ -8	2- ↑ -8		8	14	17.8	11.2	17.0
8- ↑ -7	6- ↑ -7	4- ↑ -7	2- ↑ -7		7	12	15.8	9.2	15.0
8- ↑ -6	6- ↑ -6	4- ↑ -6	2- ↑ -6		6	10	13.8	7.2	13.0
8- ↑ -5	6- ↑ -5	4- ↑ -5	2- ↑ -5		5	8	11.8	5.2	11.0
8- ↑ -4	6- ↑ -4	4- ↑ -4	2- ↑ -4		4	6	9.8	3.2	9.0
8- ↑ -3	6- ↑ -3	4- ↑ -3	2- ↑ -3		3	4	7.8	—	7.0
8-292143-2	6-292143-2	4-292143-2	2-292143-2	292143-2	2	2	5.8	—	5.0
RED	BLACK	YELLOW	BLUE	NATURAL	Pos.	A	B	C	D

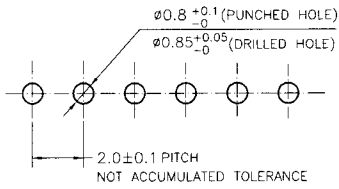

RECOMMENDABLE PCB LAYOUT
 (PCB THK:0.8-1.6)

TOLERANCES UNLESS OTHERWISE SPECIFIED:

10 > *	±0.2
30 > * > 10	±0.25
100 > * > 30	±0.3
ANGLE	±3°

THIS DRAWING IS A CONTROLLED DOCUMENT.

DIMENSIONS: MM

TOLERANCES UNLESS OTHERWISE SPECIFIED:

0 PLC	±
1 PLC	±
2 PLC	±
3 PLC	±
4 PLC	±
ANGLES	±
FINISH	±

MATERIAL: SEE NOTE

SEE NOTE

THIS DRAWING IS A CONTROLLED DOCUMENT.

DWN: S.XU 31JAN03

CHK: S.YAO 31JAN03

APVD: T. SASAKI 31JAN03

PRODUCT SPEC: 108-60016

APPLICATION SPEC: -

WEIGHT: -

CUSTOMER DRAWING

tyco Electronics
 Tyco Electronics Corporation
 SHANGHAI, CHINA

NAME: POST HEADER ASS'Y HORIZONTAL TYPE (AMP CT CONNECTOR 2mm PITCH)

SIZE: A3 CAGE CODE: 00779 DRAWING NO: C=292143 RESTRICTED TO: -

SCALE: 5:1 SHEET: 1 OF 1 REV: 0