

Front plate - VS-SI-FP-DSUB9-DSUB25 - 1656589

Please be informed that the data shown in this PDF Document is generated from our Online Catalog. Please find the complete data in the user's documentation. Our General Terms of Use for Downloads are valid (<http://download.phoenixcontact.com>)



Data front plate, plastic, for 1 x 9-pos. D-SUB and 1 x 25-pos. D-SUB, item 1656961 may be required for mounting D-SUB inserts



Key commercial data

Packing unit	1 pc
Weight per Piece (excluding packing)	20.4 GRM
Custom tariff number	85389099
Country of origin	Germany

Technical data

Ambient conditions

Ambient temperature (operation)	-10 °C ... 60 °C
---------------------------------	------------------

General

Color	gray
Housing material	PBT
Inflammability class according to UL 94	V0

Classifications

eCl@ss

eCl@ss 4.0	27140816
eCl@ss 4.1	27140816
eCl@ss 5.0	27189239
eCl@ss 5.1	27189239
eCl@ss 6.0	27144001
eCl@ss 7.0	27144001

Front plate - VS-SI-FP-DSUB9-DSUB25 - 1656589

Classifications

eCl@ss

eCl@ss 8.0	27144001
------------	----------

ETIM

ETIM 2.0	EC000007
ETIM 3.0	EC000007
ETIM 4.0	EC000007
ETIM 5.0	EC000456

UNSPSC

UNSPSC 6.01	31261501
UNSPSC 7.0901	31261501
UNSPSC 11	31261501
UNSPSC 12.01	31261501
UNSPSC 13.2	31261501

Accessories

Accessories

Marking material

Marker labels - VS-SI-BZ - 1656660



Marker label, plastic, plate with 20 labels

Mounting set - VS-SI-SCREW-GC - 1656961



Mounting set, for DSUB gender changer contact inserts

Drawings

Front plate - VS-SI-FP-DSUB9-DSUB25 - 1656589

Dimensioned drawing

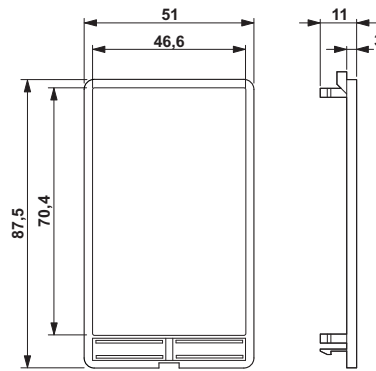

Front plate