

PCM-9389

**3.5" SBC with Intel® Atom™
N455/D525, DDR3 SODIMM or
on-board SDRAM, PC/104, 18/24-
bit LVDS, VGA, 2 GbEs, 4 COMs,
4 USBs, LPC, iManager 2.0**

ADVANTECH

Enabling an Intelligent Planet

Copyright

The documentation and the software included with this product are copyrighted 2012 by Advantech Co., Ltd. All rights are reserved. Advantech Co., Ltd. reserves the right to make improvements in the products described in this manual at any time without notice.

No part of this manual may be reproduced, copied, translated or transmitted in any form or by any means without the prior written permission of Advantech Co., Ltd. Information provided in this manual is intended to be accurate and reliable. However, Advantech Co., Ltd. assumes no responsibility for its use, nor for any infringements of the rights of third parties, which may result from its use.

Acknowledgements

AMI is a trademark of AMI Software International, Inc.

Intel® is a trademark of Intel® Technologies, Inc.

IBM, PC/AT, PS/2 and VGA are trademarks of International Business Machines Corporation.

Intel and Atom® are trademarks of Intel Corporation.

Microsoft Windows® is a registered trademark of Microsoft Corp.

RTL is a trademark of Realtek Semi-Conductor Co., Ltd.

ESS is a trademark of ESS Technology, Inc.

UMC is a trademark of United Microelectronics Corporation.

SMI is a trademark of Silicon Motion, Inc.

Creative is a trademark of Creative Technology LTD.

All other product names or trademarks are properties of their respective owners.

Product Warranty (2 years)

Advantech warrants to you, the original purchaser, that each of its products will be free from defects in materials and workmanship for two years from the date of purchase.

This warranty does not apply to any products which have been repaired or altered by persons other than repair personnel authorized by Advantech, or which have been subject to misuse, abuse, accident or improper installation. Advantech assumes no liability under the terms of this warranty as a consequence of such events.

Because of Advantech's high quality-control standards and rigorous testing, most of our customers never need to use our repair service. If an Advantech product is defective, it will be repaired or replaced at no charge during the warranty period. For out-of-warranty repairs, you will be billed according to the cost of replacement materials, service time and freight. Please consult your dealer for more details.

If you think you have a defective product, follow these steps:

1. Collect all the information about the problem encountered. (For example, CPU speed, Advantech products used, other hardware and software used, etc.) Note anything abnormal and list any onscreen messages you get when the problem occurs.
2. Call your dealer and describe the problem. Please have your manual, product, and any helpful information readily available.
3. If your product is diagnosed as defective, obtain an RMA (return merchandise authorization) number from your dealer. This allows us to process your return more quickly.
4. Carefully pack the defective product, a fully-completed Repair and Replacement Order Card and a photocopy proof of purchase date (such as your sales receipt) in a shippable container. A product returned without proof of the purchase date is not eligible for warranty service.
5. Write the RMA number visibly on the outside of the package and ship it prepaid to your dealer.

Technical Support and Assistance

1. Visit the Advantech web site at www.advantech.com/support where you can find the latest information about the product.
2. Contact your distributor, sales representative, or Advantech's customer service center for technical support if you need additional assistance. Please have the following information ready before you call:
 - Product name and serial number
 - Description of your peripheral attachments
 - Description of your software (operating system, version, application software, etc.)
 - A complete description of the problem
 - The exact wording of any error messages

Packing List

Before installation, please ensure the following items have been shipped:

Item Part Number

- 1 PCM-9389 SBC
- 1 Startup manual
- 1 Utility CD
- 1 Pack of mini jumper
- Cables

| Part Number | Description |
|-------------|--|
| 1700016141 | AT Power: 2*6P-4.2/ 2*10P-4.2, 10 cm |
| 1700017863 | LAN: RJ-45/ 2*5P-2.0, 15 cm |
| 1700018730 | USB 2pcs: 2*5P-2.0/ USB-A*2, 25 cm |
| 1700019584 | Audio: 2*5P-2.0/ audio jack*3, 20 cm |
| 1700060202 | PS/2: M-DIN 6P/ M-DIN 6P*2, 20 cm |
| 1700006291 | SATA: 7P/ 7P w/ right angle, 30 cm |
| 1700019414 | COM2 RS-232: D-SUB/ 2*5P-2.0, 30 cm |
| 1700019435 | COM2 RS-422/485: 5P-1.25/ D-SUB, 25 cm |
| 1701200220 | COM3/4: 2*10P-2.0/ D-SUB*2, 22 cm |

- Thermal solution:

| Part Number | Description |
|----------------|-------------------------------|
| 1960055364T001 | Heatsink: 73.5 x 87.5 x 15 mm |
| 1960055365T001 | Cooler: 73.5 x 87.5 x 18 mm |

Ordering information

| Model P/N | CPU | L2 Cache | Memory | TTL | Thermal | Operating Temp. |
|-------------------|------|----------|---------------|-----|---------|-----------------|
| PCM-9389N-S6A1E | N455 | 512 KB | SODIMM | - | Passive | 0 ~ 60° C |
| PCM-9389N-1GS6A1E | N455 | 512 KB | 1 GB on-board | - | Passive | 0 ~ 60° C |
| PCM-9389D-S8A1E | D525 | 1 MB | SODIMM | - | Active | 0 ~ 60° C |

Optional accessories

| Part No. | Description |
|------------------|---|
| 1960056151N001 | Heat spreader, 113 x 69.5 x 15 mm |
| PCA-COM232-00A1E | 4 RS-232 ports extension module, 31.5 x 48 mm |
| PCA-COM485-00A1E | 4 RS-422/485 ports extension module, 31.5 x 48 mm (with OEM BIOS) |
| PCA-TPM-00A1E | TPM module, 31.5x48mm |
| 1700001112 | ATX power cable, 2*10P-4.2/ 2*6P-4.2+3P-2.0, 15 cm |
| 1700018436 | SATA power cable, SATA 15P/ 5P-2.0, 10 cm |

Certification and Safety Instructions

This device complies with the requirements in part 15 of the FCC rules: Operation is subject to the following two conditions:

1. This device may not cause harmful interference, and
2. This device must accept any interference received, including interference that may cause undesired operation

This equipment has been tested and found to comply with the limits for a Class A digital device, pursuant to Part 15 of the FCC Rules. These limits are designed to provide reasonable protection against harmful interference when the equipment is operated in a commercial environment. This equipment generates, uses, and can radiate radio frequency energy and, if not installed and used in accordance with the instruction manual, may cause harmful interference to radio communications. Operation of this device in a residential area is likely to cause harmful interference in which case the user will be required to correct the interference at his/her own expense. The user is advised that any equipment changes or modifications not expressly approved by the party responsible for compliance would void the compliance to FCC regulations and therefore, the user's authority to operate the equipment.

Caution! *There is a danger of a new battery exploding if it is incorrectly installed. Do not attempt to recharge, force open, or heat the battery. Replace the battery only with the same or equivalent type recommended by the manufacturer. Discard used batteries according to the manufacturer's instructions.*



Contents

| | | |
|------------------|--|-----------|
| Chapter 1 | General Introduction | 1 |
| 1.1 | Introduction | 2 |
| 1.2 | Specifications | 2 |
| 1.2.1 | Functional Specifications | 2 |
| 1.2.2 | Mechanical Specifications | 4 |
| 1.2.3 | Electrical Specifications | 4 |
| 1.3 | Environmental Specifications | 4 |
| 1.4 | Block Diagram | 5 |
| | Figure 1.1 Block Diagram | 5 |
| | | |
| Chapter 2 | H/W Installation..... | 7 |
| 2.1 | Jumpers | 8 |
| 2.1.1 | Jumper Description | 8 |
| 2.1.2 | Jumper List | 8 |
| | Table 2.1: Jumper List | 8 |
| 2.1.3 | Jumper Settings | 9 |
| 2.2 | Connectors | 10 |
| 2.2.1 | Connector list | 10 |
| | Table 2.2: Connector List | 10 |
| 2.2.2 | Connector Settings | 10 |
| 2.3 | Mechanical | 14 |
| 2.3.1 | Jumper and Connector Locations | 14 |
| | Figure 2.1 Jumper and Connector Layout (Top Side) | 14 |
| | Figure 2.2 Jumper and Connector Layout (Bottom Side) | 14 |
| | Figure 2.3 Coastline Layout | 15 |
| 2.3.2 | Board Dimensions | 15 |
| | Figure 2.4 Board Dimension Layout (Top Side) | 15 |
| | Figure 2.5 Board Dimension Layout (Bottom Side) | 16 |
| | Figure 2.6 Board Dimension Layout (Coastline) | 16 |
| | Figure 2.7 Board Dimension Layout (Coastline Including of LPC Module) | 16 |
| | | |
| Chapter 3 | BIOS Settings..... | 19 |
| | Figure 3.1 Setup Program Initial Screen | 20 |
| 3.1 | Entering Setup | 21 |
| 3.2 | Main Setup | 21 |
| | Figure 3.2 Main Setup Screen | 21 |
| 3.2.1 | System Time / System Date | 21 |
| 3.3 | Advanced BIOS Features Setup | 22 |
| | Figure 3.3 Advanced BIOS Features Setup Screen | 22 |
| 3.3.1 | CPU Configuration | 23 |
| | Figure 3.4 CPU Configuration Setting | 23 |
| 3.3.2 | IDE Configuration | 24 |
| | Figure 3.5 IDE Configuration | 24 |
| 3.3.3 | Super I/O Configuration | 25 |
| | Figure 3.6 Super I/O Configuration | 25 |
| 3.3.4 | Hardware Monitor Configuration | 26 |
| | Figure 3.7 Hardware Health Configuration | 26 |
| 3.3.5 | ACPI Settings | 27 |
| | Figure 3.8 ACPI Settings | 27 |
| | Figure 3.9 General ACPI Configuration | 27 |

| | | |
|--------|--|----|
| | Figure 3.10Advanced ACPI Configuration..... | 28 |
| | Figure 3.11Chipset ACPI Configuration | 29 |
| 3.3.6 | AHCI Configuration..... | 30 |
| | Figure 3.12Advanced ACPI Configuration..... | 30 |
| 3.3.7 | APM Configuration..... | 31 |
| | Figure 3.13APM Configuration | 31 |
| 3.3.8 | Event Log Configuration | 32 |
| | Figure 3.14South Bridge ACPI Configuration..... | 32 |
| 3.3.9 | MPS Configuration..... | 33 |
| | Figure 3.15South Bridge ACPI Configuration..... | 33 |
| 3.3.10 | Smbios Configuration | 34 |
| | Figure 3.16South Bridge ACPI Configuration..... | 34 |
| 3.3.11 | USB Configuration | 35 |
| | Figure 3.17South Bridge ACPI Configuration..... | 35 |
| | Figure 3.18USB Mass storage Device Configuration | 36 |
| 3.4 | Advanced PCI/PnP Settings | 37 |
| | Figure 3.19PCI/PNP Setup (Top)..... | 37 |
| 3.5 | Boot Settings..... | 38 |
| | Figure 3.20Boot Setup Utility..... | 38 |
| 3.5.1 | Boot settings Configuration..... | 39 |
| | Figure 3.21Boot Setting Configuration | 39 |
| 3.6 | Security Setup..... | 40 |
| | Figure 3.22Password Configuration | 40 |
| 3.7 | Advanced Chipset Settings..... | 41 |
| | Figure 3.23Advanced Chipset Settings | 41 |
| 3.7.1 | North Bridge Chipset Configuration | 42 |
| | Figure 3.24North Bridge Configuration..... | 42 |
| | Figure 3.25Video Function Configuration | 43 |
| 3.7.2 | South Bridge Chipset Configuration | 44 |
| | Figure 3.26South Bridge Configuration | 44 |
| 3.8 | Exit Option | 45 |
| | Figure 3.27Exit Option..... | 45 |
| 3.8.1 | Save Changes and Exit | 45 |
| 3.8.2 | Discard Changes and Exit | 45 |
| 3.8.3 | Load Optimal Defaults | 45 |
| 3.8.4 | Load Fail-Safe Defaults | 46 |

Chapter 4 S/W Introduction & Installation..... 47

| | | |
|-----|-------------------------------------|----|
| 4.1 | S/W Introduction | 48 |
| 4.2 | Driver Installation | 48 |
| | 4.2.1 Windows® XP Professional..... | 48 |
| | 4.2.2 Other OS..... | 48 |
| 4.3 | Value-Added Software Services | 48 |
| | 4.3.1 SUSI Introduction..... | 48 |
| | 4.3.2 Software APIs | 49 |
| | 4.3.3 SUSI Utilities..... | 50 |
| | 4.3.4 SUSI Installation | 51 |
| | 4.3.5 SUSI Sample Programs..... | 53 |

Appendix A Pin Assignments..... 61

| | | |
|-----|---------------------------------|----|
| A.1 | Jumper Setting..... | 62 |
| | Table A.1: Jumper List..... | 62 |
| A.2 | Connectors..... | 62 |
| | Table A.2: Connector List | 62 |

Appendix B **System Assignments81**

| | | |
|-----|---|----|
| B.1 | System I/O Ports | 82 |
| | Table B.1: System I/O Ports | 82 |
| B.2 | 1st MB Memory Map | 82 |
| | Table B.2: 1st MB Memory Map | 82 |
| B.3 | DMA Channel Assignments | 83 |
| | Table B.3: DMA Channel Assignments..... | 83 |
| B.4 | Interrupt Assignments | 83 |
| | Table B.4: Interrupt Assignments..... | 83 |

Chapter 1

General Introduction

This chapter gives background information on the PCM-9389.

Sections include:

- Introduction
- Product Features
- Specifications

1.1 Introduction

PCM-9389 is a 3.5" SBC (Single Board Computer) with Embedded Intel Atom N455 1.66 GHz / D525 1.8 GHz processor. The PCM-9389 can support DDR3 SODIMM up to 4GB or 1 GB SDRAM on-board, PC/104 and LPC (Low Pin Count) expansion, VGA, 18/24-bit LVDS, 2 GbE, CF, 2 SATA, 3 RS-232 COM ports, 1 RS-232/422/485 COM port, 4 USB 2.0, SMBus or I²C, 8-bit GPIO.

1.2 Specifications

1.2.1 Functional Specifications

Processor: Intel Atom Series

- Single core N455 1.66 GHz / Dual core D525 1.8 GHz
- Intel Hyper-Threading Technology 2-thread per core
- on die 512 KB, 8-way L2 cache for N455, and on die 2 x 512 KB, 8-way L2 cache for D525
- Thermal management support via Intel Thermal Monitor (TM1)
- Supports C-state: C0-C4 for N455, C0 and C1 for D525
- Enhanced Intel SpeedStep Technology (EIST) for N455 only
- One die, primary 32 KB instructions cache and 24 KB write-back data cache
- Support IA 32-bit and Intel 64 architecture

Chipset: Intel ICH8M I/O Controller

- Supports PCI Rev2.3 at 33 MHz and 64-bit addressing using DAC protocol
- Integrated Serial ATA Host and AHCI Controller
- Integrated PATA Controller supports Ultra ATA, BMIDE and PIO modes
- USB 2.0: UHCI Host and EHCI Host Controllers
- Integrated Gigabit Ethernet Controller
- Direct Media Interface: 10Gb/s each direction, full duplex

System Memory Support

- SODIMM: N455 up to 2 GB DDRIII 667 MHz, D525 up to 4 GB DDRIII 800 MHz
- SDRAM on-board: N455 with 1 GB DDRIII 667 MHz (D525 supported by T-P/N)
- Memory data transfer rates of 667(N455) and 800(D525) MT/s

Integrated Graphics Controller

- Contains a refresh of the 3rd generation graphics core
- DirectX*9 compliant Pixel Shader* V2.0
- 200 MHz (N455) and 400 MHz (D525) render clock frequency
- 224 MB Video RAM shared with system memory
- Support Extend and Clone mode under Dual Display
- Three display ports: VGA and LVDS, TTL supported by request
 - VGA: analog RGB display output up to resolution SXGA 1400 x 1050 @ 60 Hz for N455, and up to 2048 x 1536 @ 60 Hz for D525
 - LVDS: single channel 18/24-bit LVDS resolution up to WXGA 1366 x 768
 - TTL: 18-bit TTL panel (supported by T-P/N)
 - Dual display supported: VGA + LVDS (if T-P/N with TTL, VGA+TTL is supported)
- Intel® Clear Video Technology: MPEG2 Hardware Acceleration

Gigabit Ethernet

- LAN1: ICH8M (MAC) + Intel 82567V GbE (PHY)
- LAN2: Intel 82583V GbE
- 10/100/1000 Mb/s Ethernet, supporting wake on LAN
- LAN Connect Interface (LCI) and new Gigabit LAN Connect Interface (GLCI)
- Supports IEEE 802.3, IEEE 802.3u, IEEE 802.ab

Peripheral Interface

- PC/104 expansion: 8/16-bit ISA, no support ISA DMA. If user needs booting/power from PC/104, supported by T-P/N)
- LPC connector:
 - Controller: ITE 8760E
 - LPC module: PCA-COM232-00A1E (4 RS-232 ports), PCA-COM485-00A1E (4 RS-422/485 ports), and PCA-TPM-00A1E. Only PCA-COM485 cannot use standard BIOS, supported by T-P/N
- 2 Serial-ATA ports, up to 3.0Gb/s (300 MB/s)
- 1 CompactFlash Card TYPE I/II socket (Primary Master IDE Channel)
- 4 USB 2.0 compliant ports
- 3 RS-232 from COM1/3/4, 1 RS-232/422/485 from COM2 (ESD protection: air gap ± 15 kV, contact ± 8 kV), support RS-485 auto flow control
- SMBus or I²C (auto detection)
- Support standard PC/AT keyboard and PS/2 mouse
- 8-bit programmable GPIO (General Purpose Input/Output) with 5V tolerance
- 1 Reset button
- Watchdog timer: 255 levels timer interval, programmable by software, multi-level WDT (set by iManager)
- Audio: Realtek ALC892, High Definition Audio, Line-in, Line-out, Mic-in

BIOS

- AMI 16Mbit SPI Flash ROM

OS Support

PCM-9389 supports Win7, Win XP, Win CE 6.0, WES7, WES, QNX 6.5, VxWorks 6.8, and Linux Ubuntu 10.04.

For further information about OS support, please visit Advantech website: www.advantech.com or contact with technical support center.

iManager

- Power Sequence: Control by iManager
- Power Saving:
 - Deep sleep S5 mode
 - Backlight control
 - Brightness control
- Hardware Monitor:
 - Battery voltage
 - Read CPU temperature
 - 5V, 12V, Vcore
- Multi-control Interface: GPIO, SMBus or I²C

- Watchdog Timer: Output system reset, programmable counter from 1-255 min/sec (set by iManager)
- Board Information:
 - Running hour
 - Booting record
- Security data area: 64 bytes on EEPROM for customer saving sensitive data

1.2.2 Mechanical Specifications

- Dimensions: 146 x 102 mm (5.7" x 4")
- Height:
 - Total: 26.2 mm for N455 (including of heatsink), 29.2 mm for D525 (including of cooler)
 - Top side: 15 mm for N455, 18 mm for D525 (PCB to heatsink/cooler)
 - Bottom side: 9.6 mm (PCB to CF socket). If stacking with Advantech LPC module, total bottom side 14.6 mm
- Reference Weight: 640 g (including whole package)

1.2.3 Electrical Specifications

- Power supply type: AT / ATX
- Power management: ACPI 3.0, APM
- Power requirement: +5 V \pm 5% (+12 V optional for PC/104 add-on module and LCD inverter)
 - AT: +5 V \pm 5%
 - ATX: +5 V \pm 5%, +5 Vsb
- Power consumption:

| | Voltage | N455 | | D525 | |
|-----------|---------|---------|--------|---------|--------|
| | | Current | Power | Current | Power |
| Idle mode | +5V | 1.63 A | 8.2 W | 1.94 A | 9.7 W |
| Power on | +5V | 2.03 A | 10.2 W | 2.52 A | 12.6 W |
| Max load | +5V | 2.23 A | 11.2 W | 2.90 A | 14.5 W |

- Power consumption test conditions:
 - Test software: 3DMark 2006
 - Power on - Boot: Measure the maximum current value between system power on and boot-up to OS
 - Max load: Measure the maximum current value when system is under maximum load (CPU with top speed, RAM & Graphic with full loading)
 - Idle mode: Measure the current value when system is on windows mode and without running any program
- RTC battery:
 - Typical voltage: 3.0 V
 - Normal discharge capacity: 210 mAh

1.3 Environmental Specifications

- Operating temperature: 0 ~ 60° C (32 ~ 140° F)
- Operating humidity: 40° C @95% RH Non-condensing
- Storage temperature: -40 ~ 85° C (-40 ~ 185° F)
- Storage humidity: 60° C @95% RH Non-condensing

1.4 Block Diagram

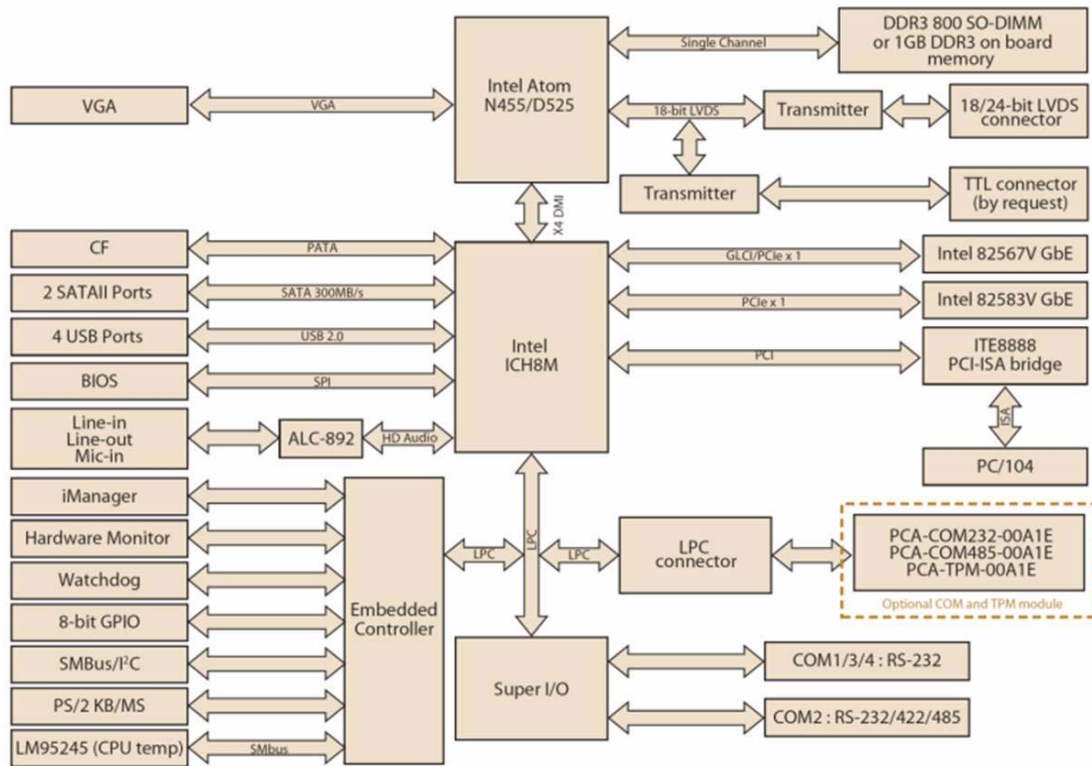

Figure 1.1 Block Diagram

Chapter 2

H/W Installation

This chapter explains the setup procedures of the PCM-9389 hardware, including instructions on setting jumpers and connecting peripherals, as well as switches, indicators and mechanical drawings. Be sure to read all safety precautions before you begin the installation procedure.

2.1 Jumpers

2.1.1 Jumper Description

Cards can be configured by setting jumpers. A jumper is a metal bridge used to close an electric circuit. It consists of two metal pins and a small metal clip (often protected by a plastic cover) that slides over the pins to connect them. To close a jumper, you connect the pins with the clip. To open a jumper, you remove the clip. Sometimes a jumper will have three pins, labeled 1, 2 and 3. In this case you would connect either pins 1 and 2, or 2 and 3.

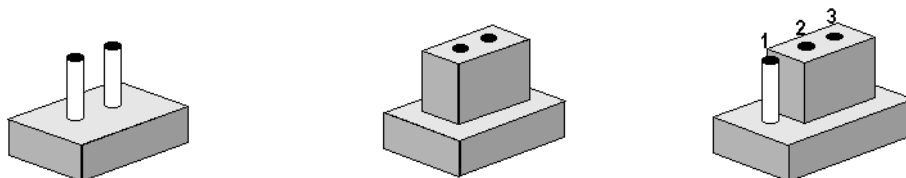

The jumper settings are schematically depicted in this manual as follows.



A pair of needle-nose pliers may be helpful when working with jumpers. If you have any doubts about the best hardware configuration for your application, contact your local distributor or sales representative before you make any changes.

Generally, you simply need a standard cable to make most connections.

Warning! To avoid damaging the computer, always turn off the power supply before setting jumpers.



2.1.2 Jumper List

Table 2.1: Jumper List

| | |
|----|----------------------------|
| J1 | AT/ATX power supply |
| J2 | COM2 RS-232/422/485 switch |
| J3 | LCD Power |

2.1.3 Jumper Settings

| | |
|-------------|--|
| J1 | AT/ATX power supply |
| Part Number | 1653002101 |
| Footprint | HD_2x1P_79_D |
| Description | PIN HEADER 2*1P 180D(M)SQUARE 2.0mm DIP W/O Pb |
| Setting | Function |
| NC | ATX |
| (1-2)* | AT |
| *: default | |

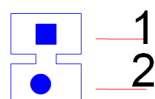

| | |
|-------------|--|
| J2 | COM2 RS-232/422/485 switch |
| Part Number | 1653003260 |
| Footprint | HD_3x2P_79 |
| Description | PIN HEADER 3x2P 2.0mm 180D(M) SMD 21N22050 |
| Setting | Function |
| (1-2)* | RS232 |
| (3-4) | RS485 |
| (5-6) | RS422 |
| *: default | |

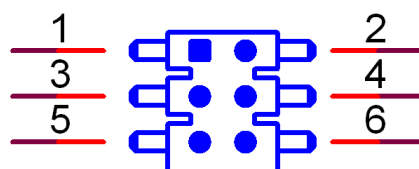

| | |
|-------------|--|
| J3 | LCD Power |
| Part Number | 1653003101 |
| Footprint | HD_3x1P_79_D |
| Description | PIN HEADER 3x1P 2.0mm 180D(M) DIP 2000-13 WS |
| Setting | Function |
| (1-2) | +5 V |
| (2-3)* | +3.3 V |
| *: default | |

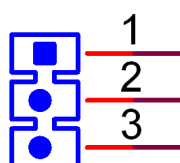

2.2 Connectors

2.2.1 Connector list

| Table 2.2: Connector List | |
|---------------------------|-----------------------|
| CN1 | AT/ATX Power Input |
| CN3 | DDR3 SODIMM socket |
| CN7 | Power Switch |
| CN8 | GPIO |
| CN9 | VGA |
| CN10 | CF socket |
| CN11 | HDD & PWR LED |
| CN12 | SATA |
| CN13 | SATA |
| CN14 | USB |
| CN15 | USB |
| CN16 | COM1: RS-232 |
| CN17 | COM2: RS-232 |
| CN18 | COM2: RS-422/485 |
| CN19 | COM3/COM4: RS-232 |
| CN20 | LPC |
| CN21 | PS/2 |
| CN22 | SMBus |
| CN23 | CPU FAN |
| CN24 | LAN1 (External) |
| CN25 | LAN2 (Internal) |
| CN26 | Audio |
| CN27 | PC/104 |
| CN28 | ISA -5V & -12V Input |
| CN29 | Inverter Power Output |
| CN30 | LVDS |
| CN31 | TTL (by request) |

2.2.2 Connector Settings

2.2.2.1 RTC Battery Connector (BH1)

PCM-9389 supports a lithium 3 V/210mAH CR2032 battery with wire via battery connector.

Note! *How to clear CMOS: (Must follow steps below)*



1. Turn off system power
2. Unplug battery cable on BH1
3. Wait for 15sec or short BH1 pin1-2
4. Plug battery cable on BH1
5. Turn on system power

2.2.2.2 AT/ATX Power Input (CN1)

Supplies main power +5 V to PCM-9389 via 6x2-pin connector, and to devices that require +12 V.

AT power cable is included in standard packing, but ATX power cable (P/N: 1700001112) is an optional accessory requiring additional order.

2.2.2.3 DDR3 SODIMM Socket (CN3)

One 204-pin/H9.2 mm DDR3 SODIMM socket supports DDRIII 667 MHz up to 2 GB for N455, 800 MHz up to 4 GB.

2.2.2.4 Power switch (CN7)

2-pin box wafer connector for power switch.

2.2.2.5 GPIO (General Purpose Input Output) (CN8)

PCM-9389 supports 8-bit GPIO (5 V tolerance) through this 5x2-pin box header connector. The 8 digital inputs and outputs can be programmed to read or control devices, with each input or output defined.

2.2.2.6 VGA (CN9)

The VGA interface is a standard 15-pin D-SUB connector as coastline for conventional CRT display.

Resolution: N455 up to 1400 x 1050 (SXGA), D525 up to 2048 x 1536.

2.2.2.7 CompactFlash Socket (CN10)

The CompactFlash card can be enabled/disabled via BIOS settings.

2.2.2.8 HDD & Power LED (CN11)

User needs a cable connected to this 6-pin box wafer to indicate:

- **Power LED (pin3 & pin4)**
Power LED indicator would light up when power is on.
- **HDD LED (pin5 & pin6)**
LDD LED indicator for hard disk access is an active low signal.

2.2.2.9 Reset Button (S1 at coastline)

Momentarily pressing the button will activate a reset.

2.2.2.10 SATA (CN12, CN13)

PCM-9389 features two high performance Serial ATA interface (up to 300 MB/s) via standard SATA 7-pin connectors.

SATA power cable is optional accessory, P/N: 1700018436.

2.2.2.11 USB 2.0 (CN14, CN15)

PCM-9389 provides two USB (Universal Serial Bus) 2.0 ports Plug and Play via 5x2-pin pin header connectors. The USB interface complies with high speed USB specification Rev. 2.0 which supports 480 Mbps transfer rate, and are fuse protected.

The USB interface can be disabled in the system BIOS setup.

2.2.2.12 COM Port (CN16, CN17, CN18, CN19)

PCM-9389 provides four serial ports: three RS-232 ports (COM1/3/4) and one RS-232/422/485 (COM2). It provides connections for serial devices or communication network. Pin assignment for COM ports can be found in Appendix A.

- **COM1: RS-232 (CN16)**
Connector: standard 9-pin D-SUB at coastline
- **COM2: RS-232/422/485 (CN17, CN18)**
Connector: RS-232 via 5x2-pin box header (CN17), RS-422/485 via 5-pin wafer (CN18)
Setting: User can select COM2 setting by J2. Closing pin1-2 for RS-232(default), pin3-4 for RS-485, pin5-6 for RS-422
- **COM3/4: RS-232 (CN19)**
Connector: 10x2-pin box header

2.2.2.13 LPC (Low Pin Count) (CN20)

Advantech provides three LPC modules to choose: PCA-COM232-00A1E, PCA-COM485-00A1E and PCA-TPM-00A1E (standard BIOS can not support PCA-COM485 due to storage space limit, supporting by T-P/N).

If using other LPC module, BIOS modification is needed.

Connector: 7x2-pin female header

2.2.2.14 PS/2 (CN21)

PCM-9389 provides a standard mini din 6-pin connector that supports both keyboard and PS/2 interface mouse.

2.2.2.15 SMBus (CN22)

PCM-9389 provides 4-pin wafer connector for customer connecting to SMBus or I²C protocol embedded device (auto detection).

Advantech also provides SMBus API allowing developer to interface with an embedded system environment and transfer serial messages using the SMBus protocols, allowing multiple simultaneous device control.

2.2.2.16 CPU fan (CN23)

PCM-9389 provides 3-pin box wafer connector for cooler's power supplying, and user can use it to supply system fan's power when choosing N455 sku.

2.2.2.17 Gigabit Ethernet (CN24, CN25)

- LAN1: Intel 82567V Gigabit Ethernet chip (PHY) via standard 8-pin phone jack RJ-45 connector with LED indicator. If transfer rate reaches 100Mbps would light green, up to 1000Mbps would be orange.
- LAN2: Intel 52583V Gigabit Ethernet chip via 5x2-pin box header connector.

2.2.2.18 Audio (CN26)

High Definition audio with Realtek ALC892 codec via 5x2-pin box header connector, supporting line-in/ line-out/ mic-in output.

2.2.2.19 PC/104 (CN27)

Standard 104-pin PC/104 short pin connector for 8/16-bit ISA, and PCM-9389 does not support ISA DMA. If user needs to boot up from PC/104 or with long pin PC/104, that can be supported by T-P/N.

2.2.2.20 ISA -5V & -12V Input (CN28)

PCM-9389 is equipped with a negative power input connector (3-pin pin header) to provide -5 V & -12 V power.

2.2.2.21 Inverter Power Output (CN29)

LCD inverter is connected to this 5-pin box wafer connector to provide +5 V / +12 V power.

User can select 3.3 V or 5 V for LCD power input via J3 setting.

2.2.2.22 LVDS (CN30)

The LVDS interface is a 10x2-pin board-to-board connector for single-channel 18/24-bit LVDS panel up to 1366 x 768 (WXGA).

Remark: If user's LVDS panel resolution is 640x480 and operates under DOS mode, please select LVDS+VGA dual display mode in BIOS to display correct screen size due to Intel VBIOS limitation.

2.2.2.23 TTL (CN31 supported by request)

The TTL interface is a 20x2-pin board-to-board connector for 18-bit TTL panel. TTL is supported by T-P/N.

2.3 Mechanical

2.3.1 Jumper and Connector Locations

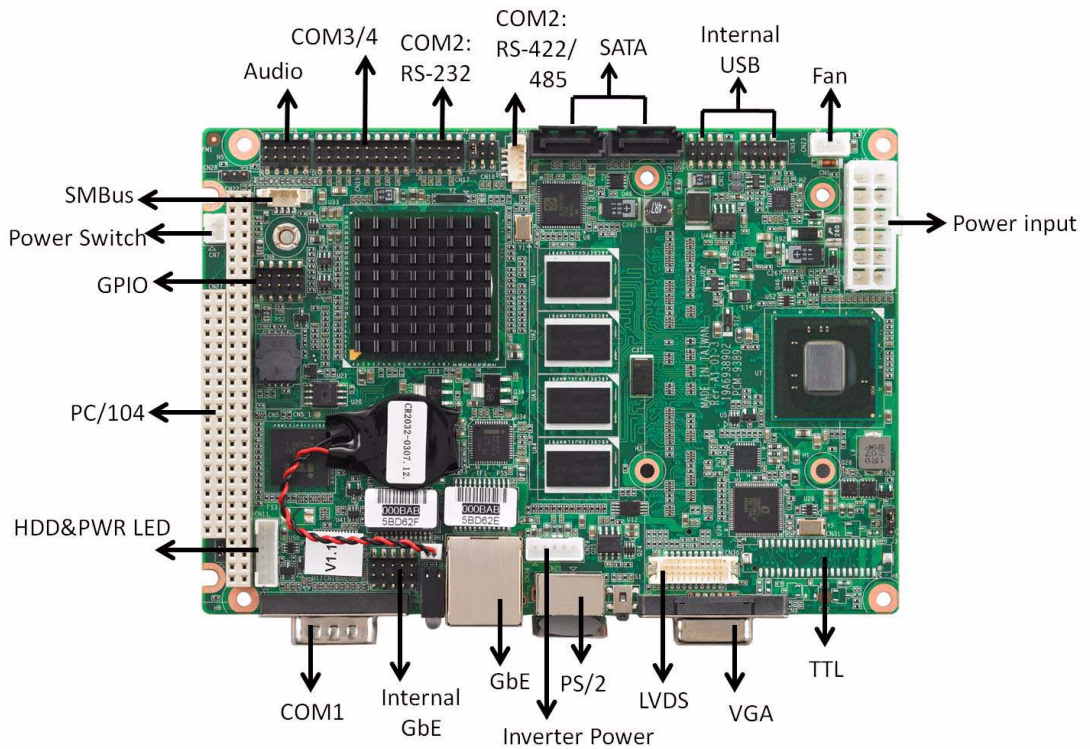

Figure 2.1 Jumper and Connector Layout (Top Side)

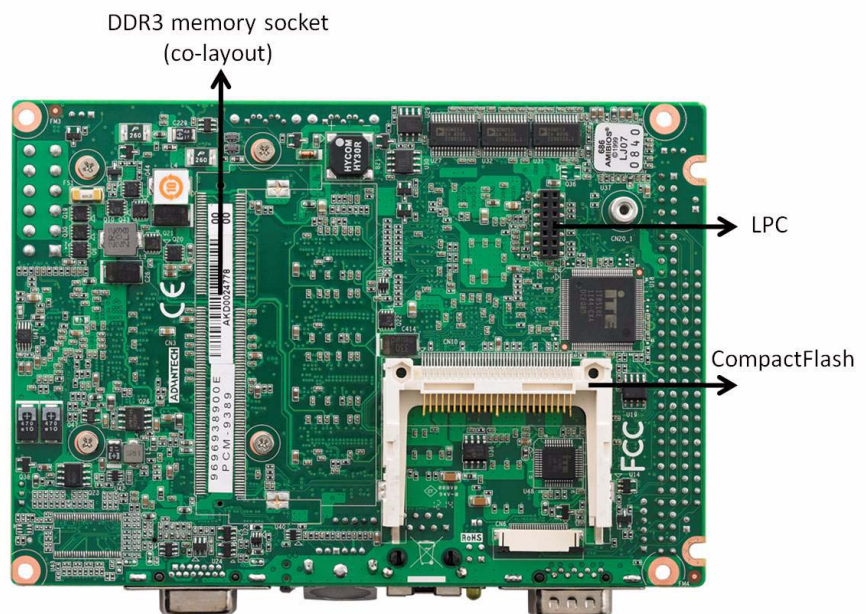

Figure 2.2 Jumper and Connector Layout (Bottom Side)



Figure 2.3 Coastline Layout

2.3.2 Board Dimensions

2.3.2.1 CPU Board Drawing

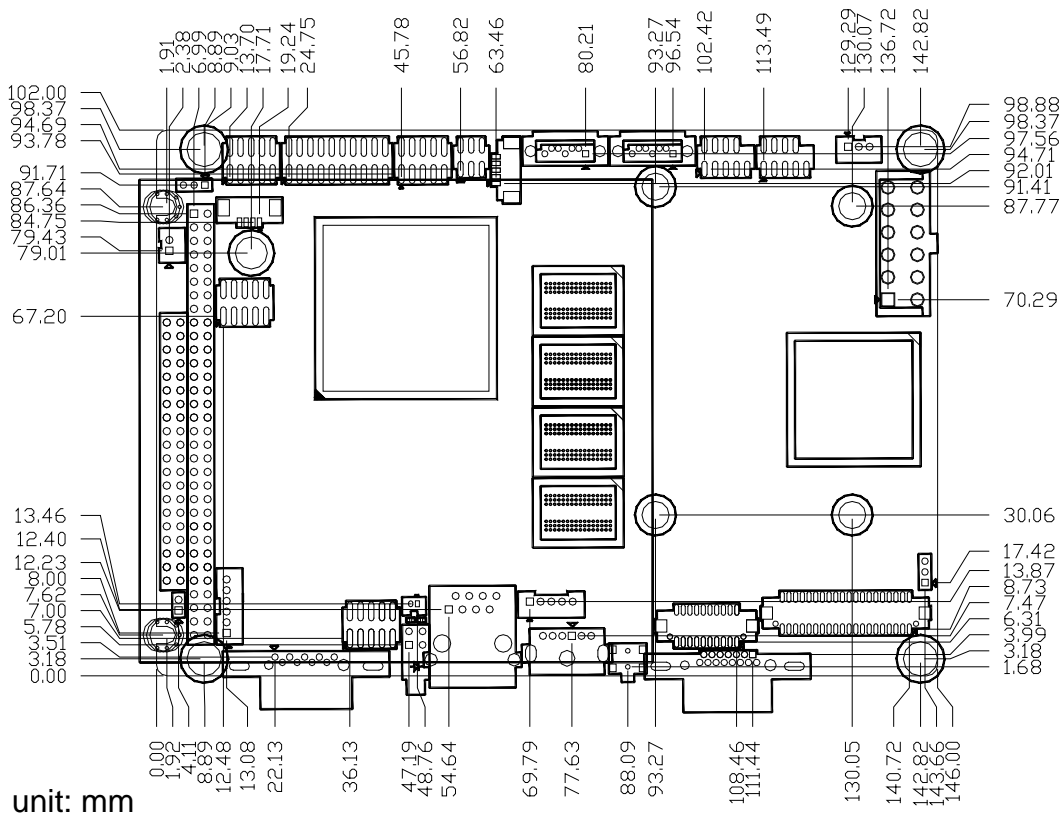
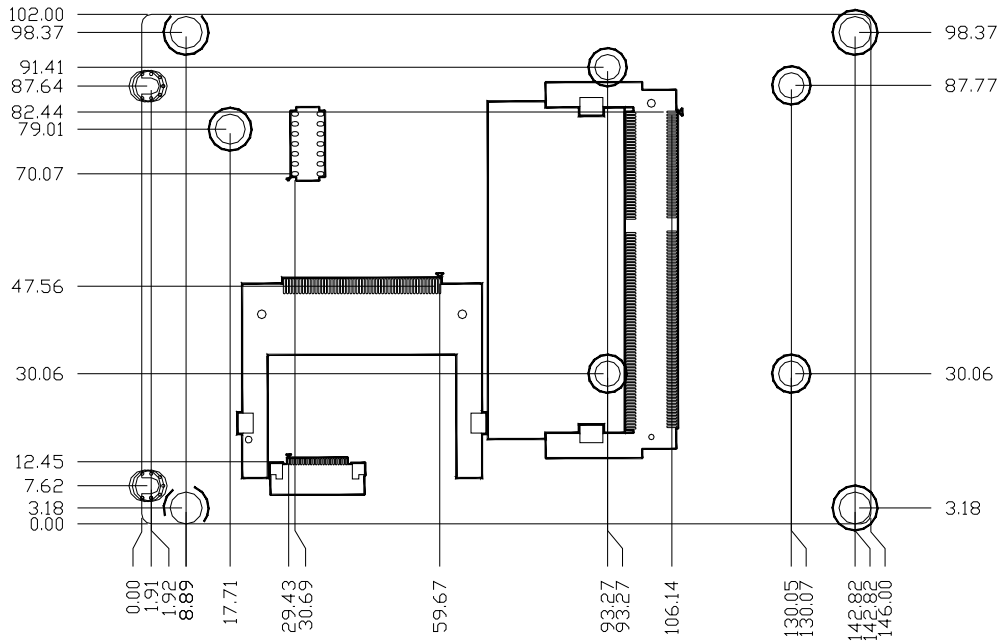
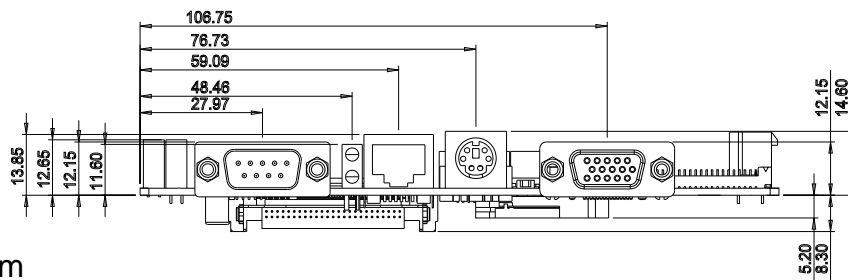

Figure 2.4 Board Dimension Layout (Top Side)



unit: mm

Figure 2.5 Board Dimension Layout (Bottom Side)



unit: mm

Figure 2.6 Board Dimension Layout (Coastline)

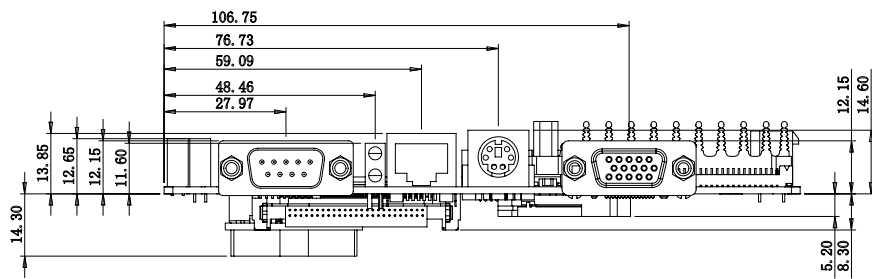

unit: mm

Figure 2.7 Board Dimension Layout (Coastline Including of LPC Module)

2.3.2.2 Another Thermal Solution - Heat Spreader

PCM-9389 has an optional heat spreader which can make the whole system more compact. Using a heat spreader to conduct heat to your chassis can help a lot when the system is extra compact or has limited space for heat convection. Here are some guidelines for a heat spreader:

1. For best heat conduction, the gap between the chassis and the heat spreader should be small; in fact, the smaller, the better. There is a thermal grease pack included with Advantech's heat spreader.
2. The height of existing heat spreader is 15 mm (P/N: 1960056151N001). If you need some other height to fit chassis better, Advantech could customize it. (Please contact our salespeople for details.)

Chapter 3

BIOS Settings

AMIBIOS has been integrated into many motherboards for over a decade. With the AMIBIOS Setup program, you can modify BIOS settings and control the various system features. This chapter describes the basic navigation of the PCM-9389 BIOS setup screens.

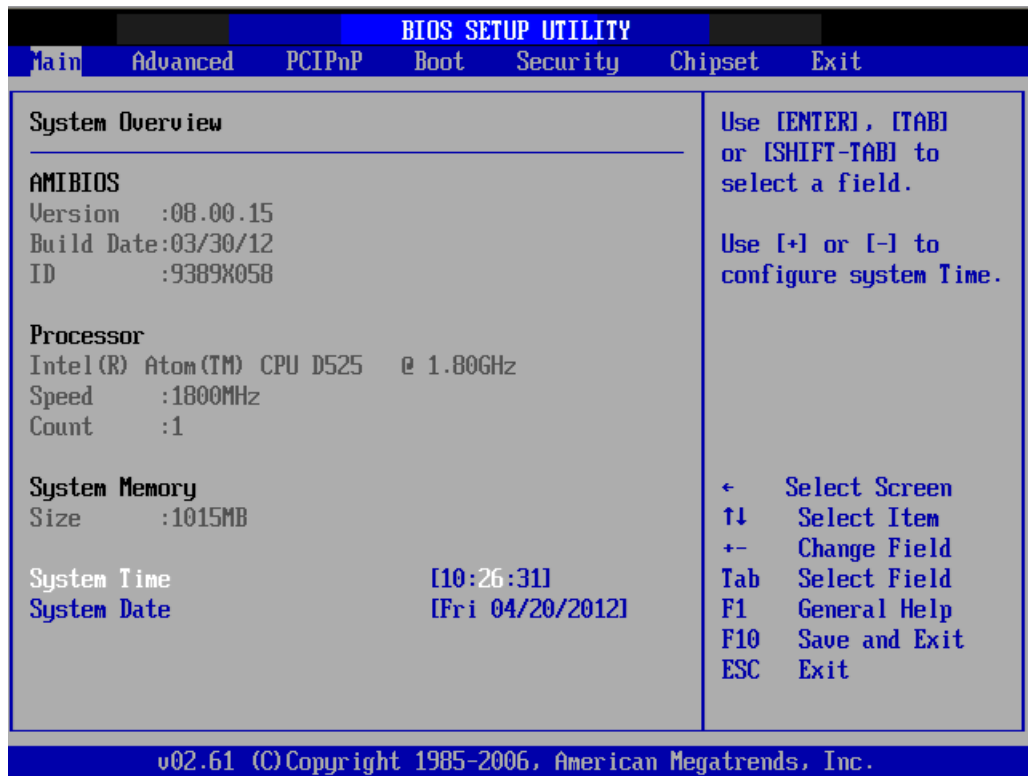

Figure 3.1 Setup Program Initial Screen

AMI's BIOS ROM has a built-in Setup program that allows users to modify the basic system configuration. This information is stored in battery-backed CMOS so it retains the Setup information when the power is turned off.

3.1 Entering Setup

Turn on the computer and check for the "patch" code. If there is a number assigned to the patch code, it means that the BIOS supports your CPU. If there is no number assigned to the patch code, please contact an Advantech application engineer to obtain an up-to-date patch code file. This will ensure that your CPU's system status is valid. After ensuring that you have a number assigned to the patch code, press and you will immediately be allowed to enter Setup.

3.2 Main Setup

When you first enter the BIOS Setup Utility, you will enter the Main setup screen. You can always return to the Main setup screen by selecting the Main tab. There are two Main Setup options. They are described in this section. The Main BIOS Setup screen is shown below.

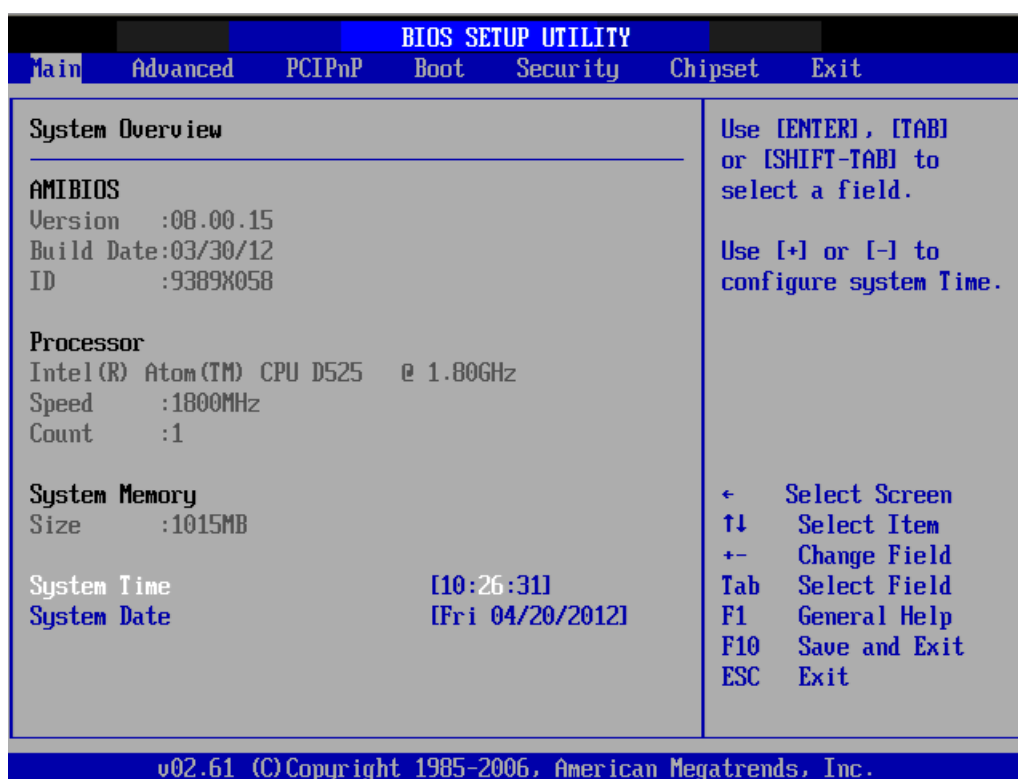

Figure 3.2 Main Setup Screen

The Main BIOS setup screen has two main frames. The left frame displays all the options that can be configured. Grayed-out options cannot be configured; options in blue can. The right frame displays the key legend.

Above the key legend is an area reserved for a text message. When an option is selected in the left frame, it is highlighted in white. Often a text message will accompany it.

3.2.1 System Time / System Date

Use this option to change the system time and date. Highlight System Time or System Date using the <Arrow> keys. Enter new values through the keyboard. Press the <Tab> key or the <Arrow> keys to move between fields. The date must be entered in MM/DD/YY format. The time must be entered in HH:MM:SS format.

3.3 Advanced BIOS Features Setup

Select the Advanced tab from the PCM-9389 setup screen to enter the Advanced BIOS Setup screen. You can select any of the items in the left frame of the screen, such as CPU Configuration, to go to the sub menu for that item. You can display an Advanced BIOS Setup option by highlighting it using the <Arrow> keys. All Advanced BIOS Setup options are described in this section. The Advanced BIOS Setup screens is shown below. The sub menus are described on the following pages.

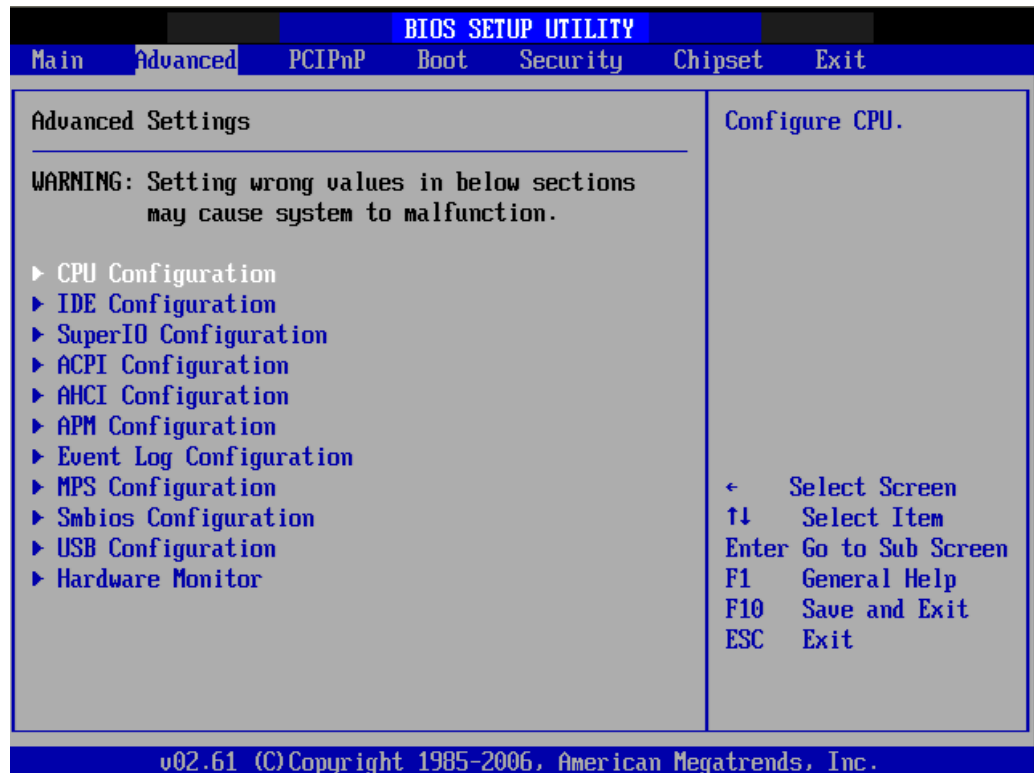

Figure 3.3 Advanced BIOS Features Setup Screen

3.3.1 CPU Configuration

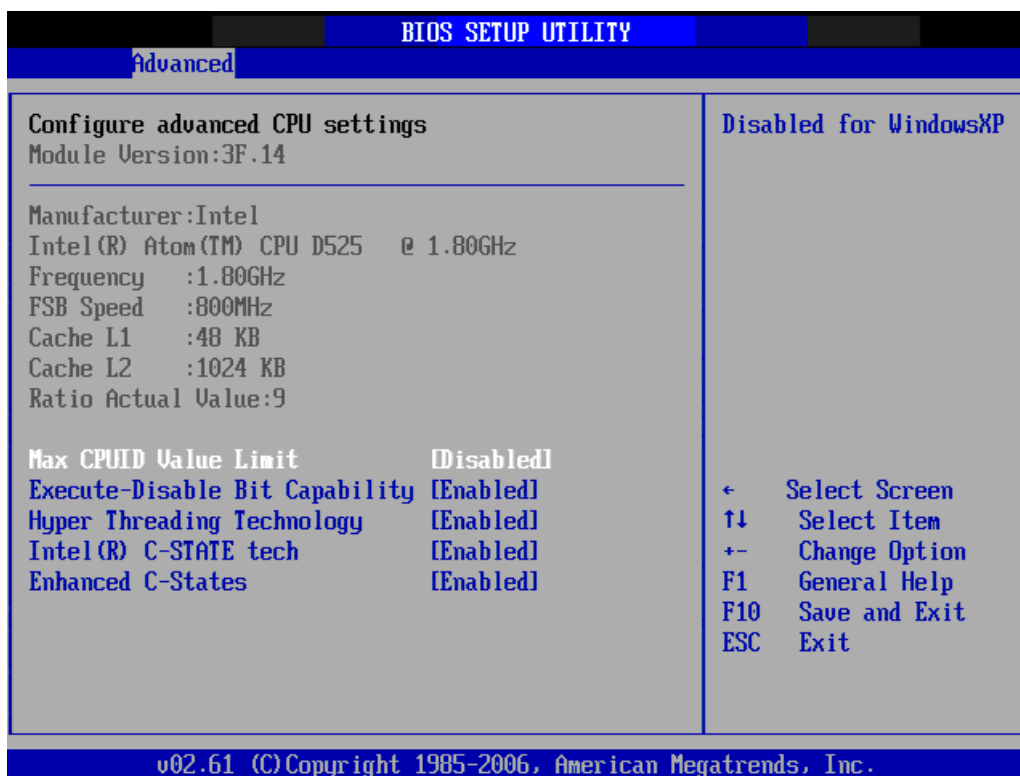

Figure 3.4 CPU Configuration Setting

- **Max CPUID Value Limit**
This item allows you to limit CPUID maximum value.
- **Execute-Disable Bit Capability**
This item allows you to enable or disable the No-Execution page protection technology.
- **Hyper Threading Technology**
This item allows you to enable or disable Intel? Hyper Threading technology.
- **Intel® C-STATE tech**
This item allows the CPU to save more power under idle mode.
- **Enhanced C-States**
CPU idle set to enhanced C-States, disabled by Intel® C-STATE tech item.

3.3.2 IDE Configuration

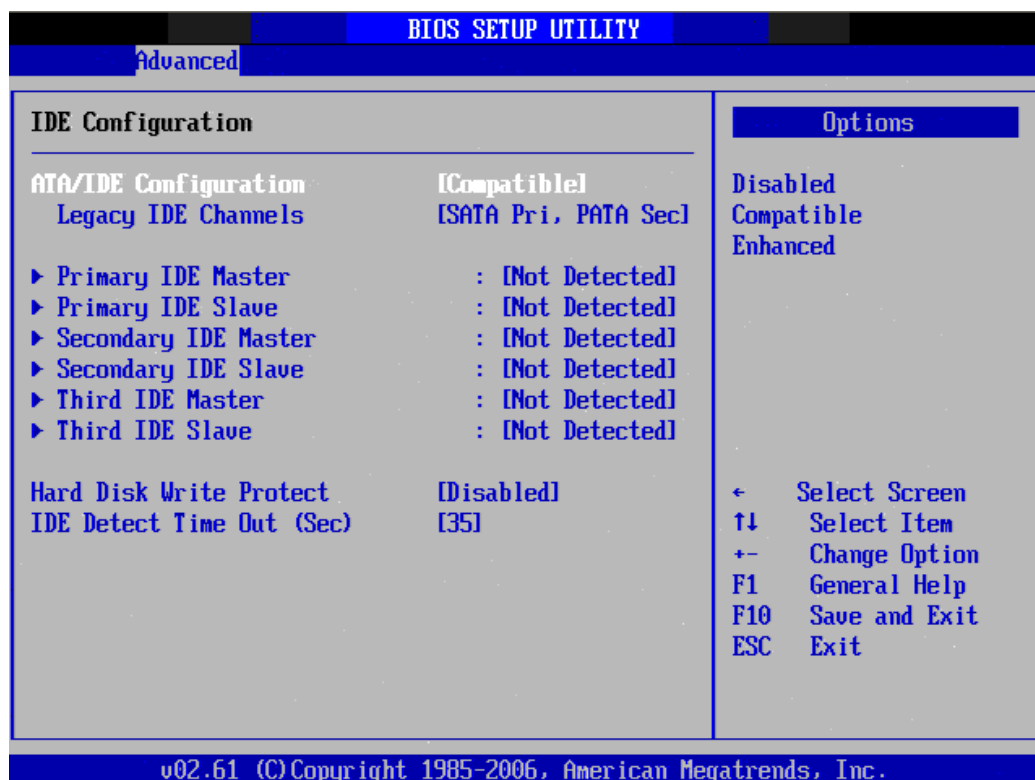

Figure 3.5 IDE Configuration

- **ATA/IDE Configuration**
This item allows you to select Disabled / Compatible / Enhanced.
- **Legacy IDE Channels**
When set to Enhanced mode you can select IDE or AHCI mode. When select Compatible mode you can select SATA only / SATA pri, PATA sec or PATA only.
- **Primary/Secondary/Third IDE Master/Slave**
BIOS auto detects the presence of IDE device, and displays the status of auto detection of IDE device.
 - Type: Select the type of SATA driver.[Not Installed][Auto][CD/DVD][ARMD]
 - LBA/Large Mode: Enables or Disables the LBA mode.
 - Block (Multi-Sector Transfer): Enables or disables data multi-sectors transfers.
 - PIO Mode: Select the PIO mode.
 - DMA Mode: Select the DMA mode.
 - S.M.A.R.T.: Select the smart monitoring, analysis, and reporting technology.
 - 32Bit Data Transfer: Enables or disables 32-bit data transfer.
- **Hard Disk Write Protect**
Disable/Enable device write protection. This will be effective only if device is accessed through BIOS.
- **IDE Detect Time Out (Sec)**
This item allows you to select the time out value for detecting ATA/ATAPI device(s).

3.3.3 Super I/O Configuration

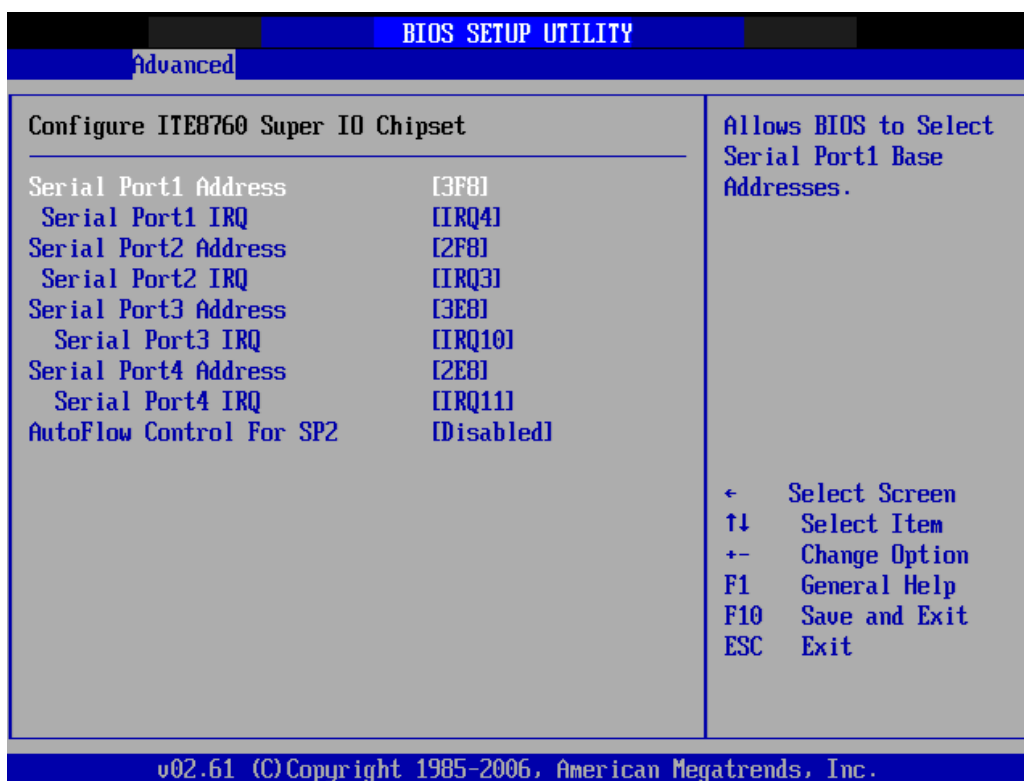

Figure 3.6 Super I/O Configuration

- **Serial Port1 / Port2 / Port3 / Port4 address**
This item allows you to select serial port1 ~ port4 of base addresses.
- **Serial Port1 / Port2 / Port3 / Port4 IRQ**
This item allows you to select serial port1 ~ port4 of IRQ.
- **Auto Flow Control For SP2**
This item allows you to enable or disable auto flow control function.

3.3.4 Hardware Monitor Configuration

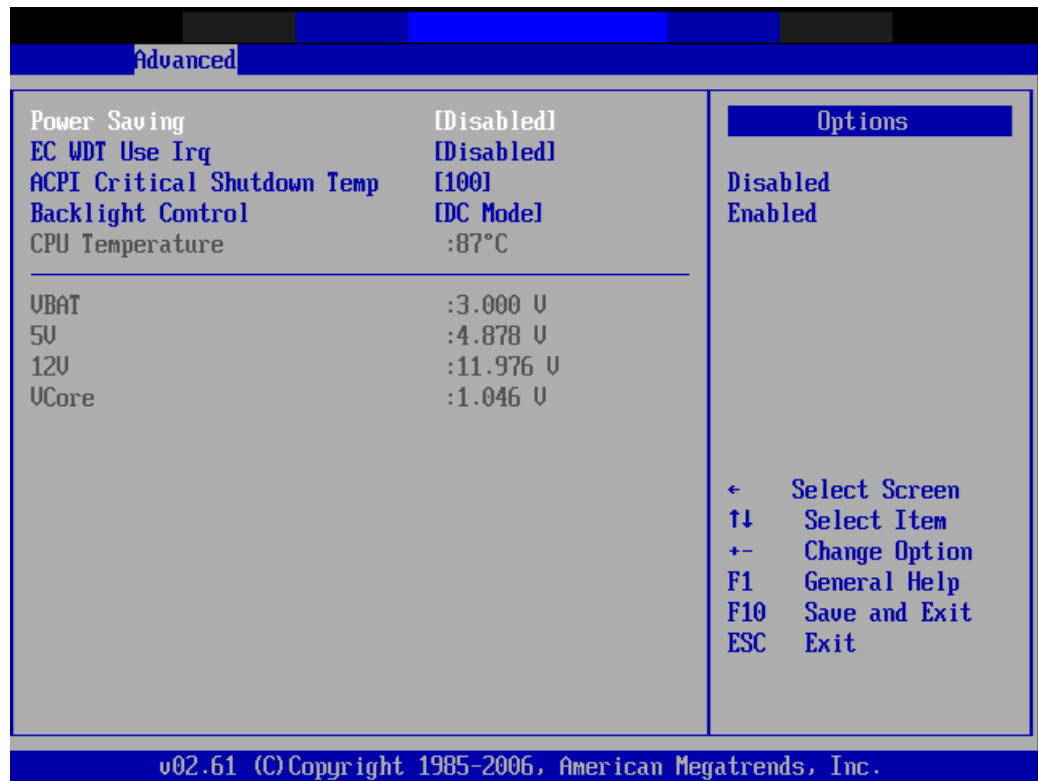

Figure 3.7 Hardware Health Configuration

- **Power Saving**
This item allows you to enable the power saving function.
- **EC WDT Use Irq**
This item allows you to select which EC WDT IRQ you want to use.
- **APCI Critical Shutdown Temp**
This item allows you to select shutdown temperature.
- **Backlight Control**
This item allows you to select backlight control type.
- **CPU Temperature**
Shows current CPU temperature.
- **VBAT / 5V / 12V / Vcore**
Displays voltages.

3.3.5 ACPI Settings

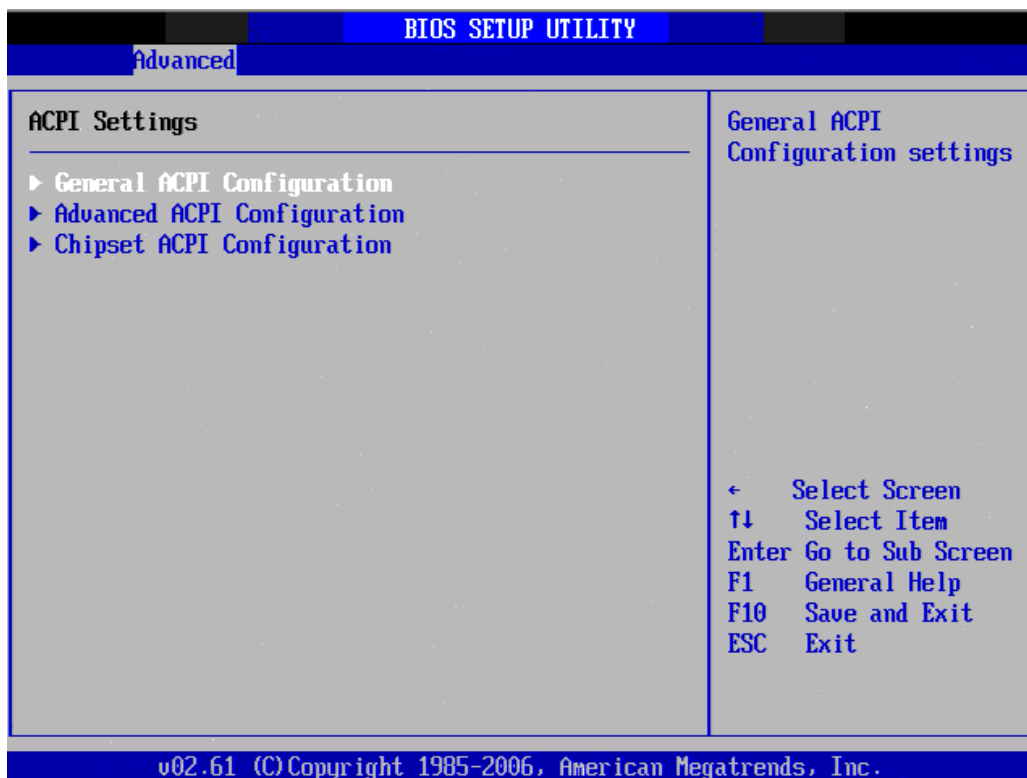

Figure 3.8 ACPI Settings

3.3.5.1 General ACPI Configuration

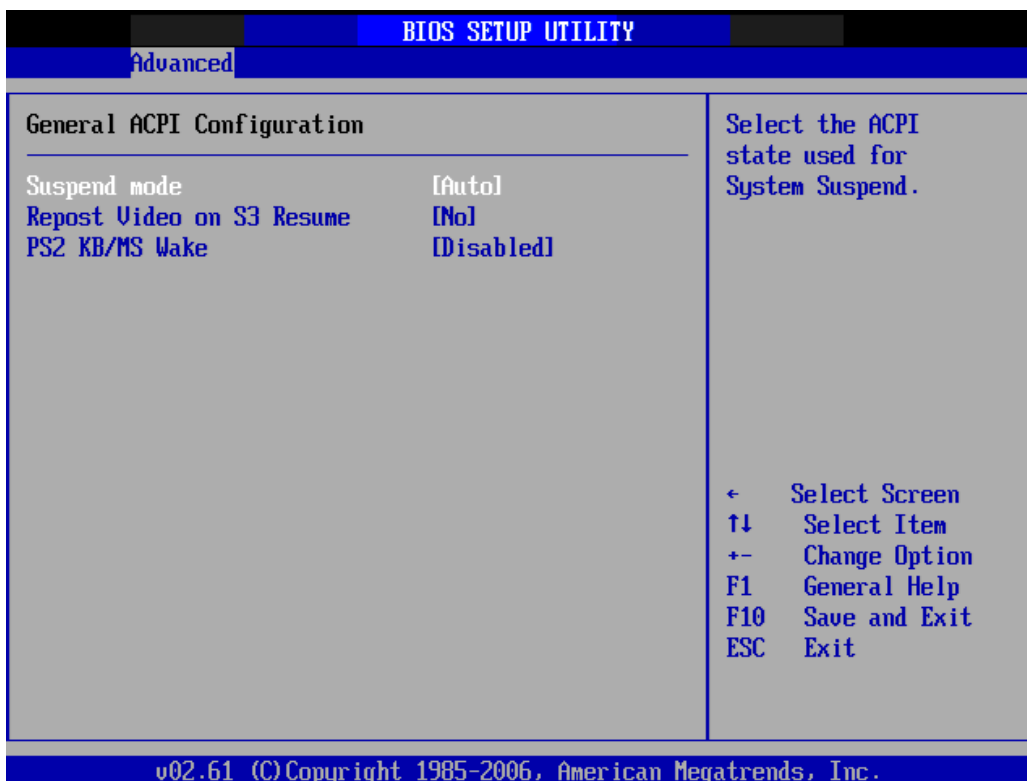

Figure 3.9 General ACPI Configuration

- **Suspend mode**
Select the ACPI state used for system suspend.
- **Report Video on S3 Resume**
This item allows you to invoke VA BIOS POST on S3/STR resume.
- **PS2 KB/MS Wake**
This item allows you to enable PS2 KB/MS wake up function.

3.3.5.2 Advanced ACPI Configuration

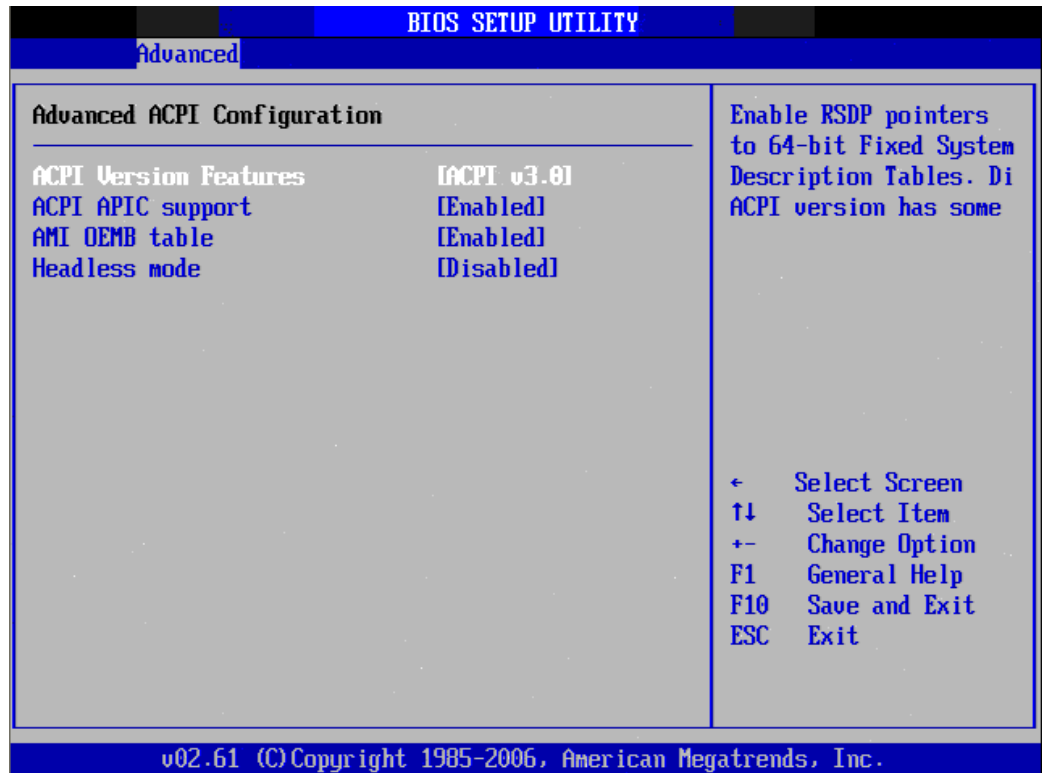

Figure 3.10 Advanced ACPI Configuration

- **ACPI Version Features**
This item allows you to enable RSDP pointers to 64-bit fixed system description tables.
- **ACPI APIC support**
Include APIC table pointer to RSDT pointer list.
- **AMI OEMB table**
Include OEMB table pointer to R(x)SDT pointer lists.
- **Headless mode**
Enable / Disable Headless operation mode through ACPI.

3.3.5.3 Chipset ACPI Configuration

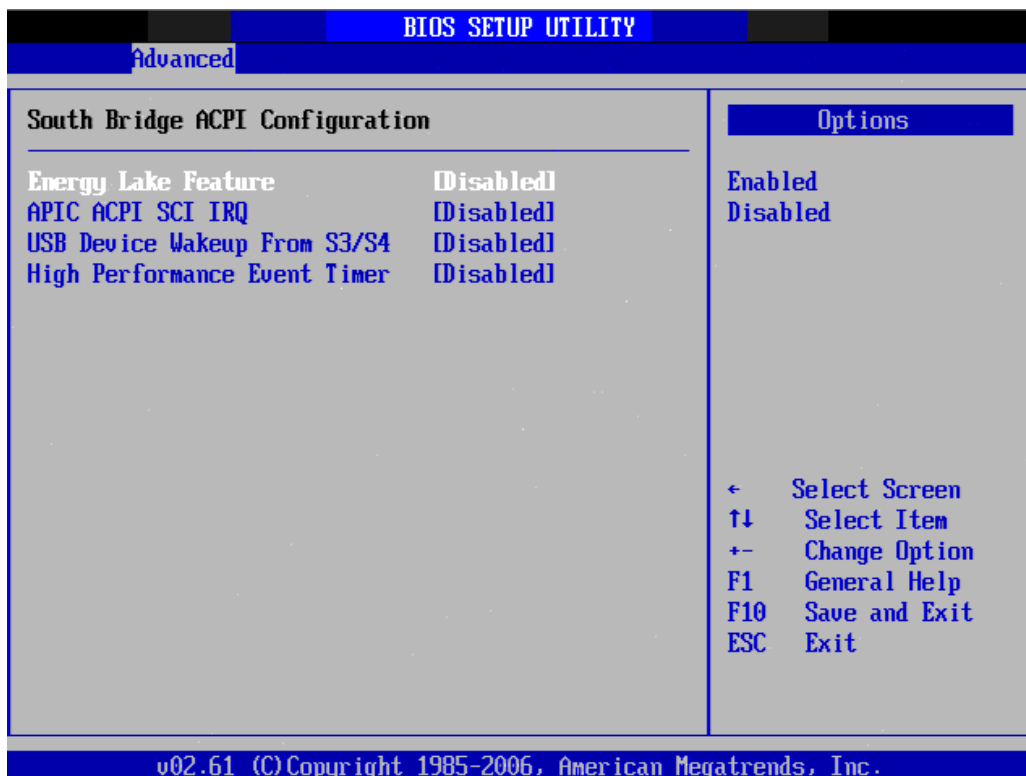

Figure 3.11 Chipset ACPI Configuration

- **Energy Lake Feature**
Allows you to configure Intel's Energy Lake power management technology.
- **APIC ACPI SCI IRQ**
Enable/Disable APIC ACPI SCI IRQ.
- **USB Device Wakeup From S3**
Enable/Disable USB Device Wakeup from S3.
- **High Performance Event Timer**
Enable/Disable High performance Event timer.

3.3.6 AHCI Configuration

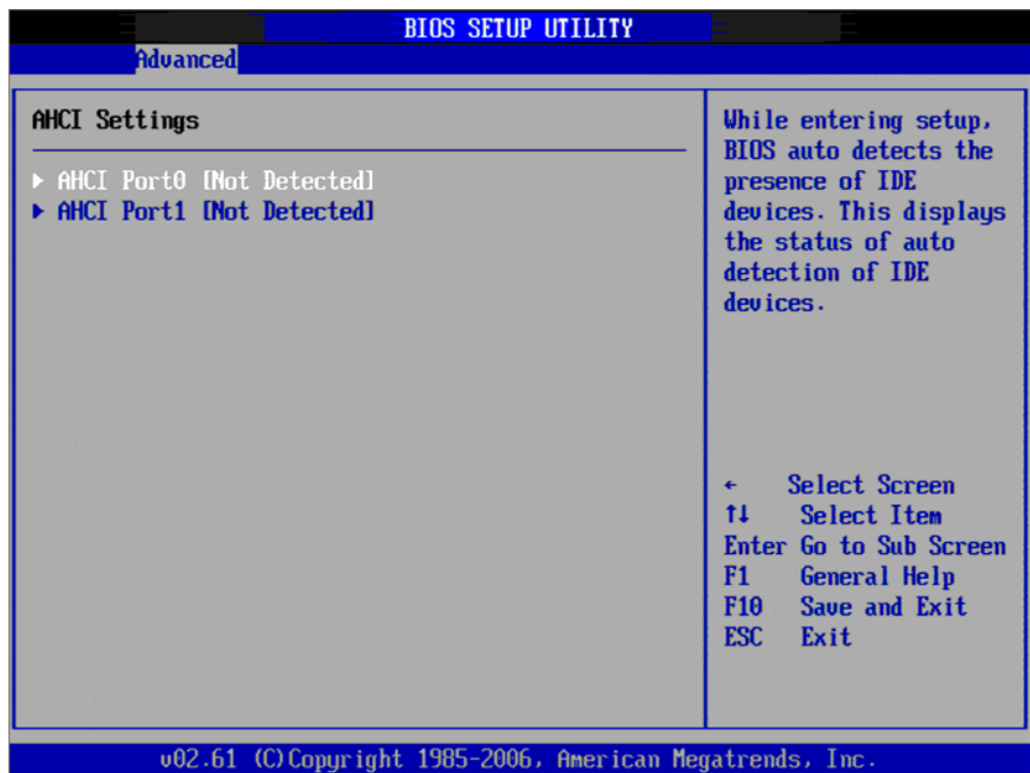

Figure 3.12 Advanced ACPI Configuration

- **AHCI Ports0 / Port1**
While entering setup, BIOS auto detects the presence of IDE devices. This displays the status of auto detection of IDE device.

3.3.7 APM Configuration

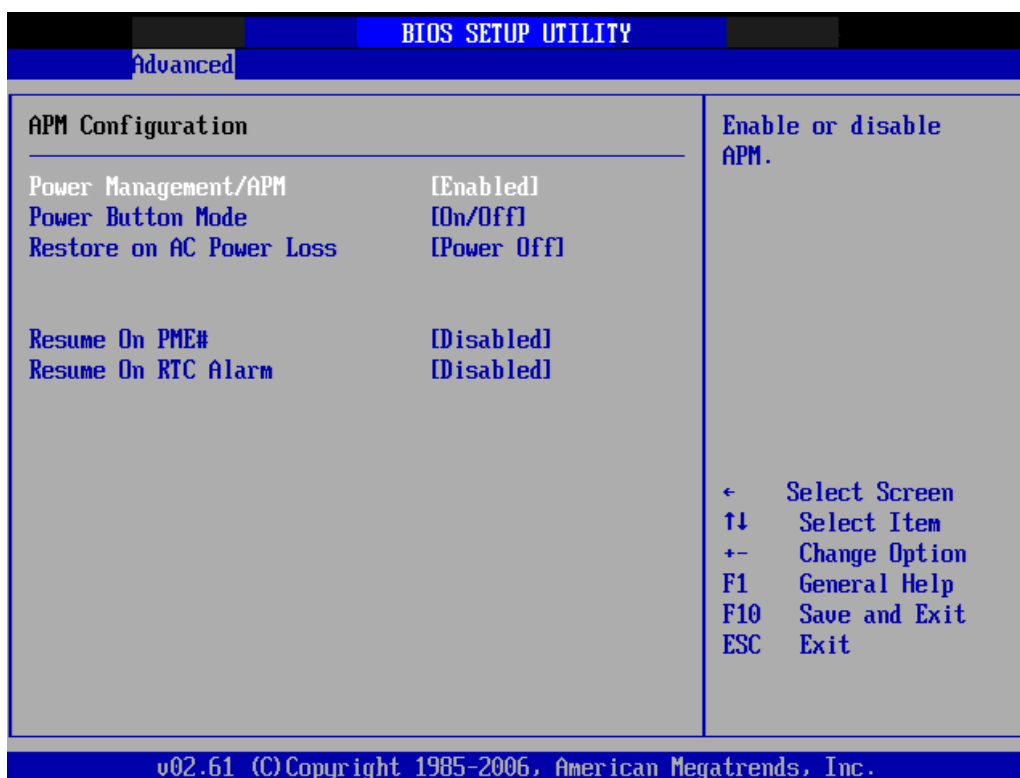

Figure 3.13 APM Configuration

- **Power Management/APM**
Enable or disable APM.
- **Power Button Mode**
Power on, off, or enter suspend mode when the power button is pressed. The following options are also available.
- **Restore on AC power Loss**
Use this to set up the system response after a power failure. The "Off" setting keeps the system powered off after power failure, the "On" setting boots up the system after failure, and the "Last State" returns the system to the status just before power failure.
- **Resume On PME#**
Enable / Disable PME to generate a wake event.
- **Resume On RTC Alarm**
Enable / Disable RTC to generate a wake event.

3.3.8 Event Log Configuration

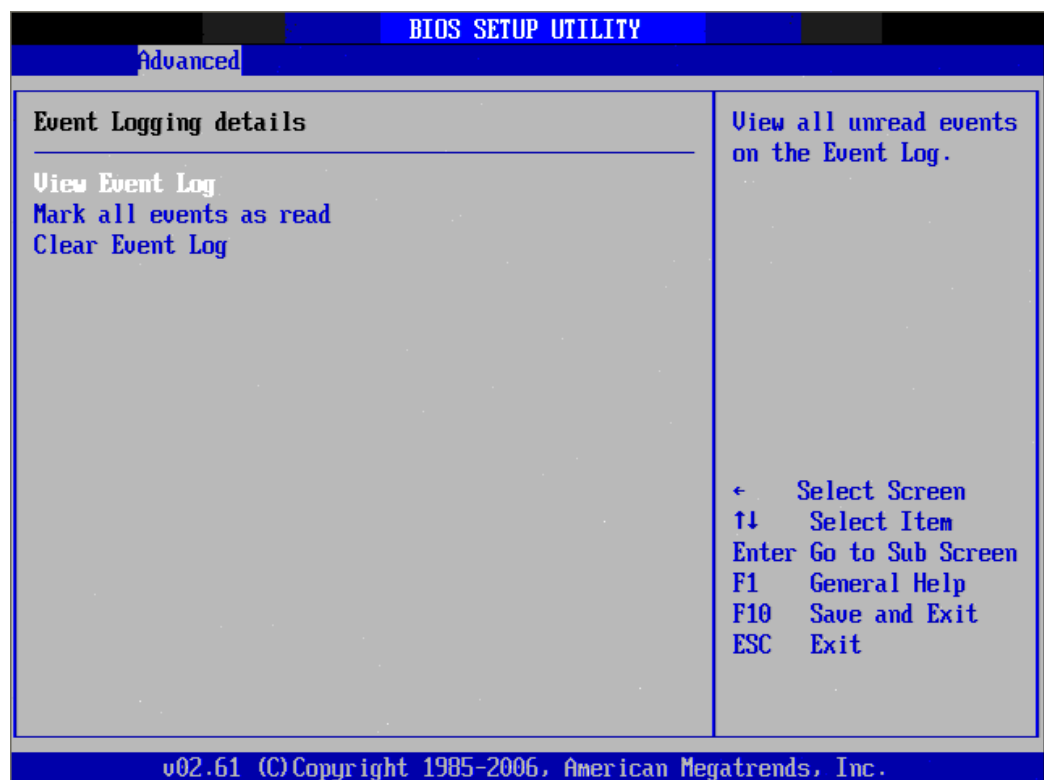

Figure 3.14 South Bridge ACPI Configuration

- **View Event Log**
View all unread events on the event Log.
- **Mark all events as read**
Mark all unread events as read.
- **Clear Event Log**
Discard all events in the event Log.

3.3.9 MPS Configuration

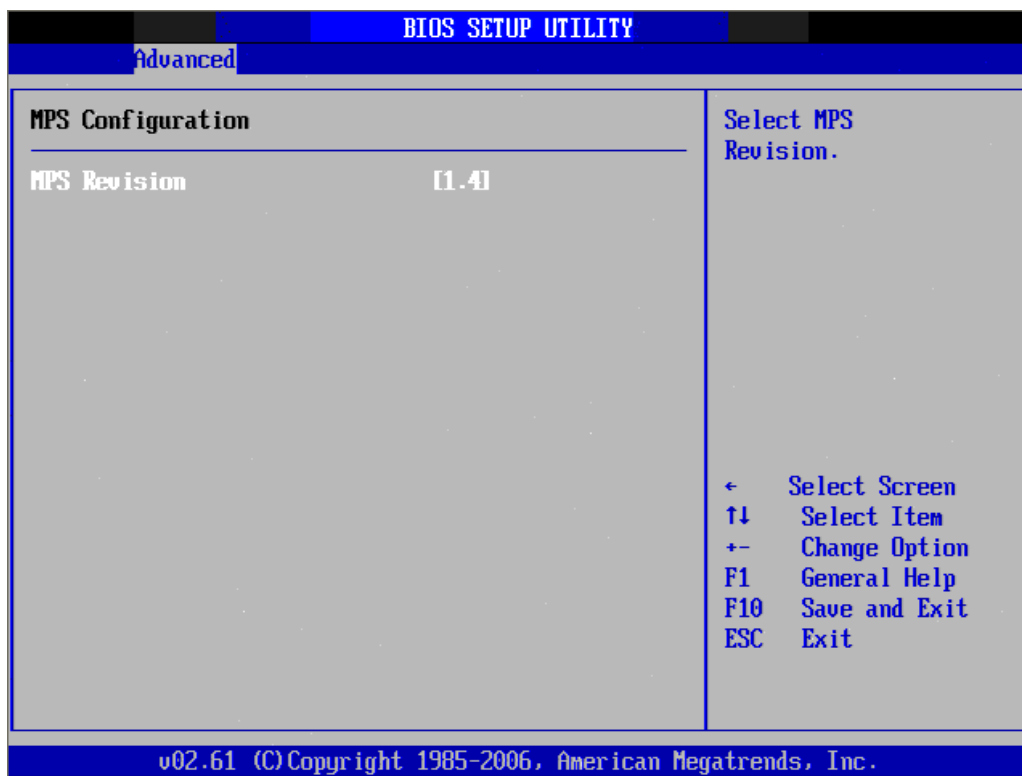

Figure 3.15 South Bridge ACPI Configuration

- **MPS Revision**
This item allows you to select MPS version.

3.3.10 Smbios Configuration

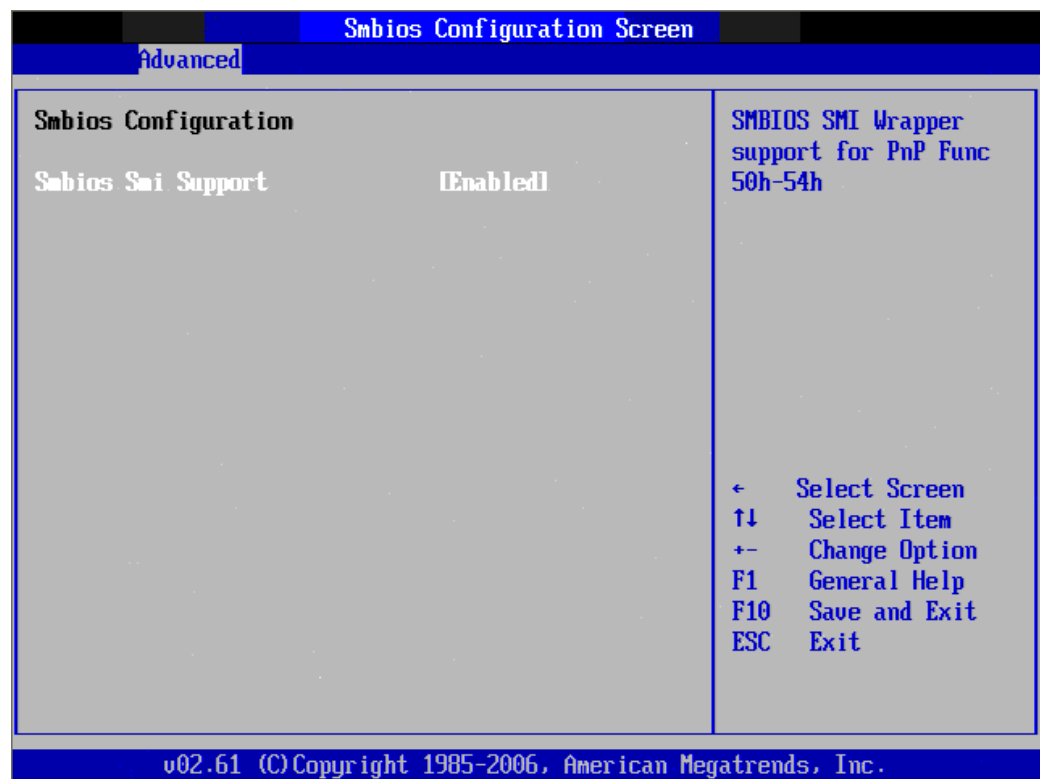

Figure 3.16 South Bridge ACPI Configuration

- **Smbios Smi Support**
SMBIOS SMI wrapper support for PnP function 50h-54h.

3.3.11 USB Configuration

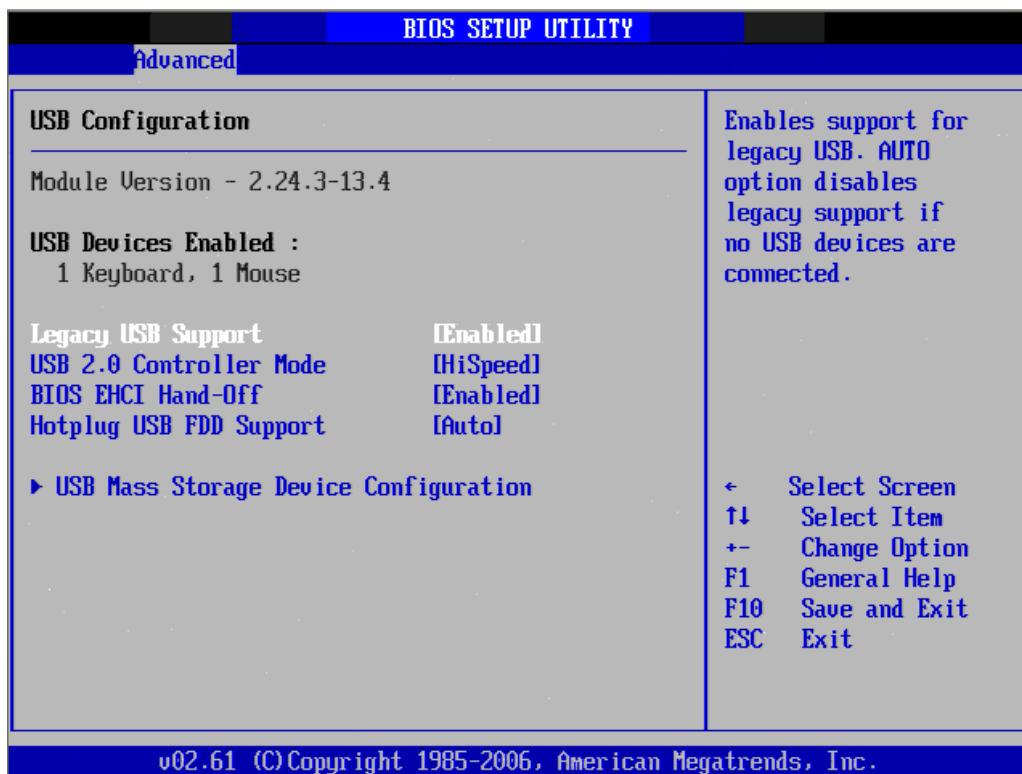

Figure 3.17 South Bridge ACPI Configuration

- **Legacy USB Support**
Enables support for legacy USB. Auto option disables legacy support if no USB devices are connected.
- **USB 2.0 Controller Mode**
This item allows you to select HiSpeed(480Mbps) or FullSpeed (12Mbps).
- **BIOS EHCI Hand-Off**
This is a workaround for OSeS without EHCI hand-off support. The EHCI ownership change should claim by EHCI driver.
- **Hotplug USB FDD Support**
A dummy FDD device is created that will be associated with the hotplugged FDD later. Auto option creates this dummy device only if there is no USB FDD present.

3.3.11.1 USB Mass Storage Device Configuration

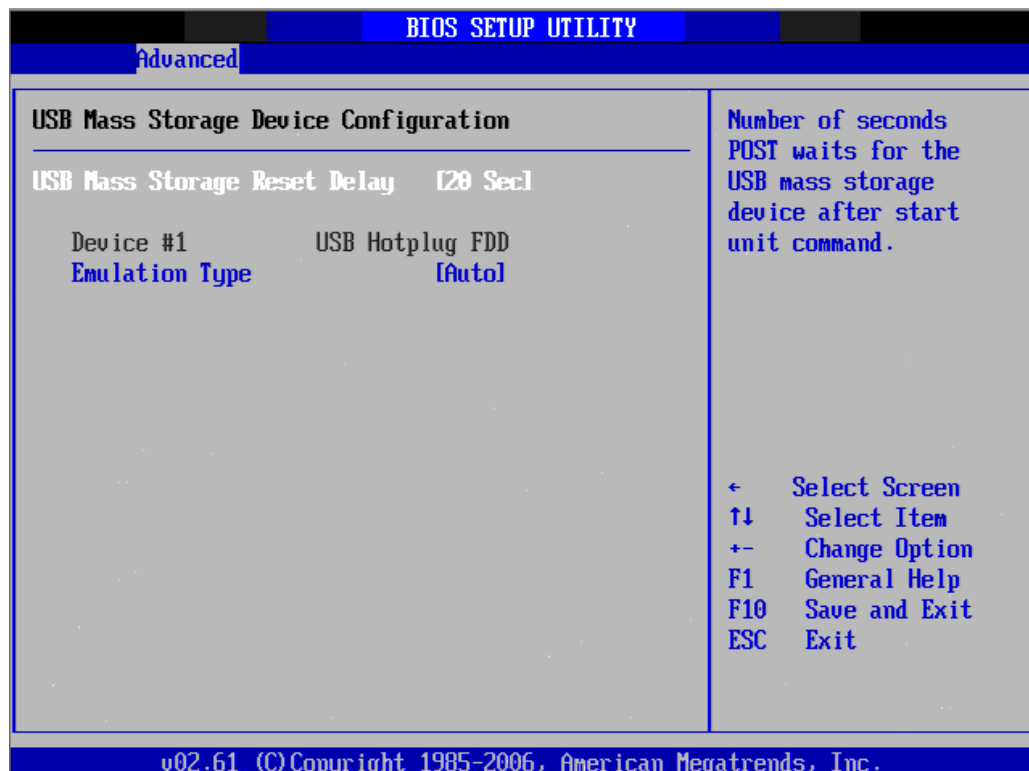

Figure 3.18 USB Mass storage Device Configuration

- **USB Mass Storage Reset Delay**
Number of sends POST wait for the USB mass storage device after start unit command.
- **Emulation Type**
If Auto, USB devices less than 530MB will be emulated as Floppy and remaining as hard drive. Force FDD option can be used to force a FDD formatted drive to boot as FDD (Ex. ZIP drive).

3.4 Advanced PCI/PnP Settings

Select the PCI/PnP tab from the PCM-9389 setup screen to enter the Plug and Play BIOS Setup screen. You can display a Plug and Play BIOS Setup option by highlighting it using the <Arrow> keys. All Plug and Play BIOS Setup options are described in this section. The Plug and Play BIOS Setup screen is shown below.

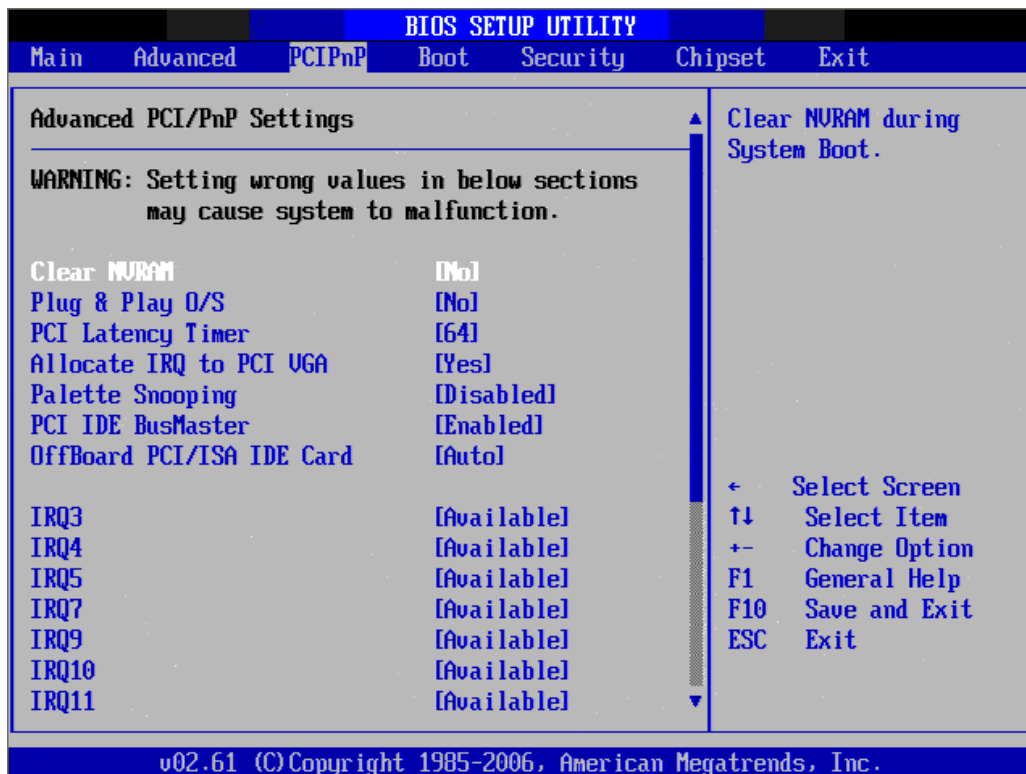

Figure 3.19 PCI/PNP Setup (Top)

- **Clear NVRAM**
Set this value to force the BIOS to clear the Non-Volatile Random Access Memory (NVRAM). The Optimal and Fail-Safe default setting is No.
- **Plug & Play O/S**
When set to No, BIOS configures all the device in the system. When set to Yes and if you install a Plug and Play operating system, the operating system configures the Plug and Play device not required for boot.
- **PCI Latency Timer**
Value in units of PCI clocks for PCI device latency timer register.
- **Allocate IRQ to PCI VGA**
When set to Yes will assigns IRQ to PCI VGA card if card requests IRQ. When set to No will not assign IRQ to PCI VGA card even if card requests an IRQ.
- **Palette Snooping**
This item is designed to solve problems caused by some non-standard VGA card.
- **PCI IDE BusMaster**
When set to enabled BIOS uses PCI busmastering for reading/writing to IDE drives.
- **OffBoard PCI/ISA IDE Card**
Some PCI IDE cards may require this to be set to the PCI slot number that is holding the card. When set to Auto will works for most PCI IDE cards.

- **IRQ3 / 4 / 5 / 7 / 9 / 10 / 11**
This item allows you respectively assign an interruptive type for IRQ-3, 4, 5, 7, 9, 10, 11.
- **DMA Channel0 / 1 / 3 / 5 / 6 / 7**
When set to Available will specified DMA is available to be used by PCI/PnP devices. When set to Reserved will specified DMA will Reserved for use by legacy ISA devices.
- **Reserved Memory Size**
This item allows you to reserved size of memory block for legacy ISA device.

3.5 Boot Settings



Figure 3.20 Boot Setup Utility

3.5.1 Boot settings Configuration



Figure 3.21 Boot Setting Configuration

- **Quick Boot**
This item allows BIOS to skip certain tests while booting. This will decrease the time needed to boot the system.
- **Quiet Boot**
If this option is set to Disabled, the BIOS displays normal POST messages. If Enabled, an OEM Logo is shown instead of POST messages.
- **AddOn ROM Display Mode**
Set display mode for option ROM.
- **Bootup Num-Lock**
Select the Power-on state for Numlock.
- **PS/2 Mouse Support**
Select support for PS/2 Mouse.
- **Wait For "F1" If Error**
Wait for the F1 key to be pressed if an error occurs.
- **Hit "DEL" Message Display**
Displays -Press DEL to run Setup" in POST.
- **Interrupt 19 Capture**
This item allows option ROMs to trap interrupt 19.
- **Bootsafe function**
This item allows you to enable or disable bootsafe function.

3.6 Security Setup

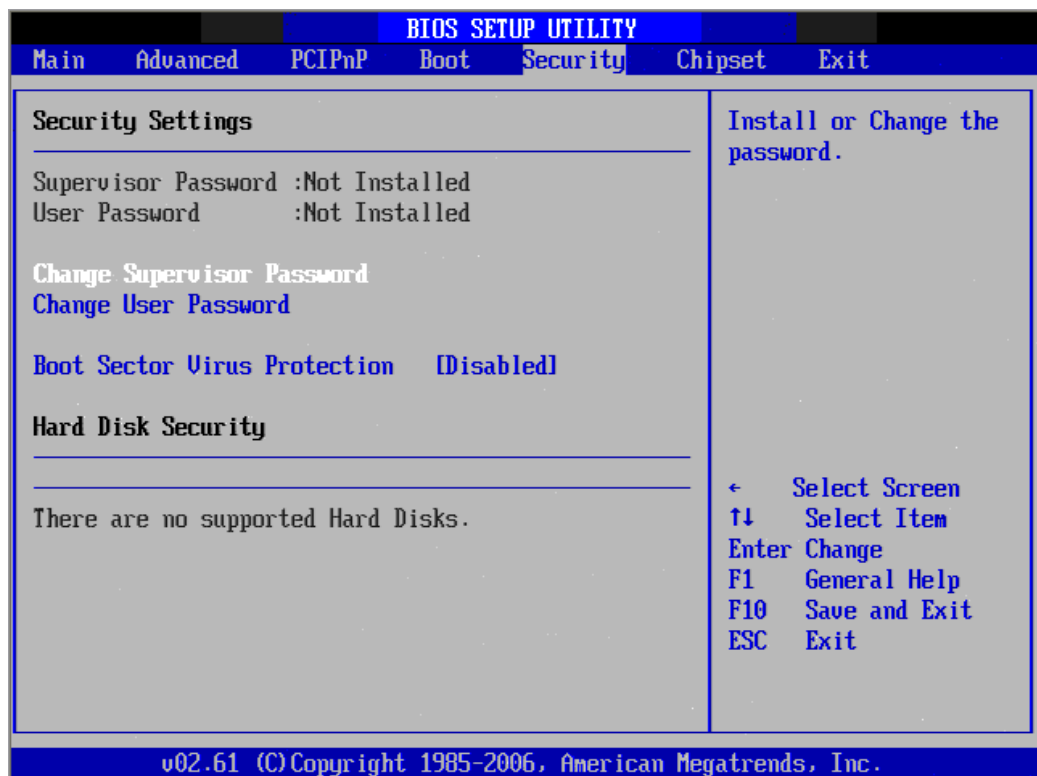

Figure 3.22 Password Configuration

Select Security Setup from the PCM-9389 Setup main BIOS setup menu. All Security Setup options, such as password protection and virus protection are described in this section. To access the sub menu for the following items, select the item and press <Enter>:

- **Change Supervisor / User Password**

- **Boot sector Virus protection**

The boot sector virus protection will warn if any program tries to write to the boot sector.

3.7 Advanced Chipset Settings



Figure 3.23 Advanced Chipset Settings

3.7.1 North Bridge Chipset Configuration



Figure 3.24 North Bridge Configuration

- **DRAM Frequency**
This item allows you to manually changed DRAM frequency.
- **Configure DRAM Timing by SPD**
This item allows you to enables or disables detect by DRAM SPD.
- **Initiate Graphic Adapter**
This item allows you to select which graphics controller to use as the primary boot device.
- **Internal Graphics Mode Select**
Select the amount of system memory used by the Internal graphics device.



Figure 3.25 Video Function Configuration

- **DVMT Mode Select**
Displays the active system memory mode.
- **DVMT/FIXED Memory**
Specify the amount of DVMT / FIXED system memory to allocate for video memory.
- **Boot Display Device**
Select boot display device at post stage.
- **Flat Panel Type**
This item allows you to select which panel resolution you want.
- **Spread Spectrum Clock**
This item allows you to enable or disable spread spectrum clock.

3.7.2 South Bridge Chipset Configuration

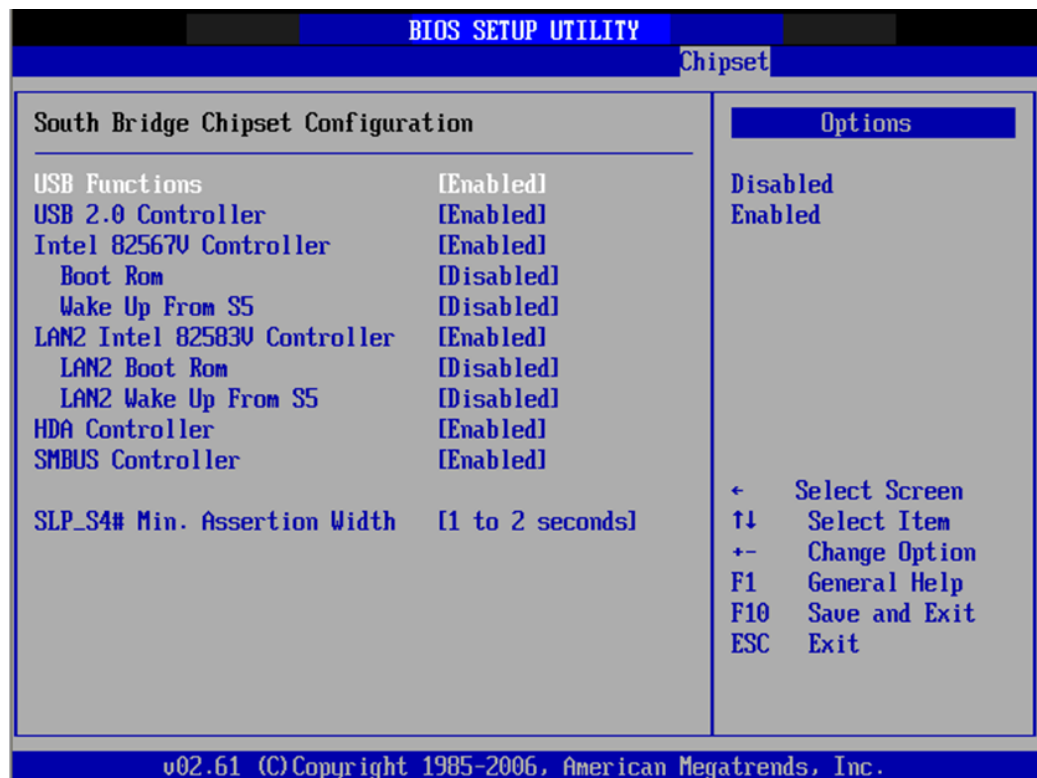

Figure 3.26 South Bridge Configuration

- **USB Functions**
Enables or disables the USB function.
- **USB 2.0 Controller**
Enables or disables the USB 2.0 controller.
- **Intel 82567V controller**
Enables or disables the LAN1 controller.
- **Boot Rom**
Enables or disables internal LAN boot.
- **Wake Up From S5**
Enables or disables LAN1 wake up from S5 function.
- **LAN2 Intel 82563V controller**
Enables or disables the LAN2 controller.
- **LAN2 Boot Rom**
Enables or disables LAN2 bootrom.
- **LAN2 Wake Up From S5**
Enables or disables LAN2 wake up from S5 function.
- **HDA Controller**
Enables or disables the HDA controller.
- **SMBUS Controller**
Enables or disables the SMBUS controller.
- **SLP_S4# Min. Assertion Width**
This item allows you to set a delay of sorts.

3.8 Exit Option

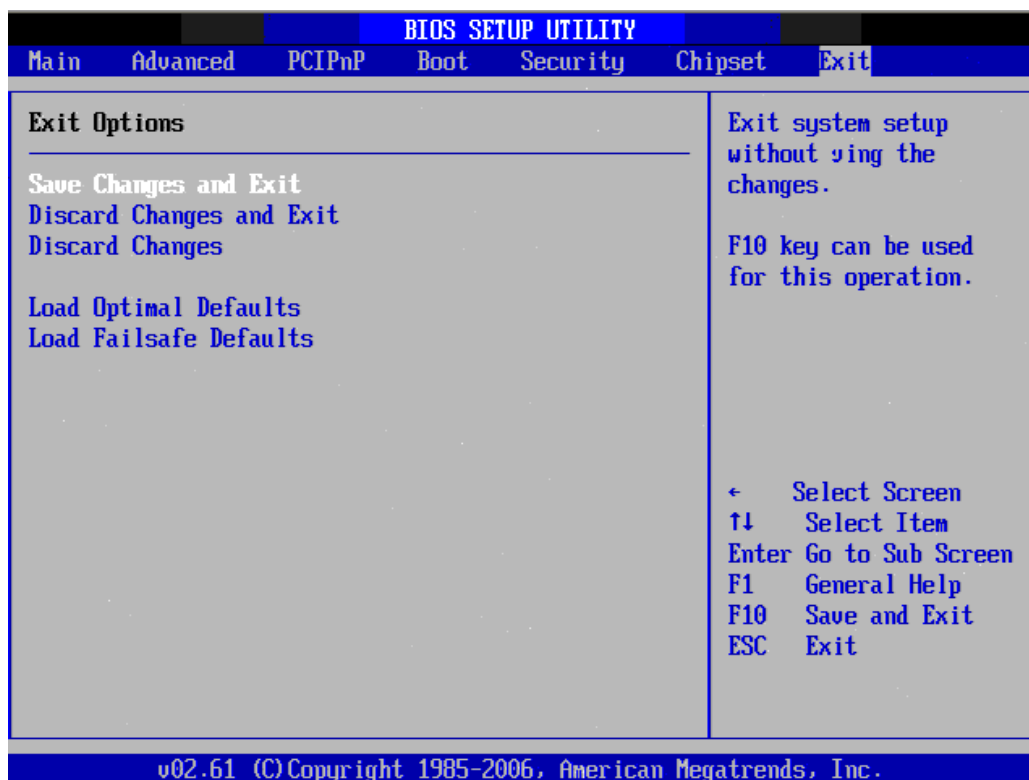

Figure 3.27 Exit Option

3.8.1 Save Changes and Exit

When you have completed system configuration, select this option to save your changes, exit BIOS setup and reboot the computer so the new system configuration parameters can take effect.

1. Select Exit Saving Changes from the Exit menu and press <Enter>. The following message appears: Save Configuration Changes and Exit Now? [Ok] [Cancel]
2. Select Ok or cancel.

3.8.2 Discard Changes and Exit

Select this option to quit Setup without making any permanent changes to the system configuration.

1. Select Exit Discarding Changes from the Exit menu and press <Enter>. The following message appears: Discard Changes and Exit Setup Now? [OK] [Cancel]
1. Select Ok to discard changes and exit. Discard Changes
2. Select Discard Changes from the Exit menu and press <Enter>.

3.8.3 Load Optimal Defaults

The PCM-9389 automatically configures all setup items to optimal settings when you select this option. Optimal Defaults are designed for maximum system performance, but may not work best for all computer applications. In particular, do not use the Optimal Defaults if your computer is experiencing system configuration problems. Select Load Optimal Defaults from the Exit menu and press <Enter>.

3.8.4 Load Fail-Safe Defaults

The PCM-9389 automatically configures all setup options to fail-safe settings when you select this option. Fail-Safe Defaults are designed for maximum system stability, but not maximum performance. Select Fail-Safe Defaults if your computer is experiencing system configuration problems.

1. Select Load Fail-Safe Defaults from the Exit menu and press <Enter>. The following message appears: Load Fail-Safe Defaults? [OK] [Cancel]
2. Select OK to load Fail-Safe defaults.

Chapter 4

S/W Introduction &
Installation

4.1 S/W Introduction

The mission of Advantech Embedded Software Services is to "Enhance quality of life with Advantech platforms and Microsoft® Windows® embedded technology." We enable Windows® embedded software products on Advantech platforms to more effectively support the embedded computing community. Customers are freed from the hassle of dealing with multiple vendors (Hardware suppliers, System integrators, Embedded OS distributor) for projects. Our goal is to make Windows embedded software solutions easily and widely available to the embedded computing community.

4.2 Driver Installation

To install the drivers please just insert the CD into CD-ROM, select the drivers that you want to install, then run the .exe (set up) file under each chipset folder and follow Driver Setup instructions to complete the installation.

4.2.1 Windows® XP Professional

To install the drivers for Windows® XP Professional, insert the CD into the CD-ROM, it will auto-detect the hardware platform and then pop up with the "Embedded Computing Install Wizard box"; just select the drivers that you want to install then click Install All Selected drivers. Follow the Driver Setup Wizard instructions; click "Next" to complete the installation.

4.2.2 Other OS

To install the drivers for another Windows® OS or Linux, please browse the CD to run the setup file under each chipset folder on the CD-ROM.

4.3 Value-Added Software Services

Software API: An interface that defines the ways by which an application program may request services from libraries and/or operating systems. Provides not only the underlying drivers required but also a rich set of user-friendly, intelligent and integrated interfaces, which speeds development, enhances security and offers add-on value for Advantech platforms. It plays the role of catalyst between developer and solution, and makes Advantech embedded platforms easier and simpler to adopt and operate with customer applications.

4.3.1 SUSI Introduction

To make hardware easier and more convenient to access for programmers, Advantech has released a suite of API (Application Programming Interface) in the form of a program library. The program Library is called Secured and Unified Smart Interface or SUSI for short.

In modern operating systems, user space applications cannot access hardware directly. Drivers are required to access hardware. User space applications access hardware through drivers. Different operating systems usually define different interface for drivers. This means that user space applications call different functions for hardware access in different operating systems. To provide a uniform interface for accessing hardware, an abstraction layer is built on top of the drivers and SUSI is such an abstraction layer. SUSI provides a uniform API for application programmers to access the hardware functions in different Operating Systems and on different Advantech hardware platforms.

Application programmers can invoke the functions exported by SUSI instead of calling the drivers directly. The benefit of using SUSI is portability. The same set of APIs is defined for different Advantech hardware platforms. Also, the same API set is implemented in different Operating Systems including Windows® XP and Windows® CE. This user's manual describes some sample programs and the API in SUSI. The hardware functions currently supported by SUSI can be grouped into a few categories including Watchdog, I²C, SMBus, GPIO, and VGA control. Each category of API in SUSI is briefly described below.

4.3.2 Software APIs

4.3.2.1 The GPIO API

General Purpose Input/Output is a flexible parallel interface that allows a variety of custom connections. It allows users to monitor the level of signal input or set the output status to switch on/off a device. Our API also provides Programmable GPIO, which allows developers to dynamically set the GPIO input or output status.

4.3.2.2 The I²C API

I²C is a bi-directional two-wire bus that was developed by Phillips for use in their televisions in the 1980s and nowadays is used in various types of embedded systems. The strict timing requirements defined in the I²C protocol has been taken care of by SUSI. Instead of asking application programmers to figure out the strict timing requirements in the I²C protocol, the I²C API in SUSI can be used to control I²C devices by invoking other function calls. SUSI provides a consistent programming interface for different Advantech boards. That means user programs using SUSI are portable among different Advantech boards as long as the boards and SUSI provide the required functionalities. Overall product development times can be greatly reduced using SUSI.

4.3.2.3 The SMBus API

The System Management Bus (SMBus) is a two-wire interface defined by Intel® Corporation in 1995. It is based on the same principles of operation of I²C and is used in personal computers and servers for low-speed system management communications. Nowadays, it can be seen in many types of embedded systems. As with other API in SUSI, the SMBus API is available on many platforms including Windows XP and Windows CE.

4.3.2.4 The Display Control API

There are two kinds of VGA control APIs, backlight on/off control and brightness control. Backlight on/off control allows a developer to turn on or off the backlight, and to control brightness smoothly.

1. Brightness Control
 - The Brightness Control API allows a developer to interface with an embedded device to easily control brightness.
2. Backlight Control
 - The Backlight API allows a developer to control the backlight (screen) on/off in an embedded device.

4.3.2.5 The Watchdog API

A watchdog timer (abbreviated as WDT) is a hardware device which triggers an action, e.g. rebooting the system, if the system does not reset the timer within a specific period of time. The WDT API in SUSI provides developers with functions such as starting the timer, resetting the timer, and setting the timeout value if the hardware requires customized timeout values.

4.3.2.6 The Hardware Monitor API

The hardware monitor (abbreviated as HWM) is a system health supervision capability achieved by placing certain I/O chips along with sensors for inspecting the target of interests for certain condition indexes, such as fan speed, temperature and voltage etc.

However, due to the inaccuracy among many commercially available hardware monitoring chips, Advantech has developed a unique scheme for hardware monitoring - achieved by using a dedicated micro-processor with algorithms specifically designed for providing accurate, real-time and reliable data content; helping protect your system in a more reliable manner.

4.3.2.7 The Power Saving API

1. CPU Speed
 - Make use of Intel SpeedStep technology to reduce power consumption. The system will automatically adjust the CPU Speed depending on system loading.
2. System Throttling
 - Refers to a series of methods for reducing power consumption in computers by lowering the clock frequency. APIs allow the user to lower the clock from 87.5% to 12.5%.

4.3.3 SUSI Utilities

4.3.3.1 BIOS Flash

The BIOS Flash utility allows customers to update the flash ROM BIOS version, or use it to back up current BIOS by copying it from the flash chip to a file on customers' disk. The BIOS Flash utility also provides a command line version and API for fast implementation into customized applications.

4.3.3.2 Embedded Security ID

The embedded application is the most important property of a system integrator. It contains valuable intellectual property, design knowledge and innovation, but it is easily copied! The Embedded Security ID utility provides reliable security functions for customers to secure their application data within embedded BIOS.

4.3.3.3 Monitoring utility

The Monitoring utility allows the customer to monitor system health, including voltage, CPU and system temperature and fan speed. These items are important to a device; if critical errors happen and are not solved immediately, permanent damage may be caused.

4.3.3.4 eSOS

The eSOS is a small OS stored in BIOS ROM. It will boot up in case of a main OS crash. It will diagnose the hardware status, and then send an e-mail to a designated administrator. The eSOS also provides remote connection: Telnet server and FTP server, allowing the administrator to rescue the system.

4.3.3.5 Flash Lock

Flash Lock is a mechanism that binds the board and CF card (SQFlash) together. The user can “Lock” SQFlash via the Flash Lock function and “Unlock” it via BIOS while booting. A locked SQFlash cannot be read by any card reader or boot from other platforms without a BIOS with the “Unlock” feature.

4.3.4 SUSI Installation

SUSI supports many different operating systems. Each subsection below describes how to install SUSI and related software on a specific operating system. Please refer to the subsection matching your operating system.

4.3.4.1 Windows® XP

In Windows® XP, you can install the library, drivers and demo programs onto the platform easily using the installation tool--The SUSI Library Installer. After the installer has executed, the SUSI Library and related files for Windows XP can be found in the target installation directory. The files are listed in the following table.

| Directory | Contents |
|-----------|---|
| \Library | <ul style="list-style-type: none"> ■ Susi.lib Library for developing the applications on Windows XP. ■ Susi.dll Dynamic library for SUSI on Windows XP. |
| \Demo | <ul style="list-style-type: none"> ■ SusiDemo.EXE Demo program on Windows XP. ■ Susi.dll Dynamic library for SUSI on Windows XP. |
| \Demo\SRC | Source code of the demo program on Windows XP. |

The following section illustrates the installation process.

Note! *The SUSI Library Installer screen shots shown below are examples only. Your screens may vary depending on your particular version.*



1. Extract Susi.zip.
2. Double-click the "Setup.exe" file.

The installer searches for a previous installation of the SUSI Library. If it locates one, a dialog box opens asking whether you want to modify, repair or remove the software. If a previous version is located, please see the [Maintenance Setup] section. If it is not located, an alternative window appears. Click Next.

4.3.4.2 Windows® CE

In Windows® CE, there are three ways to install the SUSI Library, you can install it manually or use Advantech CE-Builder to install the library or just copy the programs and the library onto a compact flash card.

Express Installation:

You can use Advantech CE-Builder to load the library into the image.

- First, you click the My Component tab.
- In this tab, you click Add New Category button to add a new category, e.g. the SUSI Library.
- Then you can add a new file in this category, and upload the SUSI.dll for this category.
- After these steps, you can select the SUSI Library category you created for every project.

Manual Installation:

You can add the SUSI Library into the image by editing any bib file.

First you open project.bib in the platform builder.

- Add this line to the MODULES section of project.bib
Susi.dll \$_FLATRELEASEDIR)\Susi.dll NK SH
- If you want to run the window-based demo, add following line:
SusiTest.exe \$_FLATRELEASEDIR)\SusiTest.exe
- If you want to run the console-based demo, add following lines:
Watchdog.exe \$_FLATRELEASEDIR)\Watchdog.exe NK S
GPIO.exe \$_FLATRELEASEDIR)\GPIO.exe NK S
SMBUS.exe \$_FLATRELEASEDIR)\SMBUS.exe NK S
- Place the three files into any files directory.
- Build your new Windows CE operating system.

4.3.5 SUSI Sample Programs

Sample Programs

The sample programs demonstrate how to incorporate SUSI into your program. There are sample programs for two categories of operating system, i.e. Windows XP and Windows CE. The sample programs run in graphics mode in Windows XP and Windows CE. The sample programs are described in the subsections below.

Windows® Graphics Mode

There are sample programs of Windows in graphics mode for two categories of operating system, i.e. Windows CE and Windows XP. Each demo application contains an executable file SusiDemo.exe, a shared library Susi.dll and source code within the release package. The files of Windows CE and Windows XP are not compatible with each other.

SusiDemo.exe is an executable file and it requires the shared library, Susi.dll, to demonstrate the SUSI functions. The source code of SusiDemo.exe also has two versions, i.e. Windows CE and Windows XP, and must be compiled under Microsoft Visual C++ 6.0 on Windows XP or under Microsoft Embedded Visual C++ 4.0 on Windows CE. Developers must add the header file Susi.h and library Susi.lib to their own projects when they want to develop something with SUSI.

SusiDemo.exe

The SusiDemo.exe test application is an application which uses all functions of the SUSI Library. It has five major function blocks: Watchdog, GPIO, SMBus, I²C and VGA control. The following screen shot appears when you execute SusiDemo.exe. You can click function tabs to select test functions respectively. Some function tabs will not show on the test application if your platform does not support such functions. For a complete support list, please refer to Appendix A. We describe the steps to test all functions of this application.



GPIO

The screenshot shows a software interface for GPIO control. It is divided into two main sections: 'GPIO INFORMATION' and 'GPIO CONTROL'.
- In the 'GPIO INFORMATION' section, there are two text input fields: 'The number of Input Pins : 4' and 'The number of Output Pins : 4'.
- The 'GPIO CONTROL' section contains two radio buttons: 'Single - Pin : 3 (Pin Number)' (which is selected) and 'Multiple-Pins : 0x0 (HEX)'.
- Below the radio buttons is a text input field for '(R/W) Result : 1'.
- At the bottom of the control section are two buttons: 'READ GPIO DATA' and 'WRITE GPIO DATA'.

When the application is executed, it will display GPIO information in the GPIO INFORMATION group box. It displays the number of input pins and output pins. You can click the radio button to choose to test either the single pin function or multiple pin functions. The GPIO pin assignments of the supported platforms are located in Appendix B.

- Test Read Single Input Pin
 - Click the radio button- Single-Pin.
 - Key in the pin number to read the value of the input pin. The Pin number starts from '0'.
 - Click the READ GPIO DATA button and the status of the GPIO pin will be displayed in (R/W) Result field.
- Test Read Multiple Input Pin
 - Click the radio button- Multiple-Pins.
 - Key in the pin number from '0x01' to '0x0F' to read the value of the input pin. The pin numbers are ordered bitwise, i.e. bit 0 stands for GPIO 0, bit 1 stands for GPIO 1, etc. For example, if you want to read pin 0, 1, and 3, the pin numbers should be '0x0B'.
 - Click READ GPIO DATA button and the statuses of the GPIO pins will be displayed in (R/W) Result field.
- Test Write Single Output Pin
 - Click the radio button- Single-Pin.
 - Key in the pin numbers you want to write. Pin numbers start from '0'.
 - Key in the value either '0' or '1' in (R/W) Result field to write the output pin you chose above step.
 - Click the WRITE GPIO DATA button to write the GPIO output pin.
- Test Write Multiple Output Pins
 - Click the radio button- Multiple-Pins.
 - Key in the pin number from '0x01' to '0x0F' to choose the multiple pin numbers to write the value of the output pin. The pin numbers are ordered bitwise, i.e. bit 0 stands for GPIO 0, bit 1 stands for GPIO 1, etc. For example, if you want to write pin 0, 1, and 3, the pin numbers should be '0x0B'.
 - Key in the value in (R/W) Result field from '0x01' to '0x0F' to write the value of the output pin. The pin numbers are ordered bitwise, i.e. bit 0 stands for GPIO 0, bit 1 stands for GPIO 1, etc. For example, if you want to set pin 0

and 1 high, 3 to low, the pin number should be '0x0B/', and then you should key in the value '0x0A' to write.

- Click the WRITE GPIO DATA button to write the GPIO output pins.

I²C

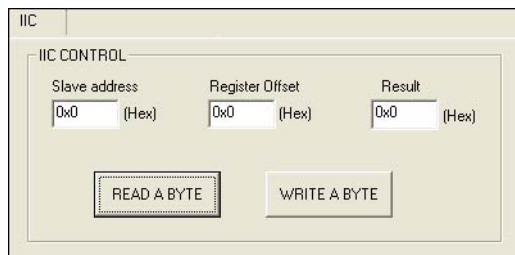

The screenshot shows a software interface titled "IIC CONTROL". It contains three input fields: "Slave address" with the value "0x0 (Hex)", "Register Offset" with the value "0x0 (Hex)", and "Result" with the value "0x0 (Hex)". Below these fields are two buttons: "READ A BYTE" and "WRITE A BYTE".

When the application is executed, you can read or write a byte of data through I²C devices. All data must be read or written in hexadecimal system.

- Read a byte
 - Key in the slave device address in Slave address field.
 - Key in the register offset in Register Offset field.
 - Click the READ A BYTE button and then a byte of data from the device will be shown on the Result field.
- Write a byte
 - Key in the slave device address in Slave address field.
 - Key in the register offset in Register Offset field.
 - Key in the desirous of data in Result field to write to the device.
 - Click the WRITE A BYTE button and then the data will be written to the device through I²C.

SMBus

The screenshot shows a software interface for SMBus operations. It is divided into two main sections: 'ACCESS MODE' and 'SMBus CONTROL'. In the 'ACCESS MODE' section, there are three radio buttons: 'Access a byte' (unselected), 'Access multiple bytes : 3 (bytes)' (selected), and 'Access a word' (unselected). The 'SMBus CONTROL' section contains two input fields: 'Slave address' with the value '0xA0 (Hex)' and 'Register Offset' with the value '0x3 (Hex)'. Below these is a 'Result (Hex)' field containing '0x4f,0x3d,0x0'. At the bottom are two buttons: 'READ SMBus DATA' and 'WRITE SMBus DATA'.

When the application has executed, you can click the radio button to choose to test each access mode, i.e. Access a byte, Access multiple bytes and Access a word. All data must be read or written in hexadecimal except the numbers for radio button: Access multiple bytes mode must be written in decimal. You can test the functionalities of the watchdog as follows:

- Read a byte
 - Click the radio button- Access a byte.
 - Key in the slave device address in the Slave address field.
 - Key in the register offset in the Register Offset field.
 - Click the READ SMBus DATA button and a byte of data from the device will be shown on the Result field.
- Write a byte
 - Click the radio button- Access a byte.
 - Key in the slave device address in Slave address field.
 - Key in the register offset in Register Offset field.
 - Key the desired data in the Result field to write to the device.
 - Click the WRITE SMBus DATA button and then the data will be written to the device through SMBus.
- Read a word
 - Click the radio button- Access a word.
 - Key in the slave device address in the Slave address field.
 - Key in the register offset in the Register Offset field.
 - Click the READ SMBus DATA button and then a word of data from the device will be shown on the Result field.
- Write a word
 - Click the radio button- Access a word.
 - Key in the slave device address in the Slave address field.
 - Key in the register offset in the Register Offset field.
 - Key in the desired data, such as 0x1234, in the Result field to write to the device.
 - Click the WRITE SMBus DATA button and the data will be written to the device through the SMBus.

- Read Multiple bytes
 - Click the radio button- Access multiple bytes.
 - Key in the slave device address in the Slave address field.
 - Key in the register offset in the Register Offset field.
 - Key in the desired number of bytes, such as 3, in the right side field of radio button- Access multiple bytes. The number must be written in decimal.
 - Click the READ SMBus DATA button and then all data from the device will be divided from each other by commas and be shown in the Result field.
- Write Multiple bytes
 - Click the radio button- Access multiple bytes.
 - Key in the slave device address in the Slave address field.
 - Key in the register offset in the Register Offset field.
 - Key in the desired number of bytes, such as 3, in the right side field of the radio button- Access multiple bytes. The number must be written in decimal.
 - Key in all the desired data in the Result field in hexadecimal format, divided by commas, for example, 0x50,0x60,0x7A.
 - Click the WRITE SMBus DATA button and all of the data will be written to the device through the SMBus.

Display Control

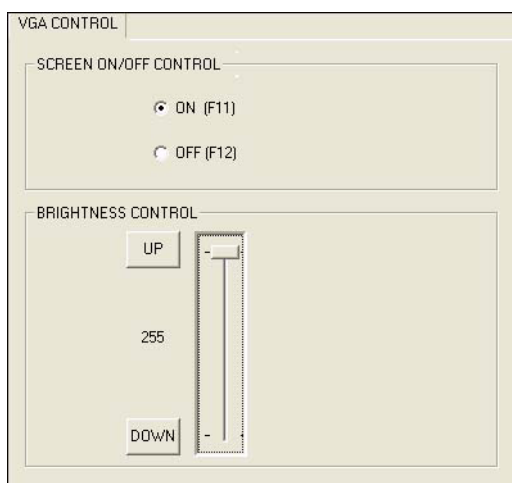

When the application is executed, it will display two blocks of VGA control functions. The application can turn on or turn off the screen shot freely, and it also can tune the brightness of the panels if your platform is being supported. You can test the functionalities of VGA control as follows:

- Screen on/off control
 - Click the radio button ON or push the key F11 to turn on the panel screen.
 - Click the radio button OFF or push the key F12 to turn off the panel screen.
 - The display chip of your platform must be in the support list in Appendix A, or this function cannot work.
- Brightness control
 - Move the slider in increments, using either the mouse or the direction keys, or click the UP button to increase the brightness.
 - Move the slider in decrements, using either the mouse or the direction keys, or click the DOWN button to decrease the brightness.

Watchdog

WATCHDOG

WATCHDOG INFORMATION

| | | |
|-------------|-------------|--------------|
| Min Timeout | Max Timeout | Timeout Setp |
| 1000 ms | 255000 ms | 1000 ms |

WATCHDOG SETTING

| | |
|-------------|---------|
| Set Delay | 2000 ms |
| Set Timeout | 3000 ms |

WATCHDOG CONTROL

Timeout Countdown

0 ms

START REFRESH STOP

When the application is executed, it will display watchdog information in the WATCHDOG INFORMATION group box. It displays max timeout, min timeout, and timeout steps in milliseconds. For example, a 1~255 seconds watchdog will have 255000 max timeout, 1000 min timeout, and 1000 timeout steps. You can test the functionality of the watchdog as follows:

- Set the timeout value 3000 (3 sec.) in the SET TIMEOUT field and set the delay value 2000 (2 sec.) in the SET DELAY field, then click the START button. The Timeout Countdown field will countdown the watchdog timer and display 5000 (5 sec.).
- Before the timer counts down to zero, you can reset the timer by clicking the REFRESH button. After you click this button, the Timeout Countdown field will display the value of the SET TIMEOUT field.
- If you want to stop the watchdog timer, just click the STOP button.

Hardware Monitor

| WATCHDOG | SMBus | IIC | MultiBytes IIC |
|-------------|---------|-------------|----------------|
| VGA CONTROL | | HWM | ABOUT |
| Voltage | | Temperature | |
| VCORE | 1.344 | CPU | 46.5 |
| V25 | 0 | SYS | 0 |
| V33 | 3.312 | Fan Speed | |
| V50 | 4.99968 | CPU | 0 |
| V120 | 11.856 | SYS | 0 |
| VSB | 4.92121 | Other | 0 |
| VBAT | 3.248 | Stop | |
| VN50 | 2.84571 | | |
| VN120 | 1.78971 | | |
| VTT | 2.528 | | |

When the Monitor application is executed by clicking the button, hardware monitoring data values will be displayed. If certain data values are not supported by the platform, the correspondent data field will be grayed-out with a value of 0.

For more details on PCM-9389 software API, please contact your dealer or Advantech AE. API user manuals are also included on this CD.

Appendix **A**

Pin Assignments

A.1 Jumper Setting

Table A.1: Jumper List

| Location | Function |
|----------|----------------------------|
| J1 | AT/ATX power supply |
| J2 | COM2 RS-232/422/485 switch |
| J3 | LCD Power |

A.2 Connectors

Table A.2: Connector List

| Location | Function |
|----------|-----------------------|
| CN1 | AT/ATX power input |
| CN3 | DDR3 SODIMM socket |
| CN7 | Power switch |
| CN8 | GPIO |
| CN9 | VGA |
| CN10 | CF socket |
| CN11 | HDD & PWR LED |
| CN12 | SATA |
| CN13 | SATA |
| CN14 | USB |
| CN15 | USB |
| CN16 | COM1: RS-232 |
| CN17 | COM2: RS-232 |
| CN18 | COM2: RS-422/485 |
| CN19 | COM3/COM4: RS-232 |
| CN20 | LPC |
| CN21 | PS/2 |
| CN22 | SMBus |
| CN23 | CPU FAN |
| CN24 | LAN1 (External) |
| CN25 | LAN2 (Internal) |
| CN26 | Audio |
| CN27 | PC/104 |
| CN28 | ISA -5V & -12V input |
| CN29 | Inverter power output |
| CN30 | LVDS |
| CN31 | TTL (by request) |

| | |
|-------------|--|
| J1 | AT/ATX power supply |
| Part Number | 1653002101 |
| Footprint | HD_2x1P_79_D |
| Description | PIN HEADER 2*1P 180D(M)SQUARE 2.0mm DIP W/O Pb |
| Setting | Function |
| NC | ATX |
| (1-2)* | AT |

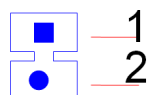

| | |
|-------------|--|
| J2 | COM2 RS-232/422/485 switch |
| Part Number | 1653003260 |
| Footprint | HD_3x2P_79 |
| Description | PIN HEADER 3x2P 2.0mm 180D(M) SMD 21N22050 |
| Setting | Function |
| (1-2)* | RS232 |
| (3-4) | RS485 |
| (5-6) | RS422 |

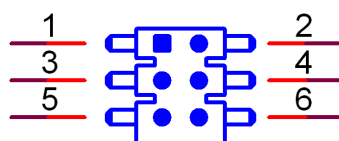

| | |
|-------------|--|
| J3 | LCD power |
| Part Number | 1653003101 |
| Footprint | HD_3x1P_79_D |
| Description | PIN HEADER 3x1P 2.0mm 180D(M) DIP 2000-13 WS |
| Setting | Function |
| (1-2) | +5V |
| (2-3)* | +3.3V |

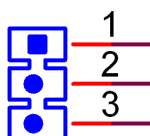

| | |
|-------------|---|
| CN1 | AT/ATX power input |
| Part Number | 1655412090 |
| Footprint | ATXCON-2X6V-42 |
| Description | POWER Conn. 6x2P 180D(M) DIP 4200-WS-A1-6*2 |
| Pin | Pin Name |
| 1 | GND |
| 2 | +5V |
| 3 | +5V |
| 4 | GND |
| 5 | +5V |
| 6 | +5V |
| 7 | GND |
| 8 | GND |
| 9 | +5VSB |
| 10 | PSON# |
| 11 | GND |
| 12 | +12V |

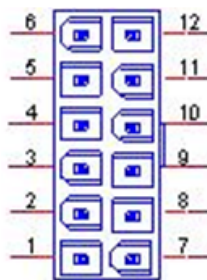

Matching cable: AT 1700016141 (Standard cable), ATX 1700001112 (Optional accessory)

| | |
|-------------|--|
| CN3 | DDR3 SODIMM socket |
| Part Number | 1651001904 |
| Footprint | DDR3_204P_2-2013289-1 |
| Description | DDR3-SODIMM H=5.2mm 204P SMD STD 2-2013289-1 |
| Pin | Pin Name |

| | |
|-------------|--|
| CN7 | Power switch |
| Part Number | 1655302020 |
| Footprint | WF_2P_79_BOX_R1_D |
| Description | WAFER BOX 2P 2.0mm 180D(M) DIP A2001WV2-2P |
| Pin | Pin Name |
| 1 | PSIN |
| 2 | GND |



| | |
|-------------|--|
| CN8 | GPIO |
| Part Number | 1653004099 |
| Footprint | HD_5x2P_79_23N685B-10M10 |
| Description | BOX HEADER 5x2P 2.00mm 180D(M) SMD 23N685B-10M10 |
| Pin | Pin Name |
| 1 | +5V |
| 2 | GPIO4 |
| 3 | GPIO0 |
| 4 | GPIO5 |
| 5 | GPIO1 |
| 6 | GPIO6 |
| 7 | GPIO2 |
| 8 | GPIO7 |
| 9 | GPIO3 |
| 10 | GND |

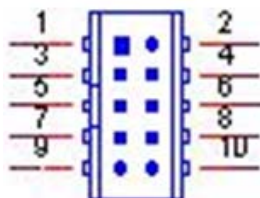

| | |
|-------------|--|
| CN9 | VGA |
| Part Number | 1654000055 |
| Footprint | DBVGA-VF5MS |
| Description | D-SUB Conn. 15P 90D(F) DIP 070242FR015S200ZU |
| Pin | Pin Name |
| 1 | RED |
| 2 | GREEN |
| 3 | BLUE |
| 4 | NC |
| 5 | GND |
| 6 | GND |
| 7 | GND |
| 8 | GND |
| 9 | NC |
| 10 | GND |
| 11 | NC |
| 12 | DDAT |
| 13 | HSYNC |
| 14 | VSYNC |
| 15 | DCLK |



| | |
|-------------|--|
| CN10 | CF socket |
| Part Number | 1653002919 |
| Footprint | CF_50P_CFCMD-35T15W100 |
| Description | CF HEADER 50P 90D(M) SMD CFCMD-35T15W100 |
| Pin | Pin Name |
| 1 | GND |
| 2 | D03 |
| 3 | D04 |
| 4 | D05 |
| 5 | D06 |
| 6 | D07 |
| 7 | CS0# |
| 8 | GND |
| 9 | GND |
| 10 | GND |
| 11 | GND |
| 12 | GND |
| 13 | +5V |
| 14 | GND |
| 15 | GND |
| 16 | GND |
| 17 | GND |
| 18 | A02 |
| 19 | A01 |
| 20 | A00 |
| 21 | D00 |
| 22 | D01 |
| 23 | D02 |
| 24 | NC |
| 25 | CD2# |
| 26 | CD1# |

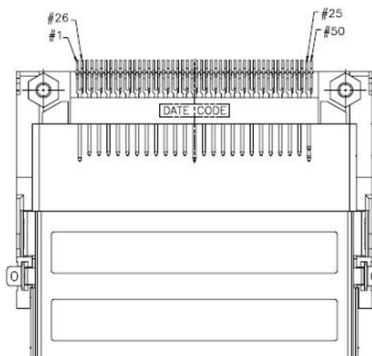

| | |
|-------------|--|
| CN11 | HDD & PWR LED |
| Part Number | 1655306020 |
| Footprint | WHL6V-2M |
| Description | WAFER BOX 6P 2.0mm 180D(M) DIP A2001WV2-6P |
| Pin | Pin Name |
| 1 | +5V |
| 2 | GND |
| 3 | Power LED+ |
| 4 | Power LED- |
| 5 | HDD LED+ |
| 6 | HDD LED- |



| | |
|-------------|--|
| CN12/CN13 | SATA |
| Part Number | 1654004659 |
| Footprint | SATA_7P_WATM-07DBN4A3B8UW_D |
| Description | Serial ATA Con 7p 180D(M)DIP 1.27mm WO/Pb(L=3.3) |
| Pin | Pin Name |
| 1 | GND |
| 2 | TX+ |
| 3 | TX- |
| 4 | GND |
| 5 | RX- |
| 6 | RX+ |
| 7 | GND |

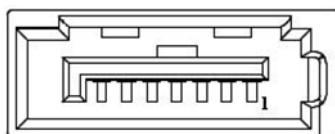

Matching cable: 1700006291

| | |
|-------------|--|
| CN14/CN15 | USB |
| Part Number | 1653005260 |
| Footprint | HD_5x2P_79_N10 |
| Description | PIN HEADER 2x5P 2.0mm 180D(M) SMD 21N22050 |
| Pin | Pin Name |
| 1 | +5V |
| 2 | +5V |
| 3 | A_D- |
| 4 | B_D- |
| 5 | A_D+ |
| 6 | B_D+ |
| 7 | GND |
| 8 | GND |
| 9 | GND |

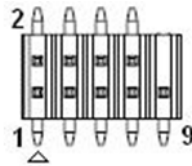

Matching cable: 1700018730

| | |
|-------------|---|
| CN16 | COM1 |
| Part Number | 1654000056 |
| Footprint | DBC0M-VM5MS |
| Description | D-SUB Conn. 9P 90D(M) DIP 070241MR009S200ZU |
| Pin | Pin Name |
| 1 | DCD# |
| 2 | RXD |
| 3 | TXD |
| 4 | DTR# |
| 5 | GND |
| 6 | DSR# |
| 7 | RTS# |
| 8 | CTS# |
| 9 | RI# |

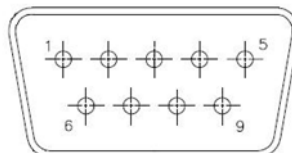

| | |
|-------------|--|
| CN17 | COM2: RS-232 |
| Part Number | 1653004099 |
| Footprint | HD_5x2P_79_23N685B-10M10 |
| Description | BOX HEADER 5x2P 2.00mm 180D(M) SMD 23N685B-10M10 |
| Pin | Pin Name |
| 1 | DCD1# |
| 2 | DSR1# |
| 3 | RXD1 |
| 4 | RTS1# |
| 5 | TXD1 |
| 6 | CTS1# |
| 7 | DTR1# |
| 8 | RI1# |
| 9 | GND |
| 10 | GND |

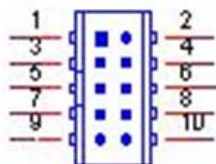

Matching cable: 1700019414

| | |
|-------------|---|
| CN18 | COM2: RS-422/485 |
| Part Number | 1655004032 |
| Footprint | WF_5P_49_BOX_85205 |
| Description | WAFER 5P 1.25mm 180D(M) SMD 85205-05701 |
| Pin | Pin Name |
| 1 | 422RX- |
| 2 | 422RX+ |
| 3 | 422/485TX+ |
| 4 | 422/485TX- |
| 5 | GND |

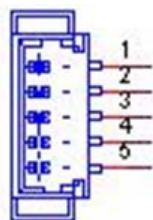

Matching cable: 1700019435

| | |
|-------------|--|
| CN19 | COM3/COM4 |
| Part Number | 1653004793 |
| Footprint | HD_10x2P_79_23N685B-20M10 |
| Description | BOX HEADER 10x2P 2.0mm 180D(M)SMD 23N685B-20M10B |
| Pin | Pin Name |
| 1 | DCD3# |
| 2 | DSR3# |
| 3 | RXD3 |
| 4 | RTS3# |
| 5 | TXD3 |
| 6 | CTS3# |
| 7 | DTR3# |
| 8 | RI3# |
| 9 | GND |
| 10 | GND |
| 11 | DCD4# |
| 12 | DSR4# |
| 13 | RXD4 |
| 14 | RTS4# |
| 15 | TXD4 |
| 16 | CTS4# |
| 17 | DTR4# |
| 18 | RI4# |
| 19 | GND |
| 20 | GND |

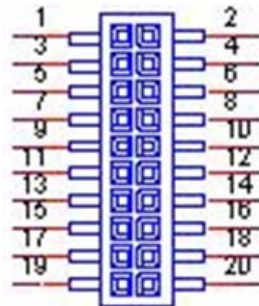

Matching cable: 1701200220

| | |
|-------------|--------------------------------------|
| CN20 | LPC |
| Part Number | 1653007270 |
| Footprint | HD_7x2P_79_F |
| Description | FEMALE HEADER SMD 7*2P 180D(F) 2.0mm |
| Pin | Pin Name |
| 1 | CLK |
| 2 | AD1 |
| 3 | RESET# |
| 4 | AD0 |
| 5 | FRAME# |
| 6 | +3.3V |
| 7 | AD3 |
| 8 | GND |
| 9 | AD2 |
| 10 | NC |
| 11 | LPC_SERIRQ |
| 12 | PWROK |
| 13 | +5V |
| 14 | +5V |

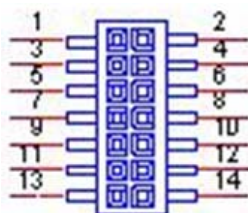

| | |
|-------------|--------------------------------------|
| CN21 | PS/2 |
| Part Number | 1654003199 |
| Footprint | CONTEK_MQN3261F1G400 |
| Description | MINI DIN 6P 90D(F) DIP MQN3261F1G400 |
| Pin | Pin Name |
| 1 | KBDAT |
| 2 | MSDAT |
| 3 | GND |
| 4 | +5V |
| 5 | KBCLK |
| 6 | MSCLK |

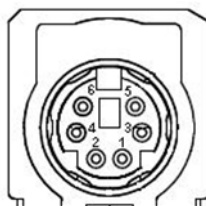

Matching cable: 1700060202

| | |
|-------------|---|
| CN22 | SMBus |
| Part Number | 1655904020 |
| Footprint | FPC4V-125M |
| Description | WAFER 4P 1.25mm 180D(M) SMD 85205-04001 |
| Pin | Pin Name |
| 1 | GND |
| 2 | SMB_DAT |
| 3 | SMB_CLK |
| 4 | +5V |

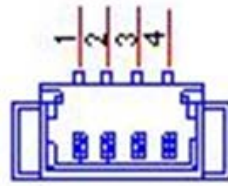

| | |
|-------------|--|
| CN23 | CPU FAN |
| Part Number | 1655303020 |
| Footprint | WHL3V-2M |
| Description | WAFER BOX 3P 2.0mm 180D(M) DIP 2001-WS-3 |
| Pin | Pin Name |
| 1 | Speed |
| 2 | +5V |
| 3 | GND |

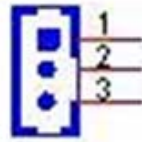

| | |
|-------------|---|
| CN24 | LAN1 (External) |
| Part Number | 1652508203 |
| Footprint | RJ45-RJM5 |
| Description | PHONE JACK RJ45 8P8C 90D SHIELDED 9743-10811-SE |
| Pin | Pin Name |
| 1 | BI_DA+(GHz) |
| 2 | BI_DA-(GHz) |
| 3 | BI_DB+(GHz) |
| 4 | BI_DC+(GHz) |
| 5 | BI_DC-(GHz) |
| 6 | BI_DB-(GHz) |
| 7 | BI_DD+(GHz) |
| 8 | BI_DD-(GHz) |

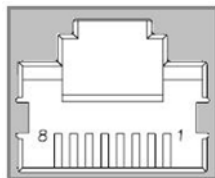

| | |
|-------------|--|
| CN25 | LAN2 (Internal) |
| Part Number | 1653004099 |
| Footprint | HD_5x2P_79_23N685B-10M10 |
| Description | BOX HEADER 5x2P 2.00mm 180D(M) SMD 23N685B-10M10 |
| Pin | Pin Name |
| 1 | GND |
| 2 | GND |
| 3 | BI_DD+(GHz) |
| 4 | BI_DD-(GHz) |
| 5 | BI_DC+(GHz) |
| 6 | BI_DC-(GHz) |
| 7 | RX+(10/100),BI_DB+(GHz) |
| 8 | RX-(10/100),BI_DB-(GHz) |
| 9 | TX+(10/100),BI_DA+(GHz) |
| 10 | TX-(10/100),BI_DA-(GHz) |

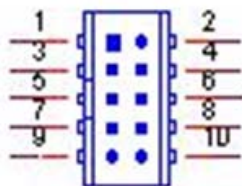

Matching cable: 1700017863

| | |
|-------------|--|
| CN26 | Audio |
| Part Number | 1653004099 |
| Footprint | HD_5x2P_79_23N685B-10M10 |
| Description | BOX HEADER 5x2P 2.00mm 180D(M) SMD 23N685B-10M10 |
| Pin | Pin Name |
| 1 | LOUTR |
| 2 | LINR |
| 3 | GND |
| 4 | GND |
| 5 | LOUTL |
| 6 | LINL |
| 7 | GND |
| 8 | GND |
| 9 | MIC1R |
| 10 | MIC1L |

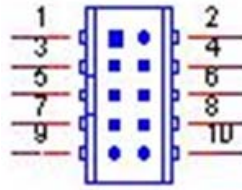

Matching cable: 1700019584

| | |
|-------------|-----------------------|
| CN27 | PC/104 |
| Part Number | 165313222A 165312022A |
| Footprint | PC104A |
| Description | |
| Pin | Pin Name |
| A1 | IOCHCK# |
| A2 | SD7 |
| A3 | SD6 |
| A4 | SD5 |
| A5 | SD4 |
| A6 | SD3 |
| A7 | SD2 |
| A8 | SD1 |
| A9 | SD0 |
| A10 | IOCHRDY# |
| A11 | AEN |
| A12 | SA19 |
| A13 | SA18 |
| A14 | SA17 |
| A15 | SA16 |
| A16 | SA15 |
| A17 | SA14 |
| A18 | SA13 |
| A19 | SA12 |
| A20 | SA11 |
| A21 | SA10 |
| A22 | SA9 |
| A23 | SA8 |
| A24 | SA7 |
| A25 | SA6 |
| A26 | SA5 |
| A27 | SA4 |
| A28 | SA3 |
| A29 | SA2 |
| A30 | SA1 |
| A31 | SA0 |
| A32 | GND |
| B1 | GND |
| B2 | RSTDRV |
| B3 | +5V |

| | |
|-----|----------|
| B4 | IRQ9 |
| B5 | -5V |
| B6 | DRQ2 |
| B7 | -12V |
| B8 | 0WS# |
| B9 | +12V |
| B10 | GND |
| B11 | SMEMW# |
| B12 | SMEMR# |
| B13 | IOW# |
| B14 | IOR# |
| B15 | DACK3# |
| B16 | DRQ3 |
| B17 | DACK1# |
| B18 | DRQ1 |
| B19 | REFRESH# |
| B20 | SYSCLK |
| B21 | IRQ7 |
| B22 | IRQ6 |
| B23 | IRQ5 |
| B24 | IRQ4 |
| B25 | IRQ3 |
| B26 | DACK2# |
| B27 | TC |
| B28 | ALE# |
| B29 | +5V |
| B30 | OSC |
| B31 | GND |
| B32 | GND |
| C1 | GND |
| C2 | SBHE# |
| C3 | LA23 |
| C4 | LA22 |
| C5 | LA21 |
| C6 | LA20 |
| C7 | LA19 |
| C8 | LA18 |
| C9 | LA17 |
| C10 | MEMR# |
| C11 | MEMW# |
| C12 | SD8 |
| C13 | SD9 |
| C14 | SD10 |
| C15 | SD11 |
| C16 | SD12 |
| C17 | SD13 |
| C18 | SD14 |
| C19 | SD15 |

| | |
|-----|----------|
| C20 | NC |
| D1 | GND |
| D2 | MEMCS16# |
| D3 | IOCS16# |
| D4 | IRQ10 |
| D5 | IRQ11 |
| D6 | IRQ12 |
| D7 | IRQ15 |
| D8 | IRQ14 |
| D9 | DACK0# |
| D10 | DRQ0 |
| D11 | DACK5# |
| D12 | DRQ5 |
| D13 | DACK6# |
| D14 | DRQ6 |
| D15 | DACK7# |
| D16 | DRQ7 |
| D17 | +5V |
| D18 | MASTER# |
| D19 | GND |
| D20 | GND |

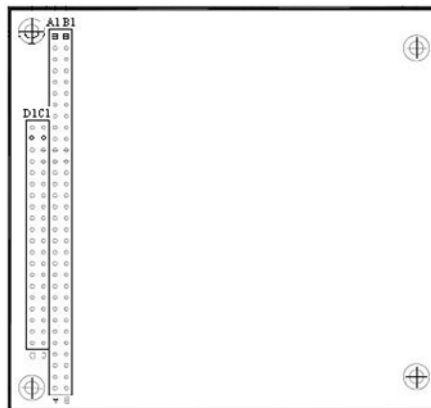

| | |
|-------------|--|
| CN28 | ISA -5V & -12V input |
| Part Number | 1653003101 |
| Footprint | HD_3x1P_79_D |
| Description | PIN HEADER 3x1P 2.0mm 180D(M) DIP 2000-13 WS |
| Pin | Pin Name |
| 1 | -5V |
| 2 | GND |
| 3 | -12V |

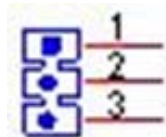

| | |
|-------------|--|
| CN29 | Inverter power output |
| Part Number | 1655000453 |
| Footprint | WHL5V-2M-24W1140 |
| Description | WAFER BOX 2.0mm 5P 180D(M) DIP WO/Pb JIH VEI |
| Pin | Pin Name |
| 1 | +12V |
| 2 | GND |
| 3 | ENABKL |
| 4 | VBR |
| 5 | +5V |

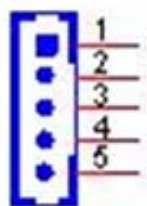

| | |
|-------------|--|
| CN30 | LVDS |
| Part Number | 1653910261 |
| Footprint | SPH10X2 |
| Description | B/B Conn 10x2P 1.25mm 180D(M)SMD DF13-20DP-1.25V |
| Pin | Pin Name |
| 1 | GND |
| 2 | GND |
| 3 | LVDS0_D0+ |
| 4 | NC |
| 5 | LVDS0_D0- |
| 6 | NC |
| 7 | LVDS0_D1+ |
| 8 | NC |
| 9 | LVDS0_D1- |
| 10 | NC |
| 11 | LVDS0_D2+ |
| 12 | NC |
| 13 | LVDS0_D2- |
| 14 | NC |
| 15 | LVDS0_CLK+ |
| 16 | LVDS0_D3+ |
| 17 | LVDS0_CLK- |
| 18 | LVDS0_D3- |
| 19 | +5V or +3.3V |
| 20 | +5V or +3.3V |

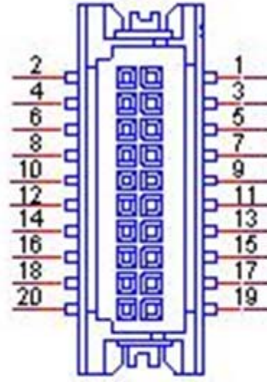

| | |
|-------------|--|
| CN31 | TTL (by request) |
| Part Number | 1653920200 |
| Footprint | SPH20X2 |
| Description | B/B Conn. 40P 1.25mm 90D SMD DF13-40DP-1.25V(91) |
| Pin | Pin Name |
| 1 | +5V |
| 2 | +5V |
| 3 | GND |
| 4 | GND |
| 5 | +3.3V |
| 6 | +3.3V |
| 7 | NC |
| 8 | GND |
| 9 | NC |
| 10 | NC |
| 11 | PD2 |
| 12 | PD3 |
| 13 | PD4 |
| 14 | PD5 |
| 15 | PD6 |
| 16 | PD7 |
| 17 | NC |
| 18 | NC |
| 19 | PD10 |
| 20 | PD11 |
| 21 | PD12 |
| 22 | PD13 |
| 23 | PD14 |
| 24 | PD15 |
| 25 | NC |
| 26 | NC |

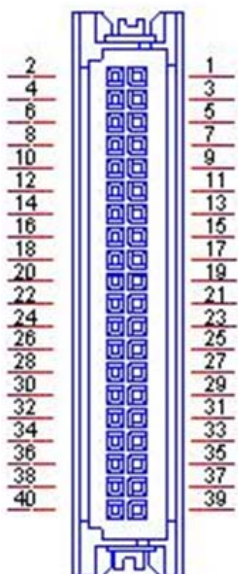

Appendix **B**

System Assignments

B.1 System I/O Ports

Table B.1: System I/O Ports

| Addr. Range (Hex) | Device |
|-------------------|--|
| 000-01F | DMA Controller |
| 020-02D | Interrupt Controller |
| 050-052 | Timer/Counter |
| 060-06F | 8042 (keyboard controller) |
| 070-07F | Real-time clock, non-maskable interrupt (NMI) mask |
| 080-09F | DMA page register |
| 0A0-0BF | 0A0-0BF |
| 0C0-0DF | DMA controller |
| 170-177 | IDE Controller |
| 1F0-1F7 | IDE Controller |
| 299-29F | Motherboard resource |
| 2E8-2EF | Serial port 4 |
| 2F8-2FF | Serial port 2 |
| 3C0-3DF | Motherboard resource |
| 3E8-3EF | Serial port 3 |
| 3F8-3FF | Serial port 1 |
| 400-4FF | Motherboard resource |
| 500-53F | Motherboard resource |
| 800-87F | Motherboard resource |

B.2 1st MB Memory Map

Table B.2: 1st MB Memory Map

| Addr. Range (Hex) | Device |
|-------------------|------------------------------------|
| F0000h - FFFFFh | System ROM |
| D0000h - EFFFFh | Unused (reserved for Ethernet ROM) |
| C0000h - CE7FFh | Expansion ROM (for VGA BIOS) |
| B8000h - BFFFFh | CGA/EGA/VGA text |
| B0000h - B7FFFh | Unused |
| A0000h - AFFFFh | EGA/VGA graphics |
| 00000h - 9FFFFh | Base memory |

B.3 DMA Channel Assignments

Table B.3: DMA Channel Assignments

| Channel | Function |
|---------|------------------------------|
| 0 | Available |
| 1 | Reserved (audio) |
| 2 | Floppy disk (8-bit transfer) |
| 3 | Available (parallel port) |
| 4 | Cascade for DMA controller 1 |
| 5 | Available |
| 6 | Available |
| 7 | Available |

* Audio DMA select 1, 3, or 5
 ** Parallel port DMA select 1 (LPT2) or 3 (LPT1)

B.4 Interrupt Assignments

Table B.4: Interrupt Assignments

| Interrupt# | Interrupt source |
|------------|---|
| IRQ0 | Interval timer |
| IRQ1 | Standard 101/102-Key or Microsoft Natural PS/2 Keyboard |
| IRQ2 | Interrupt from controller 2 (cascade) |
| IRQ3 | COM2 |
| IRQ4 | COM1 |
| IRQ5 | Available (EC Watchdog) |
| IRQ6 | Available |
| IRQ7 | Available |
| IRQ8 | System CMOS/real time clock |
| IRQ9 | Microsoft ACPI-Compliant System |
| IRQ10 | COM3 |
| IRQ11 | COM4 |
| IRQ12 | PS/2 compatible mouse |
| IRQ13 | Numeric data processor |
| IRQ14 | Primary IDE |
| IRQ15 | Secondary IDE |

ADVANTECH

Enabling an Intelligent Planet

www.advantech.com

Please verify specifications before quoting. This guide is intended for reference purposes only.

All product specifications are subject to change without notice.

No part of this publication may be reproduced in any form or by any means, electronic, photocopying, recording or otherwise, without prior written permission of the publisher.

All brand and product names are trademarks or registered trademarks of their respective companies.

© Advantech Co., Ltd. 2012