

CMF23V-104700

Description:

The CMF23 Series provides exceptional common-mode suppression and exceptional stray inductance to suppress differential-mode noise. In effect, the CMF23 Series combines the features of two separate components into one.

Construction:

Constructed with UL rated 130°C (Class B) materials.

Electrical Specifications (@20°C) @ 10kHz

Inductance(1)	L _{stray typ}	Amps(2) (A)	Max. DC (Ω) Resistance
100mH	2100uH	0.70	1.99

1. Inductance Tolerance: -30/+50%
2. Inductance per winding.
3. Operating Temperature: -40 – 105°C
4. Storage Temperature: -25°C – +40°C, ≤ 75% RH
5. Rated Voltage: 300VAC (50/60Hz)
6. Weight: 18g

CMF23 Series – Frequency Response Curve

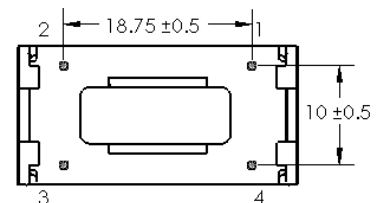
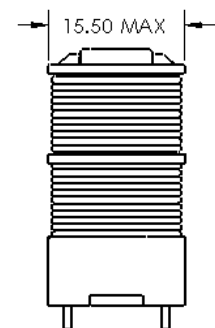
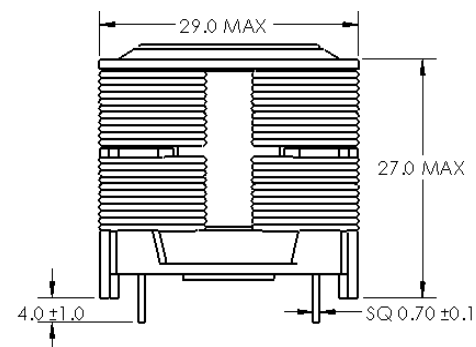
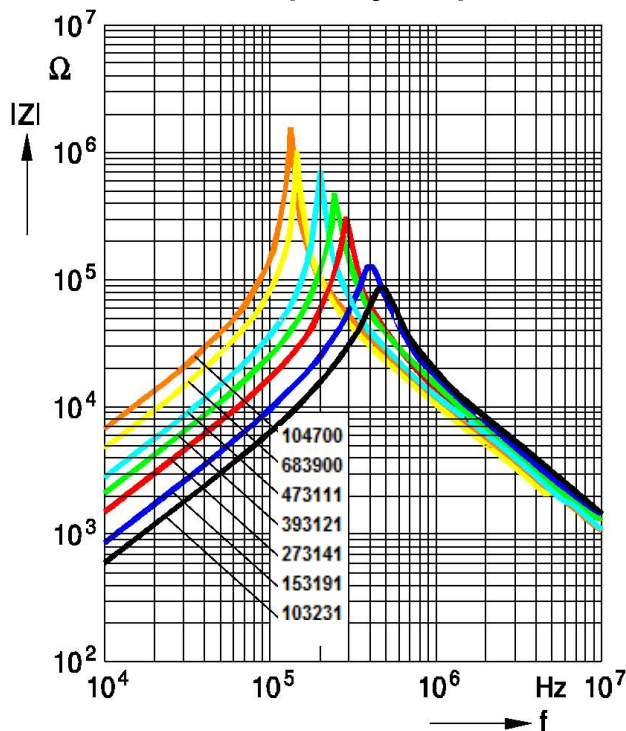

Safety: 2000VAC Dielectric Strength between windings.

RoHS Compliance: As of manufacturing date February 2005, all standard products meet the requirements of 2011/65/EU, known as the RoHS initiative.

*Upon printing, this document is considered "uncontrolled". Please contact Triad Magnetics website for the most current version. For soldering and washing information please see <http://www.triadmagnetics.com>