

KS Single Pole Key Switches



Features/Benefits

- **Positive tactile feel**
- **Variety of cap colors**
- **LED support available**
- **SPST and SPDT configurations**

Typical Applications

- **Telecommunications**
- **Industrial**
- **Instrumentation**

Specifications

CONTACT RATING: Q contact material: 25mA @ 50V AC .or DC max.
 ELECTRICAL LIFE: 100,000 actuations.
 CONTACT RESISTANCE: Below 100 mΩ initial @ 2-4 V DC, 100 mA
 INSULATION RESISTANCE: 10⁹ Ω min.
 DIELECTRIC STRENGTH: 1,000 Vrms min. @ sea level.
 OPERATING TEMPERATURE: -30°C to 65°C.
 SOLDERABILITY: Per MIL-STD-202F method 208D, or EIA RS-186E method 9 (1 hour steam aging).

Materials

CASE: Glass filled nylon (UL 94V-0).
 ACTUATOR: ABS or polycarbonate-ABS blend, matte finish, black standard.
 MOVABLE CONTACT: Q contact material: beryllium copper or stainless steel, silver plated.
 STATIONARY CONTACTS AND TERMINALS: Q contact material: copper alloy, silver plated.
 TERMINAL SEAL: Epoxy

NOTE: Specifications and materials listed above are for switches with standard options.
 For information on specific and custom switches, consult Customer Service Center.

How To Order

Our easy build-a-switch concept allows you to mix and match options to create the switch you need. To order, select desired option from each category and place it in the appropriate box.

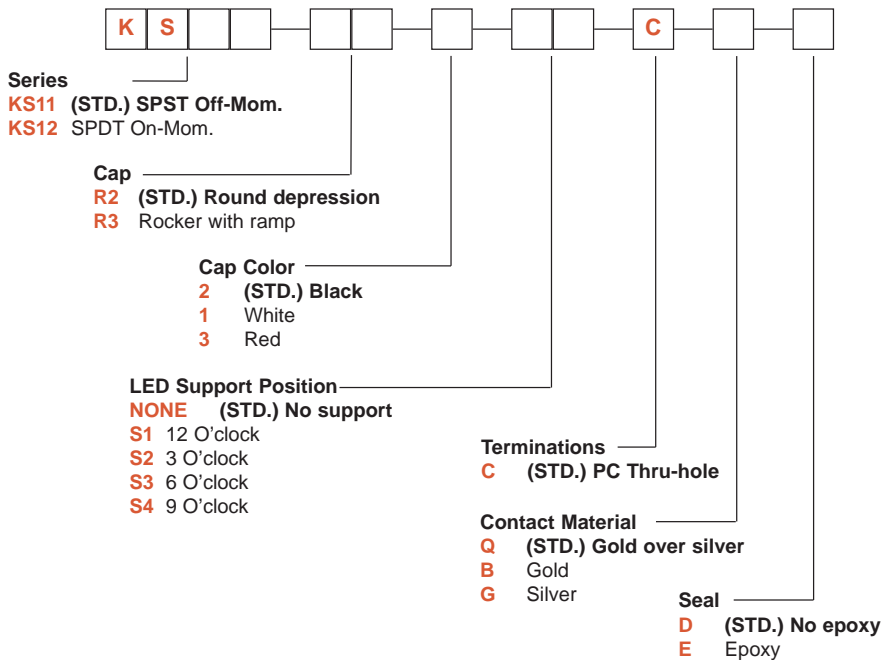

D

Key Switches

KS Single Pole Key Switches

SERIES



KS12

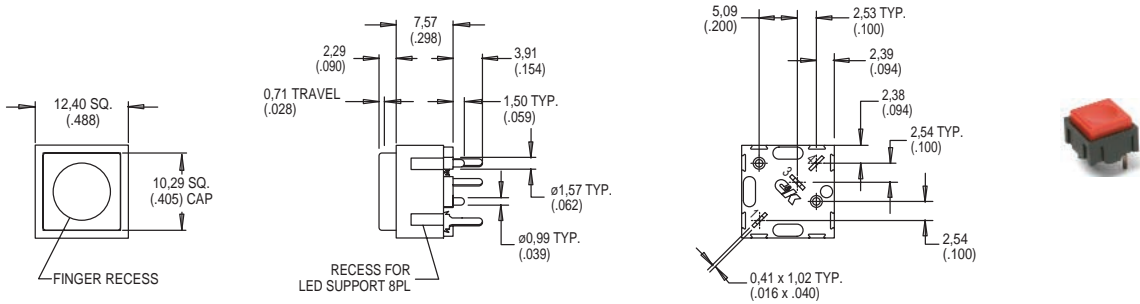

CAP



R2 (STD.) CAP WITH ROUND DEPRESSION

R3 ROCKER CAP WITH RAMP

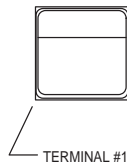
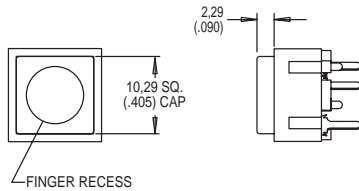

OPTION CODE	CAP COLOR
2	(STD.) BLACK
1	WHITE
3	RED

LED SUPPORT



(NONE) (STD.) NO LED SUPPORT

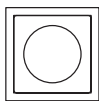

No LED support.

S1, S2, S3, S4 WITH LED SUPPORT

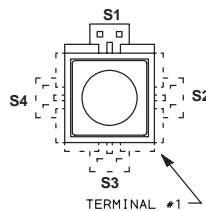

Position of factory installed LED support.

TYPICAL INSTALLATION

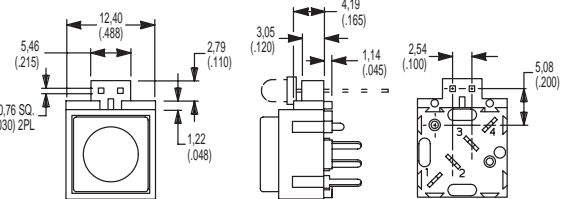

NOTE: LED support shown in position S1. LED not supplied. LED support also available separately, see page .

TERMINATION



C (STD.) PC THRU-HOLE

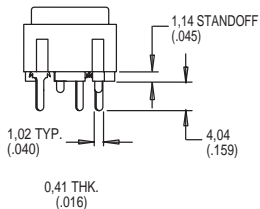

PC MOUNTING

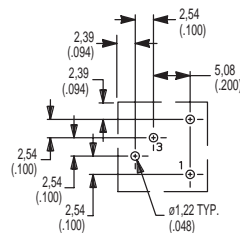

KS11

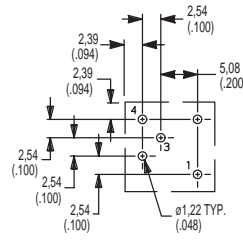

KS12

MULTIPLE SWITCH SPACING

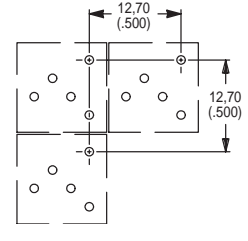

Third Angle Projection

KS Single Pole Key Switches

CONTACT MATERIAL

OPTION CODE	CONTACT MATERIAL	TERMINAL PLATING	RATINGS	
Q (STD.)	SILVER ²	SILVER ²	POWER	25 mA MAX. @ 50 V AC OR DC MAX.
B	GOLD ¹	GOLD ¹	LOW LEVEL/DRY CIRCUIT	0.4 VA MAX. @ 20 V AC OR DC MAX.
G	GOLD/SILVER ³	GOLD ¹	LOW LEVEL/DRY CIRCUIT OR POWER	0.4 VA MAX. @ 20 V AC OR DC MAX. OR 25 mA MAX. @ 50 V AC OR DC MAX.

CONTACT MATERIAL / APPLICATION RECOMMENDATIONS - SEE CHART, PAGE

¹ MOVABLE CONTACT: Beryllium copper, with gold plate over nickel plate.
STATIONARY CONTACTS & ALL TERMINALS: Copper alloy, with gold plate over nickel plate.

² MOVABLE CONTACT: Beryllium copper, silver plated.
STATIONARY CONTACTS & ALL TERMINALS: Copper alloy, silver plated.

³ MOVABLE CONTACT: Beryllium copper, with gold plate over nickel plate over silver plate.
STATIONARY CONTACTS & ALL TERMINALS: Copper alloy, with gold plate over nickel plate over silver plate.

SEAL

D (STD.) NO EPOXY SEAL

E EPOXY SEAL

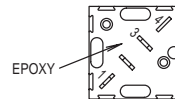

D

Key Switches