

THIS DRAWING IS UNPUBLISHED. RELEASED FOR PUBLICATION
 © COPYRIGHT - By - ALL RIGHTS RESERVED.

LOC		DIST		REVISIONS			
P	LTR	DESCRIPTION		DATE	DWN	APVD	
FT	0	A4	REVISED PER ECO-12-016943	02NOV12	KH	MB	

MATERIALS:
 HOUSING: PA66, UL94V-0, SEE TABLE.
 SCREWS; M2.5, STEEL, ZINC CHROMATE.
 CAGE: BRASS, NICKEL PLATE.
 CLAMP: PHOS BRONZE, NICKEL PLATE.

MECHANICAL:
 TIGHTENING TORQUE: 3.5 IN-LB MAX.

ELECTRICAL:
 CURRENT: 15A
 VOLTAGE: 300V
 WITHSTAND VOLTAGE: AC1500V/ 1MIN
 INSULATION RESISTANCE: 5000Mohm/1000V
 CLAMP RESISTANCE: 20mohm
 WIRE RANGE: 12-28 AWG

ENVIRONMENTAL:
 OPERATING TEMP.: -40° TO +105°C
 MAX SOLDERING: +250°C, 5 SECONDS

- 1 MARKED WITH WHITE PERMANENT INK.
- 2 PRELIMINARY PART NUMBER.

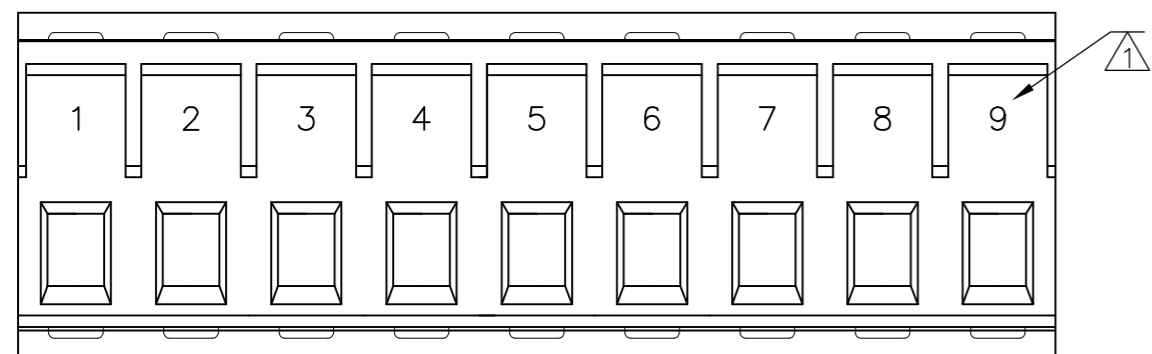
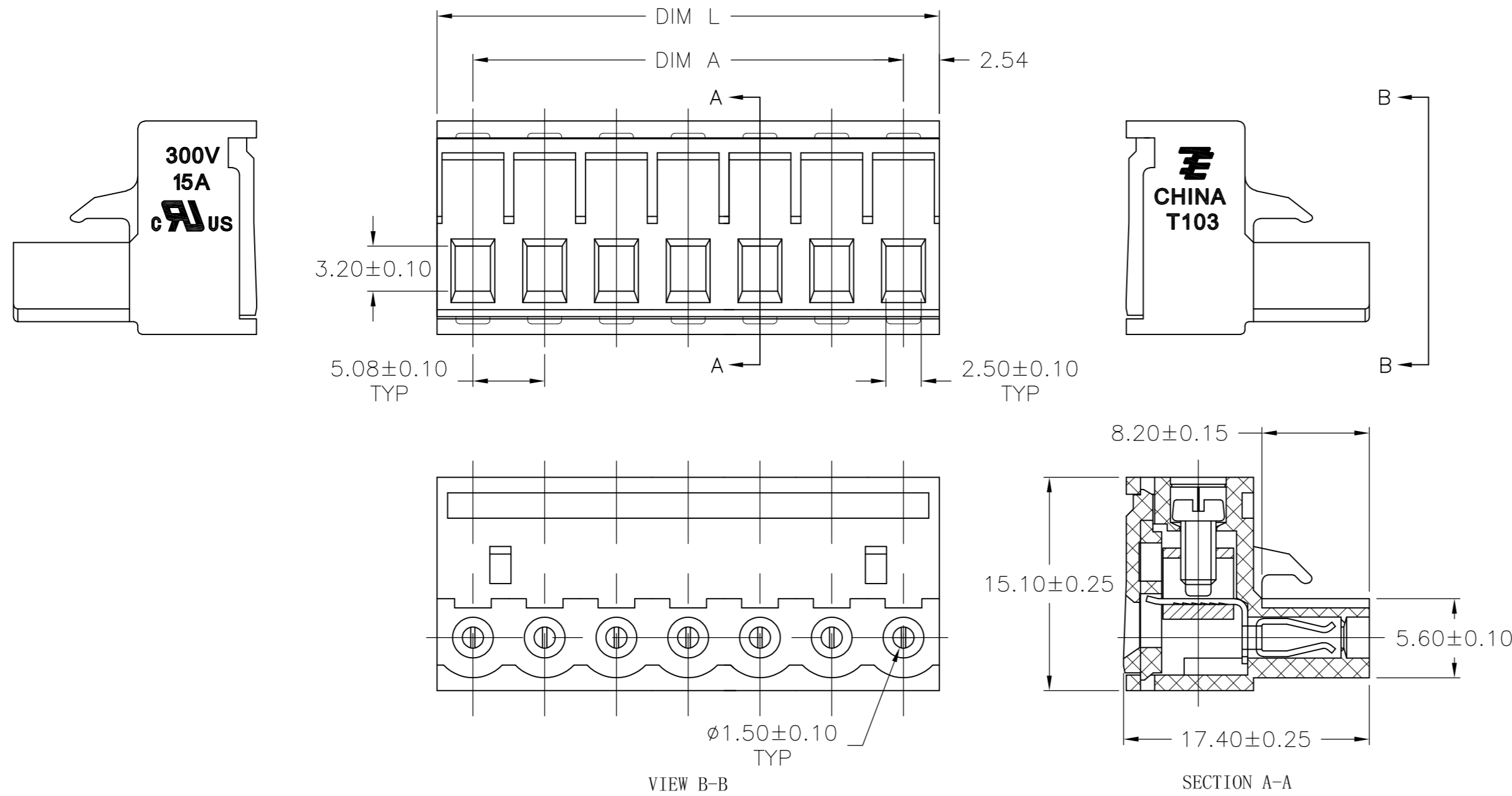

3-1776910-9

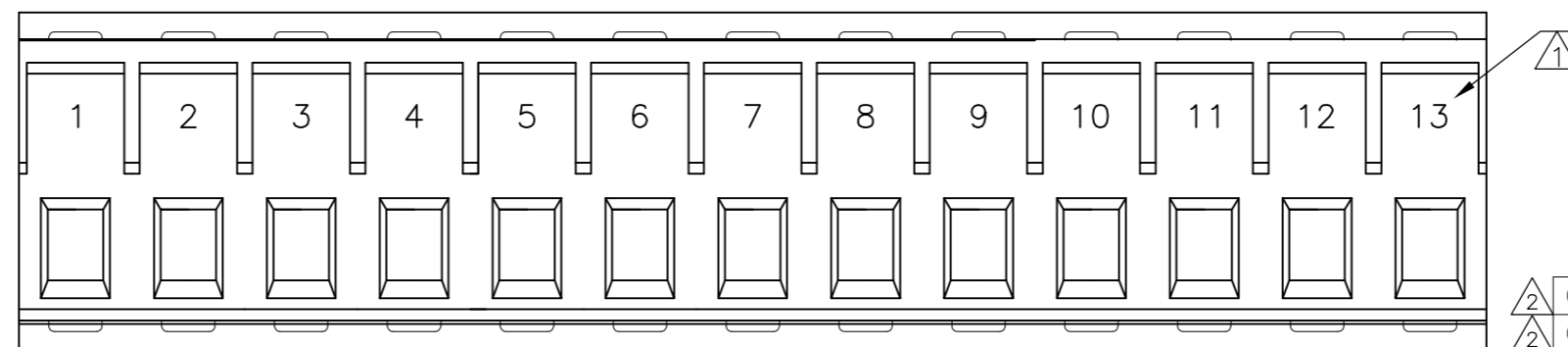

4-1776910-3

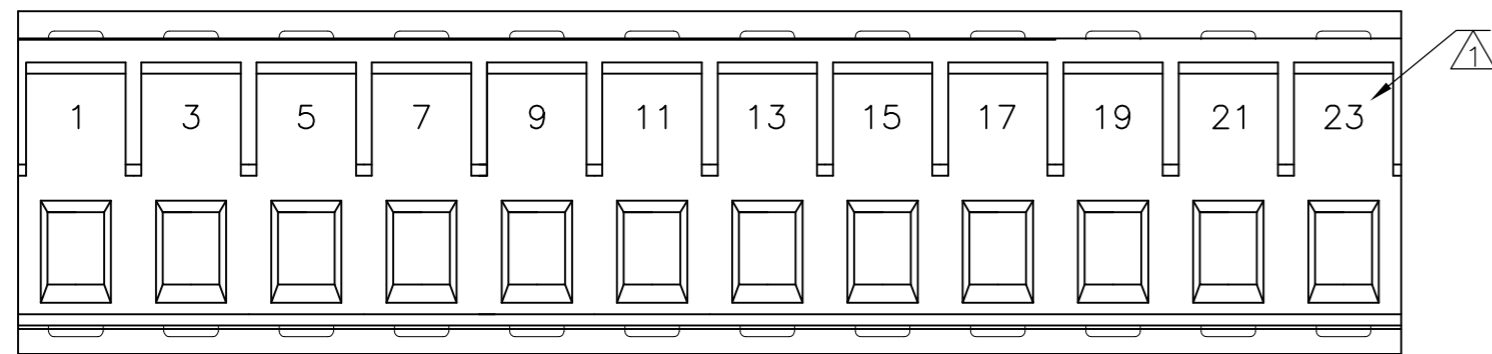

5-1776910-1

COLOR	NOTES	DIM L	DIM A	NO OF POSN	PART NUMBER
2 GREEN	SEE FIGURE	60.96±0.30	55.88±0.30	12	6-1776910-0
2 GREEN	SEE FIGURE	60.96±0.30	55.88±0.30	12	5-1776910-9
2 GREEN	SEE FIGURE	60.96±0.30	55.88±0.30	12	5-1776910-8
2 GREEN	SEE FIGURE	60.96±0.30	55.88±0.30	12	5-1776910-7
2 GREEN	SEE FIGURE	60.96±0.30	55.88±0.30	12	5-1776910-6
2 GREEN	SEE FIGURE	60.96±0.30	55.88±0.30	12	5-1776910-5
2 GREEN	SEE FIGURE	60.96±0.30	55.88±0.30	12	5-1776910-4
2 GREEN	SEE FIGURE	60.96±0.30	55.88±0.30	12	5-1776910-3
2 GREEN	SEE FIGURE	60.96±0.30	55.88±0.30	12	5-1776910-2
2 GREEN	SEE FIGURE	60.96±0.30	55.88±0.30	12	5-1776910-1
2 BLACK	SEE FIGURE	66.04±0.30	60.96±0.30	13	4-1776910-3
OBSOLETE	BLACK SEE FIGURE	45.72±0.30	40.64±0.30	9	3-1776910-9
2 BLACK	-	20.32±0.20	15.24±0.20	4	1776910-4
2 BLACK	-	15.24±0.20	10.16±0.20	3	1776910-3
2 BLACK	-	10.16±0.20	5.08±0.15	2	1776910-2

THIS DRAWING IS A CONTROLLED DOCUMENT. DWN S SCHLEGEL 01MAR2007
 CHK C RICHARD 3/1/07
 APVD C RICHARD 3/1/07
 PRODUCT SPEC
 APPLICATION SPEC

TE TE Connectivity

NAME: TERMINAL BLOCK, R/A PLUG, 5.08mm

SIZE: A2 CAGE CODE: 00779 DRAWING NO: C=1776910 RESTRICTED TO: -
 WEIGHT: - SCALE: NTS SHEET: 1 OF 2 REV: A4
 CUSTOMER DRAWING

THIS DRAWING IS UNPUBLISHED. RELEASED FOR PUBLICATION
 © COPYRIGHT - By - ALL RIGHTS RESERVED.

LOC		DIST		REVISIONS					
FT		0		P	LTR	DESCRIPTION	DATE	DWN	APVD
				-	-	SEE SHEET 1	-	-	-

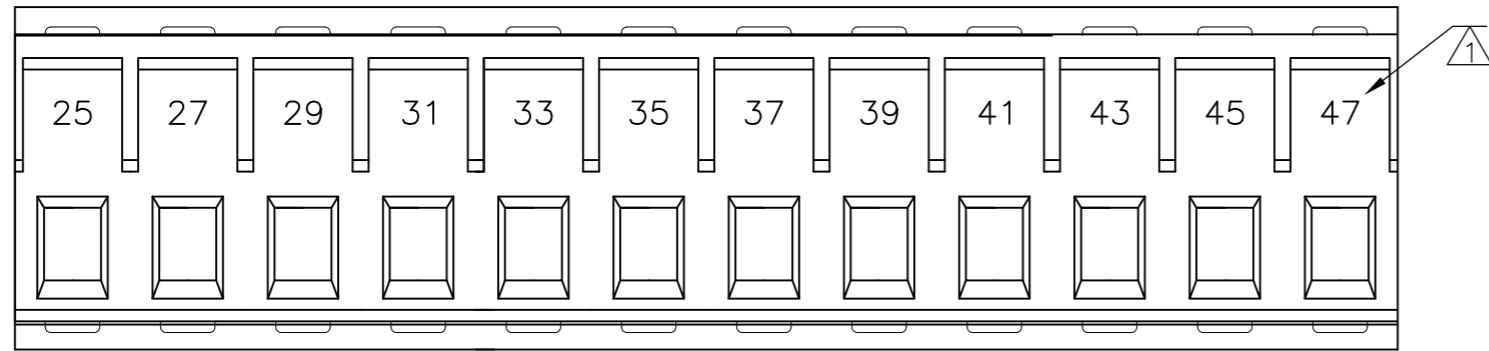

5-1776910-2

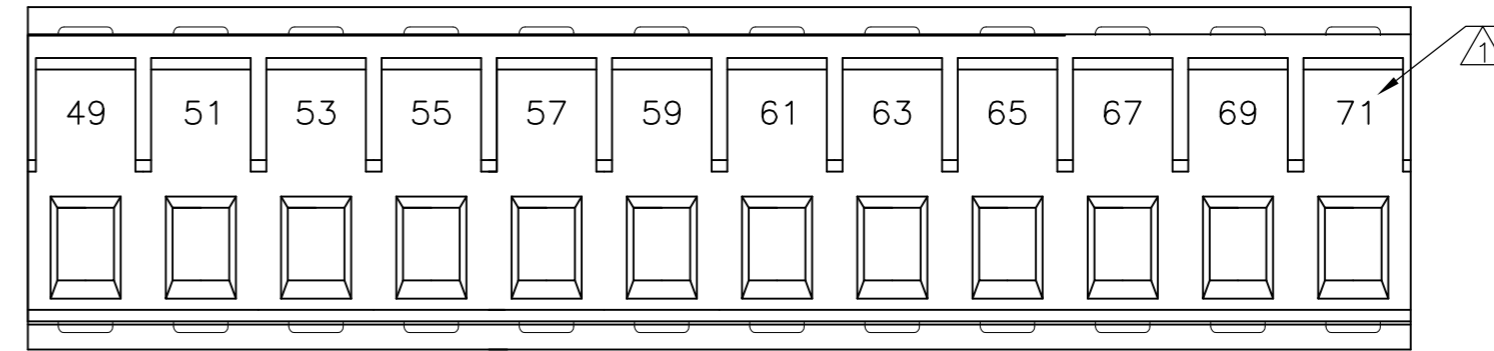

5-1776910-3

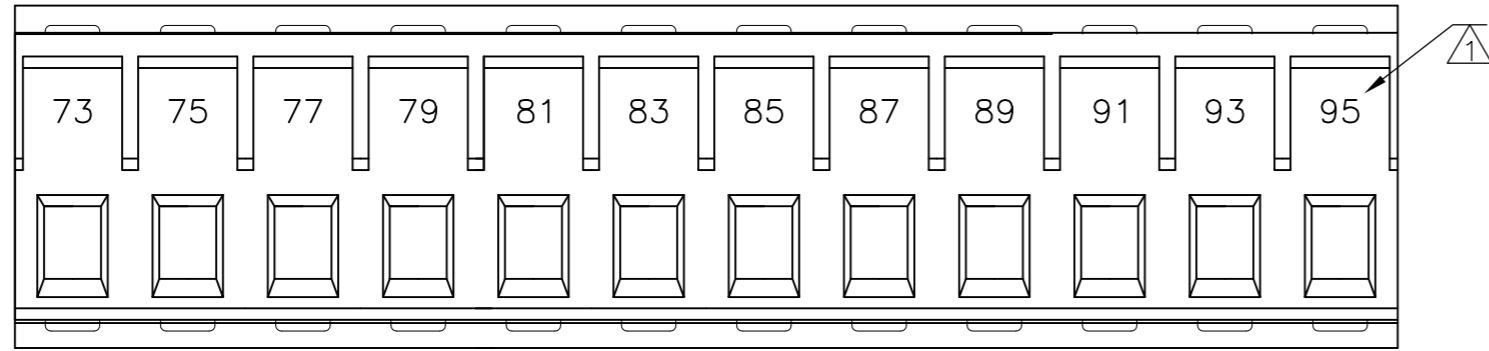

5-1776910-4

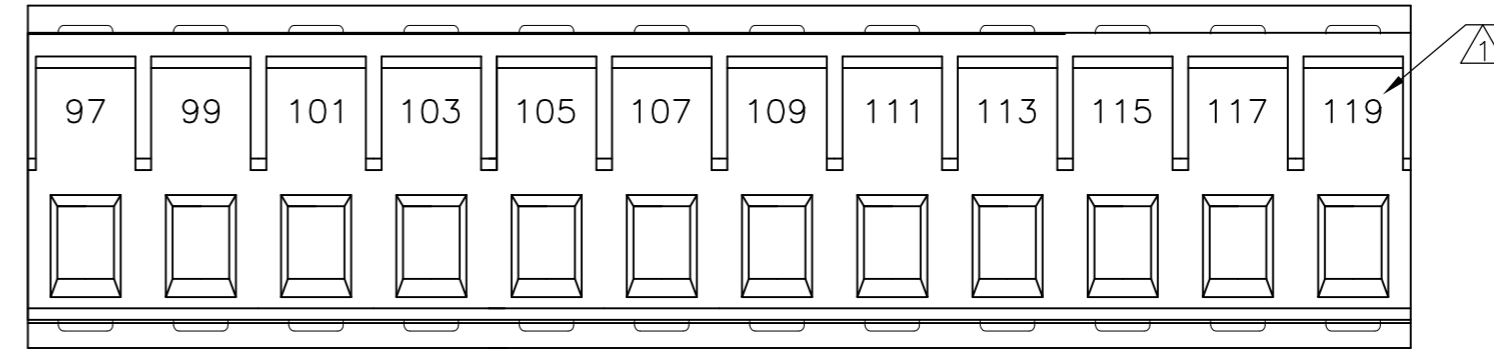

5-1776910-5

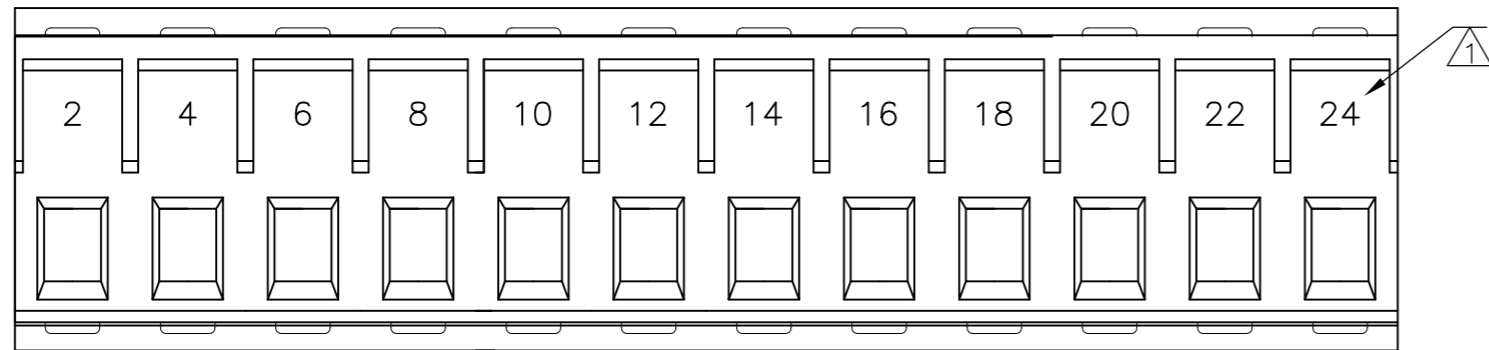

5-1776910-6

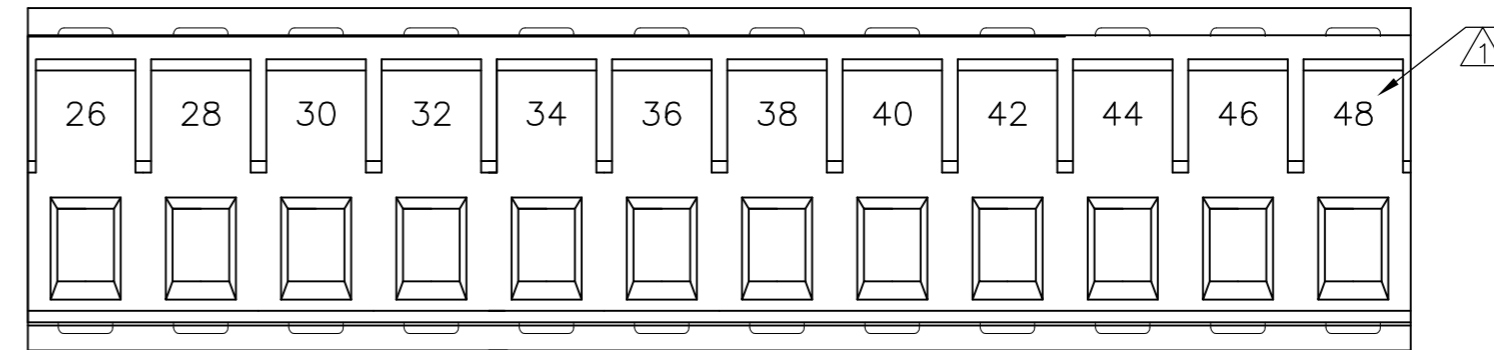

5-1776910-7

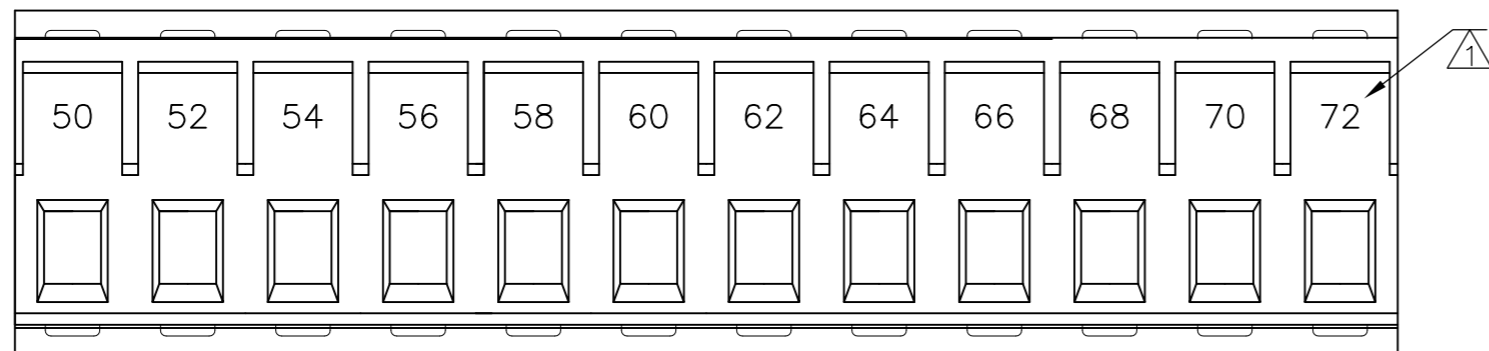

5-1776910-8

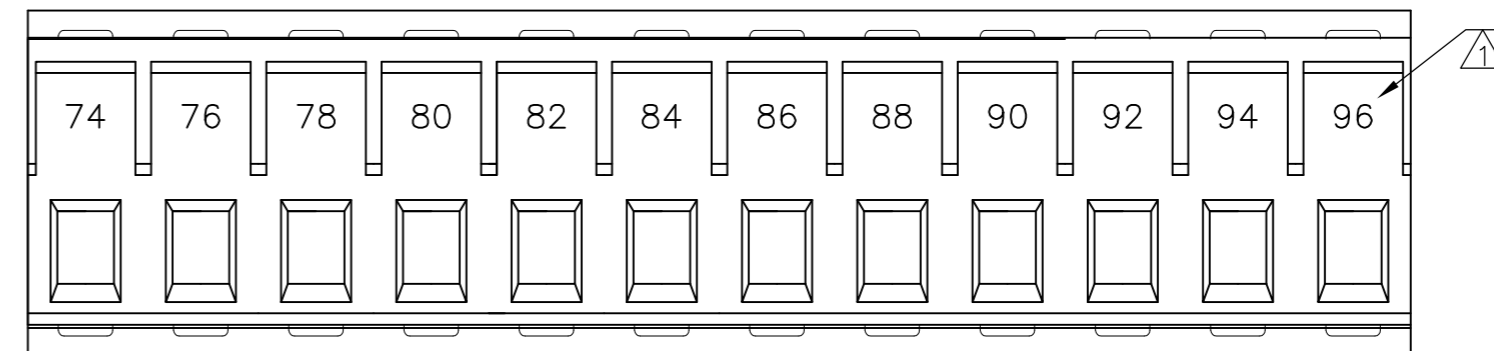

5-1776910-9

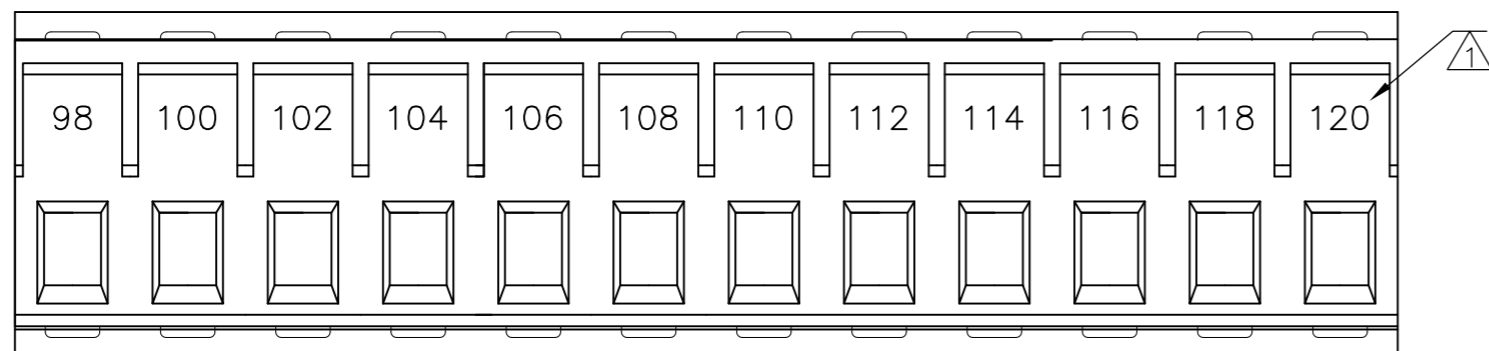

6-1776910-0

THIS DRAWING IS A CONTROLLED DOCUMENT.		DWN	S SCHLEGEL	01MAR2007		TE Connectivity			
DIMENSIONS: mm		CHK	C RICHARD	3/1/07		NAME			
TOLERANCES UNLESS OTHERWISE SPECIFIED:		APVD	C RICHARD	3/1/07		TERMINAL BLOCK, R/A PLUG, 5.08mm			
0 PLC ± - 1 PLC ± 0.3 2 PLC ± 0.25 3 PLC ± - 4 PLC ± - ANGLES ± 1° FINISH -		PRODUCT SPEC		SIZE		CAGE CODE	DRAWING NO	RESTRICTED TO	
MATERIAL		WEIGHT		-	A2	00779	C=1776910	-	
		CUSTOMER DRAWING		SCALE	NTS	SHEET	2 OF 2	REV	A4

1776910