

LOC	DIST	REVISIONS					
E	B	P	LTR	DESCRIPTION	DATE	DWN	APVD
			BA	NEW RELEASE	21-OCT-09	MRS	St.P

FOR FURTHER INFORMATION SEE DATA SHEET FOR
CRG SERIES-THICK FILM CHIP RESISTORS

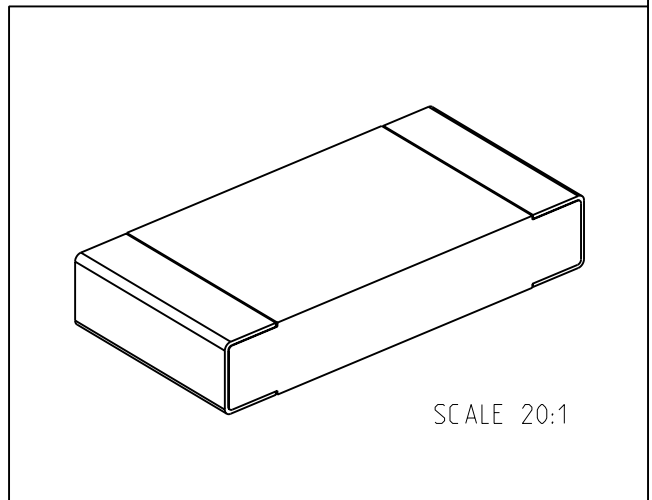

RoHS Compliant



2009

RELEASED FOR PUBLICATION

THIS DRAWING IS UNPUBLISHED.

© COPYRIGHT 2009 BY TYCO ELECTRONICS CORPORATION. ALL RIGHTS RESERVED.

DIMENSIONS: mm	DWN MAHARUDRA	21-OCT-09	MATERIAL	-	FINISH	-
	CHK ALLAN.P	21-OCT-09	Tyco Electronics Corporation Dorcan, Swindon, SN3 5HH			
TOLERANCES UNLESS OTHERWISE SPECIFIED:	APVD STEPHEN.P	21-OCT-09				
0 PLC ±0.5	PRODUCT SPEC	-	NAME THICK FILM CHIP RESISTORS SERIES CRG 1206			
1 PLC ±0.2	APPLICATION SPEC	-				
2 PLC ±0.1	WEIGHT	-	SIZE	A 4	CAGE CODE	00779
3 PLC ±-			DRAWING NO	C= 1623431		RESTRICTED TO
4 PLC ±-						-
ANGLES ±5°						
	CUSTOMER DRAWING		SCALE	30:1	SHEET	1 OF 1
						REV BA