

340kHz, 3A Synchronous DC-DC Buck Converter**AP3503E****General Description**

The AP3503E is a 340kHz fixed frequency, current mode, PWM synchronous buck (step-down) DC-DC converter, capable of driving a 3A load with high efficiency, excellent line and load regulation. The AP3503E exhibits high efficiency at light load. The device integrates N-channel power MOSFET switches with low on-resistance. Current mode control provides fast transient response and cycle-by-cycle current limit.

The AP3503E employs complete protection to ensure system security. Including output Over Voltage Protection, input Under Voltage Lock Out, programmable Soft Start, Over Temperature Protection and hiccup mode Short Circuit Protection.

This IC is available in PSOP-8 package.

Features

- Input Voltage Range: 4.5V to 18V
- Fixed 340kHz Frequency
- High Efficiency at Light Load
- High Efficiency: up to 95%
- Output Current: 3A
- Current Mode Control
- Built-in Over Current Protection
- Built-in Thermal Shutdown Function
- Built-in UVLO Function
- Built-in Over Voltage Protection
- Programmable Soft-start
- Hiccup Mode SCP

Applications

- LCD TV
- Set Top Box
- Portable DVD
- Digital Photo Frame

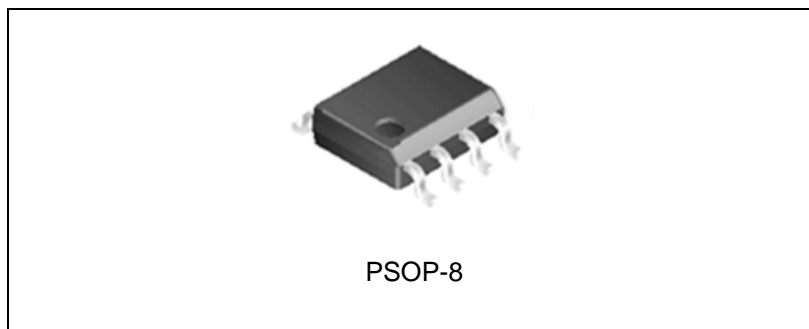

Figure 1. Package Type of AP3503E

340kHz, 3A Synchronous DC-DC Buck Converter
AP3503E
Pin Configuration

Figure 2. Pin Configuration of AP3503E (Top View)

Pin Description

Pin Number	Pin Name	Function
1	BS	Bootstrap pin. A bootstrap capacitor is connected between the BS pin and SW pin. The voltage across the bootstrap capacitor drives the internal high-side power MOSFET
2	IN	Supply power input pin. A capacitor should be connected between the IN pin and GND pin to keep the input voltage constant
3	SW	Power switch output pin. This pin is connected to the inductor and bootstrap capacitor
4	GND	Ground pin
5	FB	Feedback pin. This pin is connected to an external resistor divider to program the system output voltage. When the FB pin voltage exceeds 1.1V, the over voltage protection is triggered. When the FB pin voltage is below 0.3V, the oscillator frequency is lowered to realize short circuit protection
6	COMP	Compensation pin. This pin is the output of the transconductance error amplifier and the input to the current comparator. It is used to compensate the control loop. Connect a series RC network from this pin to GND. In some cases, an additional capacitor from this pin to GND pin is required
7	EN	Control input pin. EN is a digital input that turns the regulator on or off. Drive EN high/low to turn on/off the regulator. Pull up with 100kΩ resistor for automatic startup
8	SS	Soft-start control input pin. SS controls the soft-start period. Connect a capacitor from SS to GND to set the soft-start period. A 0.1μF capacitor sets the soft-start period to 15ms. To disable the soft-start feature, leave SS unconnected
	EP	Exposed pad. It should be connected to GND in PCB layout

340kHz, 3A Synchronous DC-DC Buck Converter

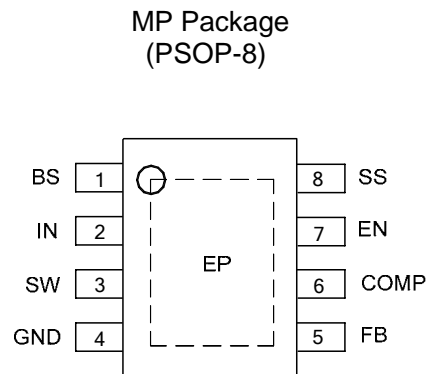
AP3503E

Functional Block Diagram

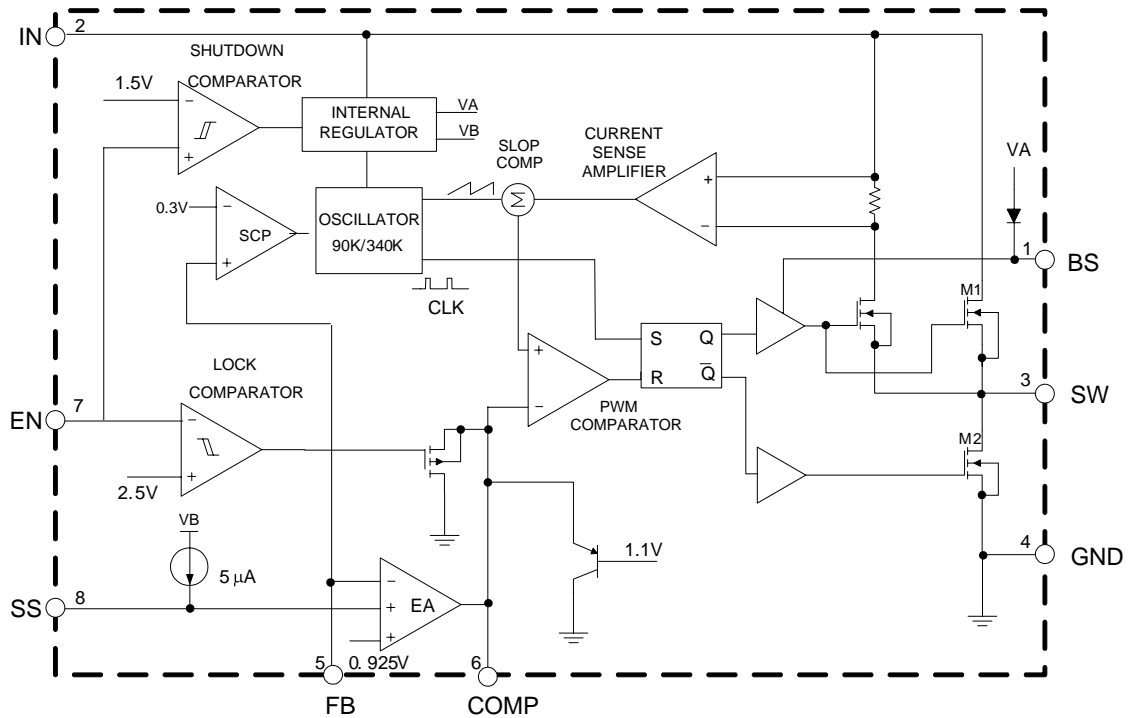
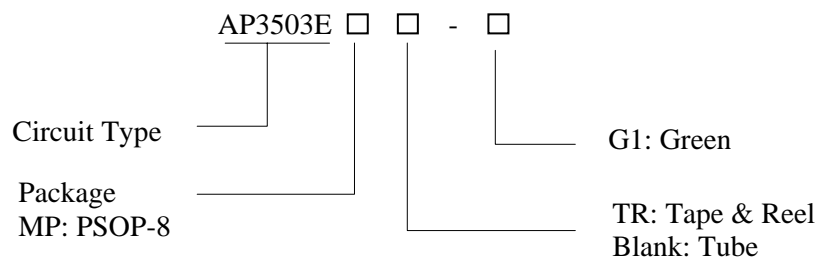

Figure 3. Functional Block Diagram of AP3503E

Ordering Information



Package	Temperature Range	Part Number	Marking ID	Packing Type
PSOP-8	-40 to 85°C	AP3503EMP-G1	3503EMP-G1	Tube
		AP3503EMPTR-G1	3503EMP-G1	Tape & Reel

BCD Semiconductor's Pb-free products, as designated with "G1" suffix in the part number, are RoHS compliant and green.

**340kHz, 3A Synchronous DC-DC Buck Converter****AP3503E****Absolute Maximum Ratings (Note 1)**

Parameter	Symbol	Value	Unit
IN Pin Voltage	V_{IN}	-0.3 to 20	V
EN Pin Voltage	V_{EN}	-0.3 to V_{IN}	V
SW Pin Voltage	V_{SW}	21	V
BS Pin Voltage	V_{BS}	-0.3 to $V_{SW}+6$	V
FB Pin Voltage	V_{FB}	-0.3 to 6	V
COMP Pin Voltage	V_{COMP}	-0.3 to 6	V
SS Pin Voltage	V_{SS}	-0.3 to 6	V
Thermal Resistance	θ_{JA}	60	°C/W
Operating Junction Temperature	T_J	150	°C
Storage Temperature	T_{STG}	-65 to 150	°C
Lead Temperature (Soldering, 10sec)	T_{LEAD}	260	°C
ESD (Human Body Model)	V_{HBM}	2000	V
ESD (Machine Model)	V_{MM}	200	V

Note 1: Stresses greater than those listed under “Absolute Maximum Ratings” may cause permanent damage to the device. These are stress ratings only, and functional operation of the device at these or any other conditions beyond those indicated under “Recommended Operating Conditions” is not implied. Exposure to “Absolute Maximum Ratings” for extended periods may affect device reliability.

Recommended Operating Conditions

Parameter	Symbol	Min	Max	Unit
Input Voltage	V_{IN}	4.5	18	V
Operating Ambient Temperature	T_A	-40	85	°C



340kHz, 3A Synchronous DC-DC Buck Converter

AP3503E

Electrical Characteristics

T_A=25°C, V_{IN}=V_{EN}=12V, V_{OUT}=3.3V, unless otherwise specified.

Parameter	Symbol	Conditions	Min	Typ	Max	Unit
SUPPLY VOLTAGE (IN PIN)						
Input Voltage	V _{IN}		4.5		18	V
Quiescent Current	I _Q	V _{FB} =1V, V _{EN} =3V		1.2	1.4	mA
Shutdown Supply Current	I _{SHDN}	V _{EN} =0V		0.1	10	μA
UNDER VOLTAGE LOCKOUT						
Input UVLO Threshold	V _{UVLO}	V _{IN} Rising	3.65	4.00	4.25	V
Input UVLO Hysteresis	V _{HYS}			200		mV
ENABLE (EN PIN)						
EN Shutdown Threshold Voltage			1.1	1.5	2	V
EN Shutdown Threshold Voltage Hysteresis (Note 3)				350		mV
EN Lockout Threshold Voltage			2.2	2.5	2.7	V
EN Lockout Hysteresis				210		mV
VOLTAGE REFERENCE (FB PIN)						
Feedback Voltage	V _{FB}		0.907	0.925	0.943	V
Feedback Over Voltage Threshold	V _{FBOV}			1.1		V
Feedback Bias Current	I _{FB}	V _{FB} =1V	-0.1		0.1	μA
MOSFET						
High-side Switch On-resistance(Note 2)	R _{DSONH}	I _{SW} =0.2A/0.7A		100		mΩ
Low-side Switch On-resistance(Note 2)	R _{DSONL}	I _{SW} =-0.2A/-0.7A		100		mΩ
CURRENT LIMIT						
High-side Switch Leakage Current	I _{LEAKH}	V _{IN} =18V, V _{EN} =V _{SW} =0V		0.1	10	μA
High-side Switch Current Limit	I _{LIMH}		4.3	5.6		A
Low-side Switch Current Limit	I _{LIML}	Drain to Source		0		mA
SWITCHING REGULATOR						
Oscillator Frequency	f _{OSC1}		280	340	400	kHz
Short Circuit Oscillator Frequency	f _{OSC2}			90		kHz
Max. Duty Cycle	D _{MAX}	V _{FB} =0.85V		90		%
Min. Duty Cycle	D _{MIN}	V _{FB} =1V			0	%
ERROR AMPLIFIER						
Error Amplifier Voltage Gain (Note 3)	A _{EA}			400		V/V
Error Amplifier Transconductance	G _{EA}			800		μA/V
COMP to Current Sense Transconductance	G _{CS}			5.2		A/V
THERMAL SHUTDOWN						
Thermal Shutdown (Note 3)	T _{OTSD}			160		°C
Thermal Shutdown Hysteresis (Note 3)	T _{HYS}			20		°C
SOFT START (SS PIN)						
Soft-start Time (Note 3)	t _{SS}	C4=0.1μF, I _{OUT} =500mA		15		ms
Soft-start Current				5		μA

Note 2: $R_{DSON} = \frac{V_{SW1} - V_{SW2}}{I_{SW1} - I_{SW2}}$

Note 3: Not tested, guaranteed by design.



340kHz, 3A Synchronous DC-DC Buck Converter

AP3503E

Typical Performance Characteristics

$T_A=25^{\circ}\text{C}$, $V_{IN}=12\text{V}$, $V_{OUT}=3.3\text{V}$, unless otherwise noted.

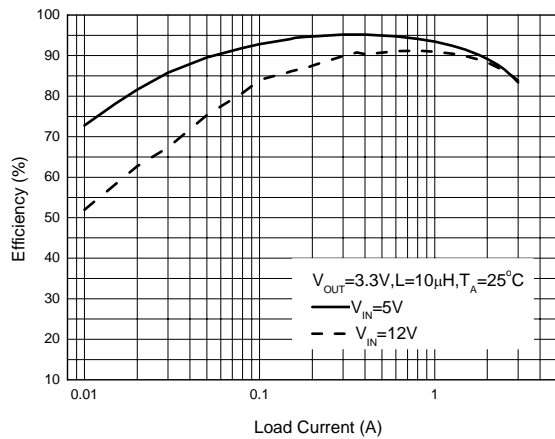

Figure 4. Efficiency vs. Load Current

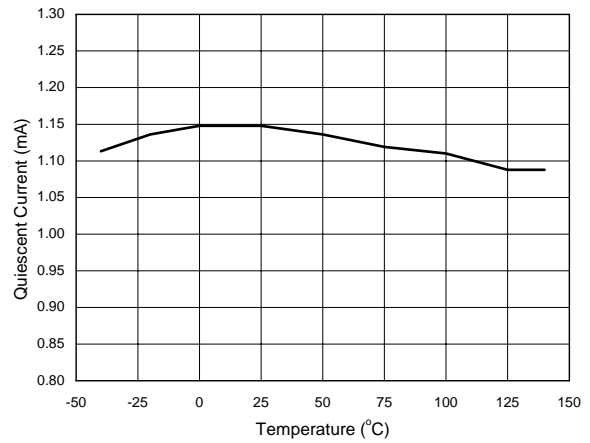

Figure 5. Quiescent Current vs. Temperature

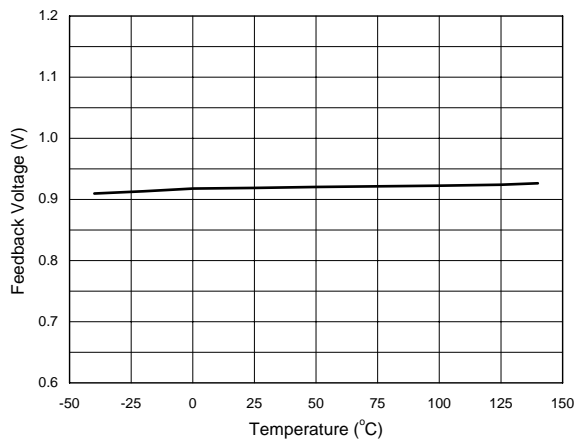

Figure 6. Feedback Voltage vs. Temperature

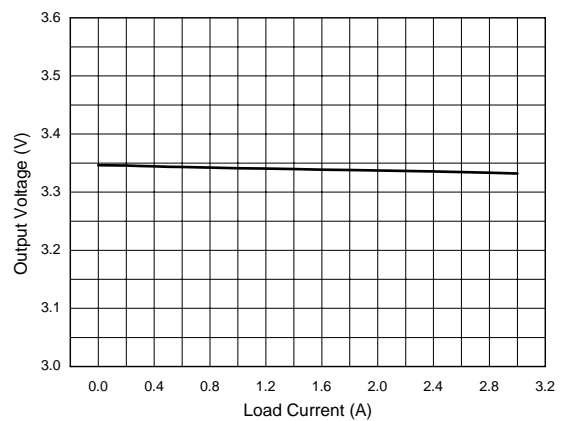

Figure 7. Output Voltage vs. Load Current

340kHz, 3A Synchronous DC-DC Buck Converter

AP3503E

Typical Performance Characteristics (Continued)

$T_A=25^\circ\text{C}$, $V_{IN}=12\text{V}$, $V_{OUT}=3.3\text{V}$, unless otherwise noted.

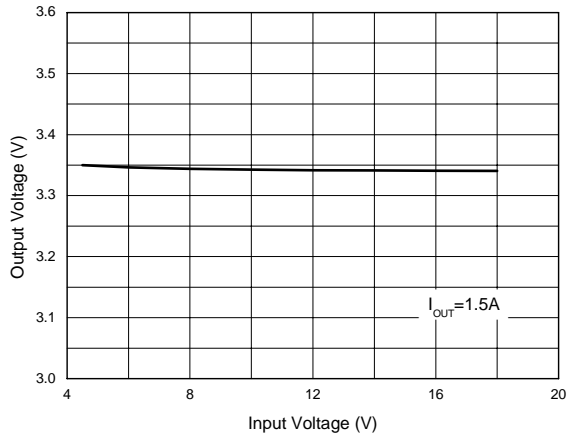

Figure 8. Output Voltage vs. Input Voltage

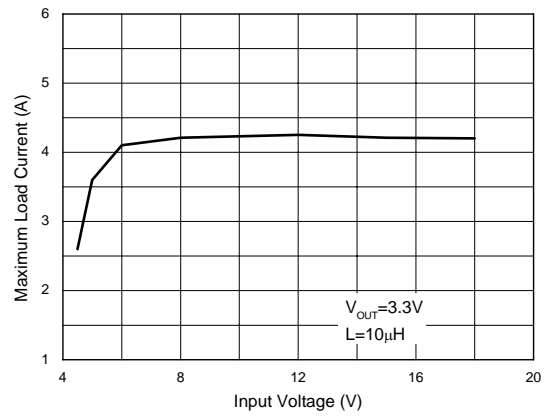

Figure 9. Maximum Load Current vs. Input Voltage

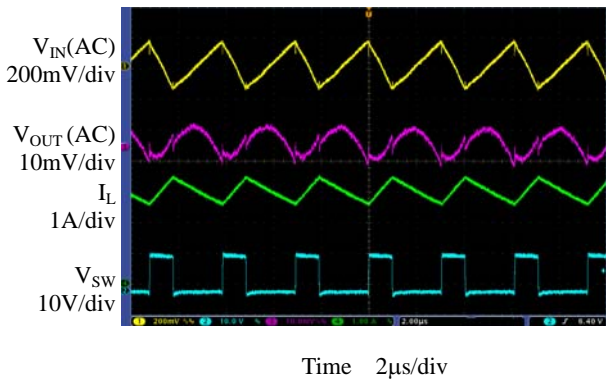

Figure 10. Output Ripple ($I_{OUT}=3\text{A}$)

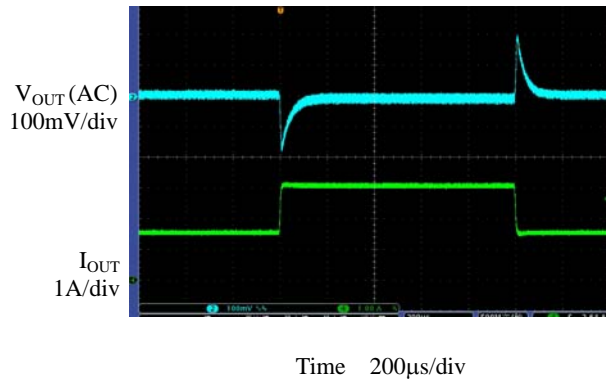
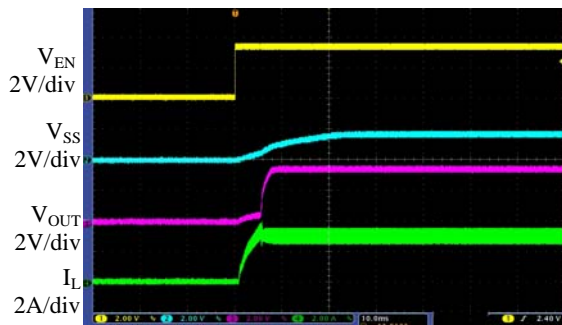
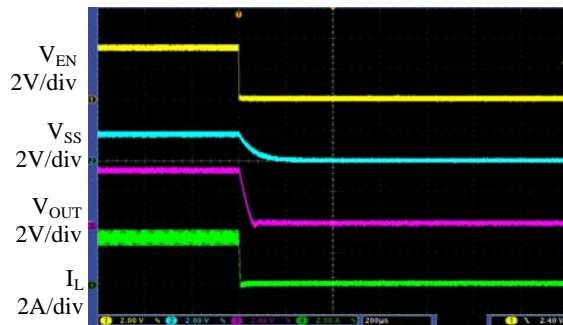

Figure 11. Load Transient ($I_{OUT}=1.5$ to 3A)

340kHz, 3A Synchronous DC-DC Buck Converter
AP3503E
Typical Performance Characteristics (Continued)
 $T_A=25^\circ\text{C}$, $V_{IN}=12\text{V}$, $V_{OUT}=3.3\text{V}$, unless otherwise noted.

Time 10ms/div

 Figure 12. Enable Turn-on Characteristic ($V_{IN}=12\text{V}$, $V_{EN}=3.3\text{V}$, $V_{OUT}=3.3\text{V}$, $I_{OUT}=3\text{A}$)

Time 200µs/div

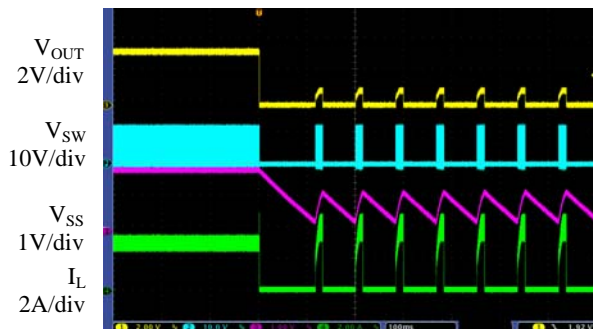
 Figure 13. Enable Turn-off Characteristic ($V_{IN}=12\text{V}$, $V_{EN}=3.3\text{V}$, $V_{OUT}=3.3\text{V}$, $I_{OUT}=3\text{A}$)

Time 100ms/div

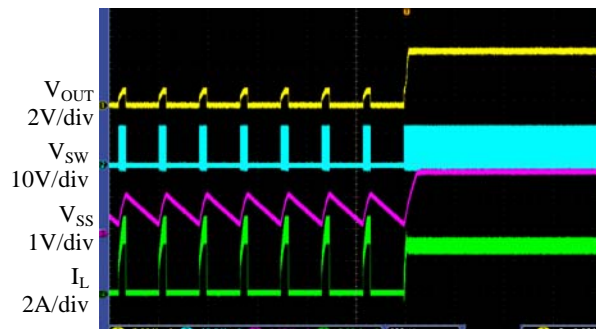
 Figure 14. Short Circuit Protection ($I_{OUT}=3\text{A}$)

Time 100ms/div

 Figure 15. Short Circuit Recovery ($I_{OUT}=3\text{A}$)

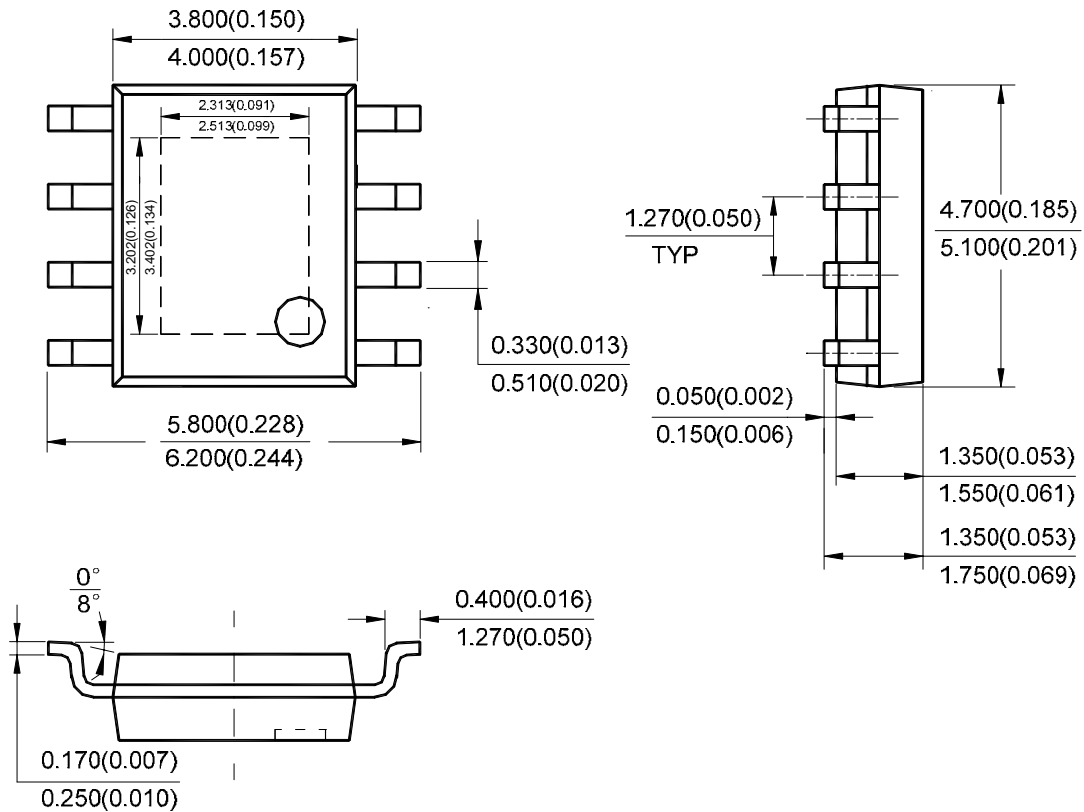
Mechanical Dimensions
PSOP-8
Unit: mm(inch)

Note: Eject hole, oriented hole and mold mark is optional.



BCD Semiconductor Manufacturing Limited

<http://www.bcdsemi.com>

IMPORTANT NOTICE

BCD Semiconductor Manufacturing Limited reserves the right to make changes without further notice to any products or specifications herein. BCD Semiconductor Manufacturing Limited does not assume any responsibility for use of any its products for any particular purpose, nor does BCD Semiconductor Manufacturing Limited assume any liability arising out of the application or use of any its products or circuits. BCD Semiconductor Manufacturing Limited does not convey any license under its patent rights or other rights nor the rights of others.

MAIN SITE

- Headquarters

BCD Semiconductor Manufacturing Limited

No. 1600, Zi Xing Road, Shanghai ZiZhu Science-based Industrial Park, 200241, China
Tel: +86-21-24162266, Fax: +86-21-24162277

- Wafer Fab

Shanghai SIM-BCD Semiconductor Manufacturing Co., Ltd.

800 Yi Shan Road, Shanghai 200233, China
Tel: +86-21-6485 1491, Fax: +86-21-5450 0008

REGIONAL SALES OFFICE

Shenzhen Office

Shanghai SIM-BCD Semiconductor Manufacturing Co., Ltd., Shenzhen Office

Unit A Room 1203, Skyworth Bldg., Gaoxin Ave. 1.S., Nanshan District, Shenzhen, China
Tel: +86-755-8826 7951
Fax: +86-755-8826 7865

Taiwan Office

BCD Semiconductor (Taiwan) Company Limited

4F, 298-1, Rui Guang Road, Nei-Hu District, Taipei, Taiwan
Tel: +886-2-2656 2808
Fax: +886-2-2656 2806

USA Office

BCD Semiconductor Corp.

30920 Huntwood Ave. Hayward, CA 94544, USA
Tel : +1-510-324-2988
Fax: +1-510-324-2788