

- NOTES:**
- LED MOUNTING: for 5mm LEDs - round or rectangular shape with or without flange. Bi-lead, standard .100 [2.54mm] lead spacing. Tri-lead, either .050 [1.27mm] or .100 [2.54mm] lead spacing. Both the bi-lead and tri-lead LEDs can also be combined in arrays with one another.
 - ASSEMBLY: Can be used as a single LED mount or banded together in an array with its dovetail interlocking feature. When banded together with the PCH 175 the LEDs are on .250 [6.35mm] centers.
 - MATERIAL: Housing - Nylon 6/6, U.L. 94 V0 Rating, Color black (unless otherwise spec.)
 - U.S. & Foreign Pat. Issued & Pend.
 - LED shown for illustrative purposes.

REVISIONS				
ECN#	REV.	DESCRIPTION	DATE	INITIALS
	001	REVISED PER ECR111009AZ01	6-20-10	SMU
	002	CORRECTED FORMAT FOR "A" DRAWING & NEW TITLEBLOCK	8/29/14	MB

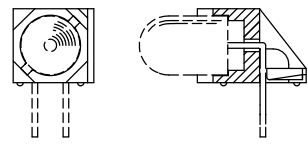
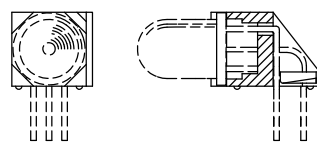
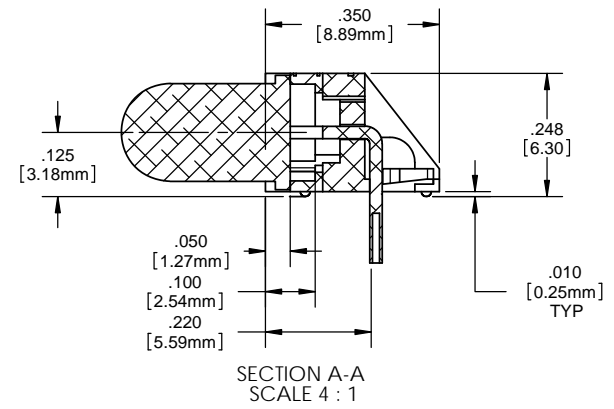
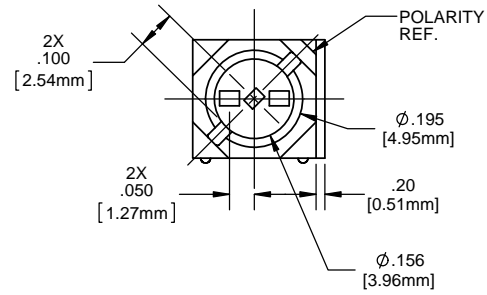
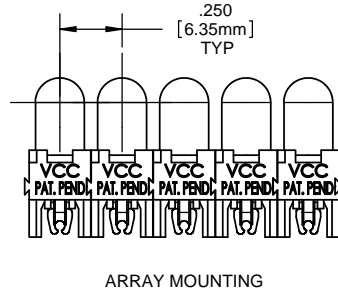
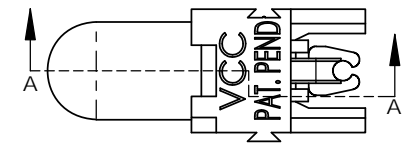
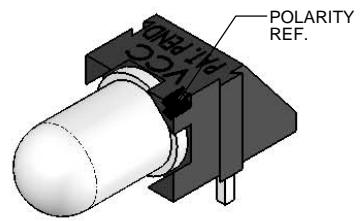
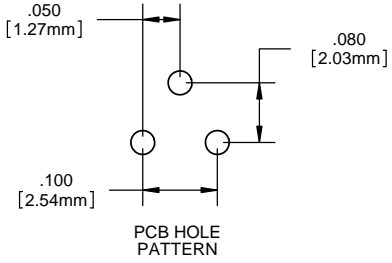

PROPRIETARY AND CONFIDENTIAL
 THE INFORMATION CONTAINED IN THIS DRAWING IS THE SOLE PROPERTY OF VISUAL COMMUNICATIONS COMPANY, LLC. ANY REPRODUCTION IN PART OR AS A WHOLE WITHOUT THE WRITTEN PERMISSION OF VISUAL COMMUNICATIONS COMPANY, LLC IS PROHIBITED.

DIMENSION STYLE: INCHES [MM]		
GENERAL TOLERANCES UNLESS OTHERWISE SPECIFIED		
	INCHES	MM
X	± .020	± .508
XX	± .010	± .254
XXX	± .005	± .127
ANGLE ± 1°		
BREAK ALL CORNERS AND SHARP EDGES .030 MAX		
THIRD ANGLE PROJECTION		

MATERIAL	
NYLON 6/6, UL 94-V0, BLACK (UNLESS OTHERWISE SPEC.)	
FINISH	
APPROVAL	DATE
DRAWN: SMU	6/20/10
CHECKED: DZ	6/20/10
DO NOT SCALE DRAWING	

 12780 DANIELSON CT, SUITE A, POWAY, CA. 92064 U.S.A PHONE: (800) 522-5546 EMAIL: vccsales@vccllite.com		TITLE:	
		P-C-LITE® RT ANGLE MOUNT	
PART #		SIZE	
PCH_175		B	
DRAWING #		REV	
PCH 175		002	
SCALE: 1:1		SHEET 1 OF 1	