

LISA2-R-PIN

White mini reflector with ~80° wide beam. 6.5 mm high with location pin installation.

TECHNICAL SPECIFICATIONS:

Dimensions	Ø 9.9 mm
Height	6.5 mm
Fastening	glue, pin
Colour	white
Box size	254 x 298 x 241 mm
Box weight	4.1 kg
Quantity in Box	10000 pcs
ROHS compliant	yes ⓘ



MATERIAL SPECIFICATIONS:

Component	Type	Material	Colour	Coating
LISA2-R-PIN	Reflector	HRPC	white	

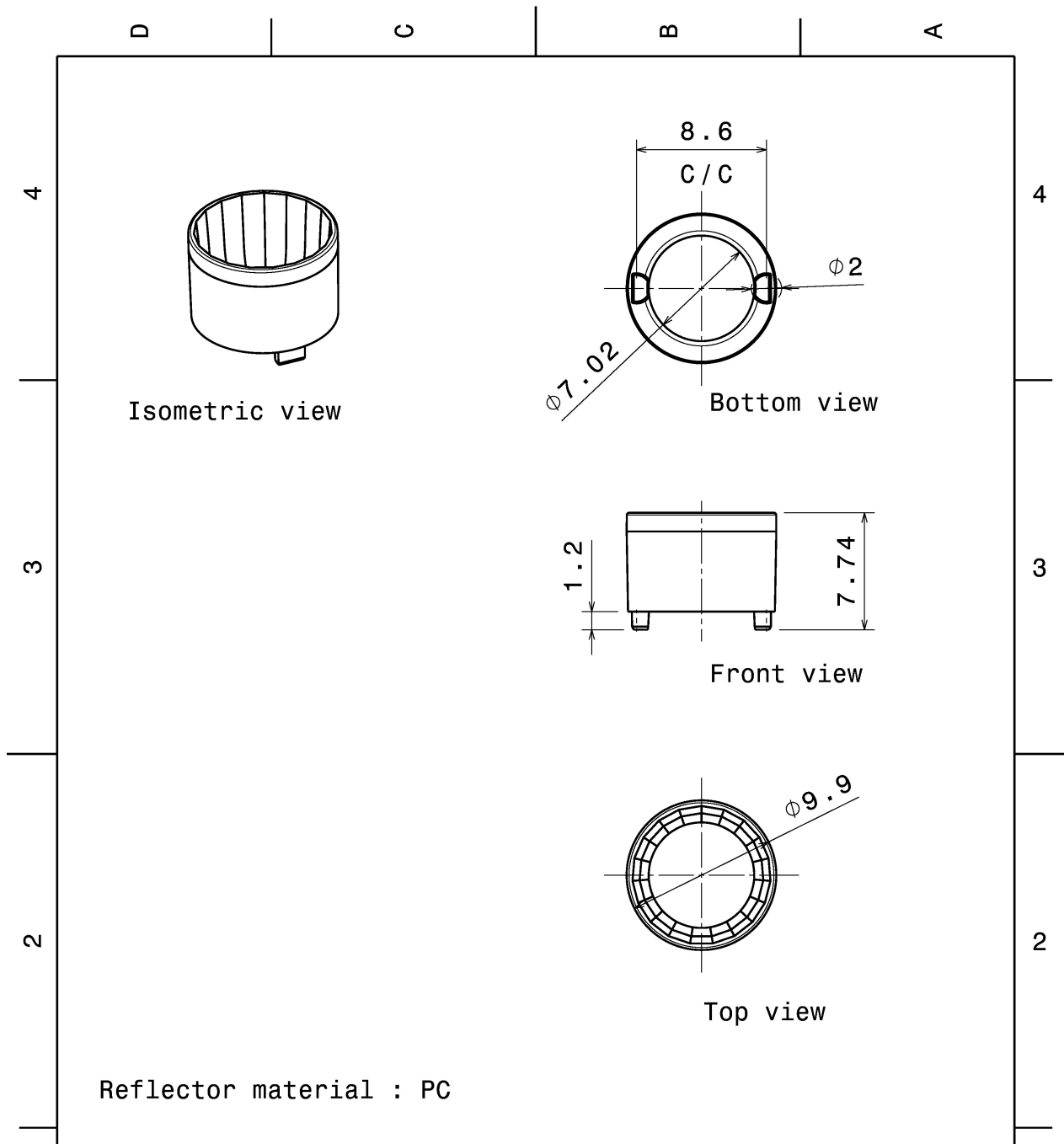

Reflector material : PC

Tolerances if not otherwise shown
According to DIN ISO 2768-1
Linear measures:
Up to 30mm class M, otherwise class C.
According to DIN ISO 2768-2
Form and position: class L

LEDiL Ledil Oy
Salorankatu 10
FIN 24240 SALO
Finland

THIRD ANGLE PROJECTION:

DRAWING TITLE
Datasheet_Lisa2-reflector

This drawing is the property of LEDiL Oy. It may not be reproduced, copied or communicated without a written agreement with LEDiL Oy."

SIZE	PART NUMBER
A4	-

SCALE	3:1	WEIGHT	-	SHEET	1/1
-------	-----	--------	---	-------	-----

PHOTOMETRIC DATA (MEASURED):

CREE

LED XB-D
FWHM 81.0°
Efficiency 87 %
Peak intensity 0.380 cd/lm
Required components:

CREE

LED XP-E
FWHM 82.0°
Efficiency 86 %
Peak intensity 0.350 cd/lm
Required components:

CREE

LED XP-G
FWHM 86.0°
Efficiency 89 %
Peak intensity 0.330 cd/lm
Required components:

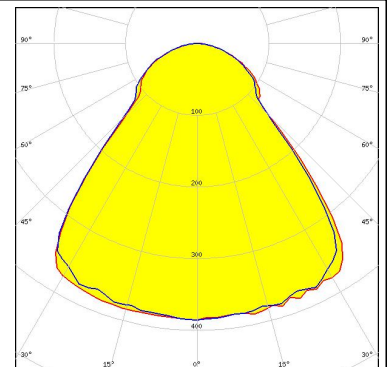

CREE

LED XP-G3
FWHM 86.0°
Efficiency 88 %
Peak intensity 0.380 cd/lm
Required components:

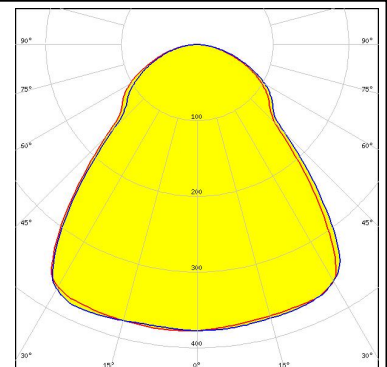
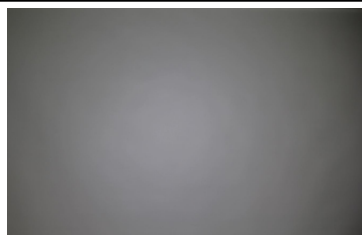

PHOTOMETRIC DATA (MEASURED):



LED XT-E
FWHM 80.0°
Efficiency 85 %
Peak intensity 0.460 cd/lm
Required components:

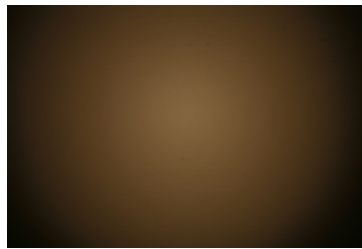

LED LUXEON A
FWHM 83.0°
Efficiency 88 %
Peak intensity 0.370 cd/lm
Required components:



LED LUXEON C
FWHM 84.0°
Efficiency 83 %
Peak intensity 0.380 cd/lm
Required components:

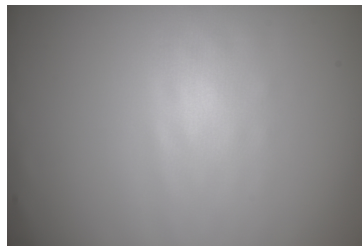

LED LUXEON Rebel
FWHM 77.0°
Efficiency 88 %
Peak intensity 0.410 cd/lm
Required components:

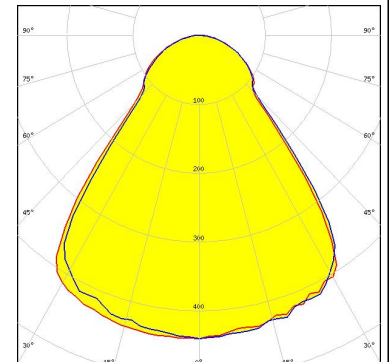
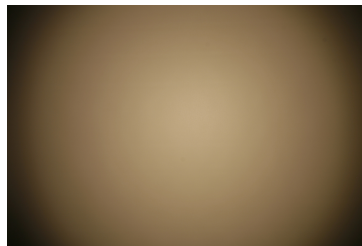

PHOTOMETRIC DATA (MEASURED):

LUMILEDS

LED LUXEON Rebel ES
FWHM 83.0°
Efficiency 90 %
Peak intensity 0.360 cd/lm
Required components:

LUMILEDS

LED LUXEON T
FWHM 82.0°
Efficiency 82 %
Peak intensity 0.400 cd/lm
Required components:

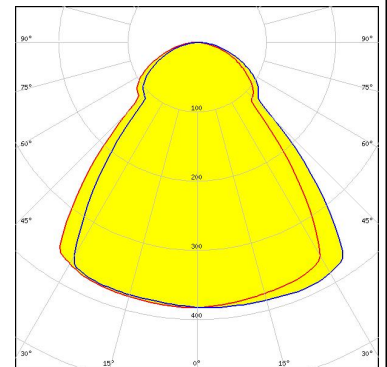
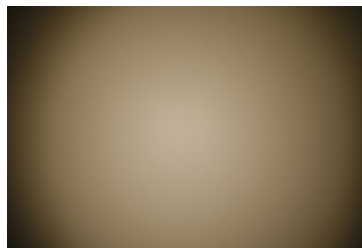

LUMILEDS

LED LUXEON Z
FWHM 78.0°
Efficiency 86 %
Peak intensity 0.440 cd/lm
Required components:

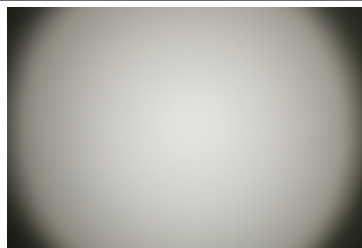

NICHIA

LED NCSxx19A
FWHM 78.0°
Efficiency 84 %
Peak intensity 0.460 cd/lm
Required components:

PHOTOMETRIC DATA (MEASURED):



LED NVSxx19A
 FWHM 80.0°
 Efficiency 84 %
 Peak intensity 0.400 cd/lm
 Required components:



LED OSCONIQ P 2226
 FWHM 78.0°
 Efficiency 83 %
 Peak intensity 0.400 cd/lm
 Required components:

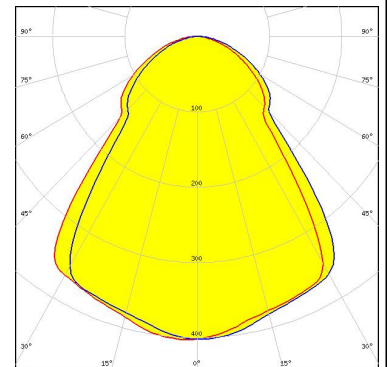
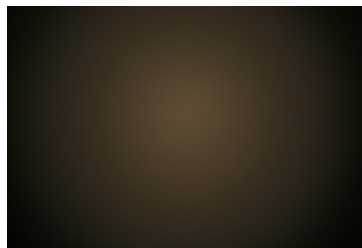

LED Oslon Square EC
 FWHM 82.0°
 Efficiency 85 %
 Peak intensity 0.370 cd/lm
 Required components:

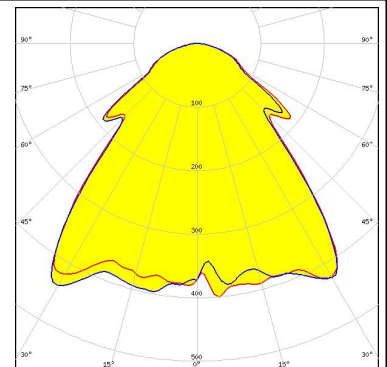
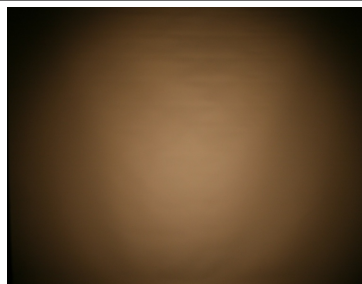

LED Oslon SSL 150
 FWHM 83.0°
 Efficiency 91 %
 Peak intensity 0.300 cd/lm
 Required components:

PHOTOMETRIC DATA (MEASURED):

OSRAM
Opto Semiconductors

LED Oslon SSL 80
FWHM 76.0°
Efficiency 92 %
Peak intensity 0.500 cd/lm
Required components:

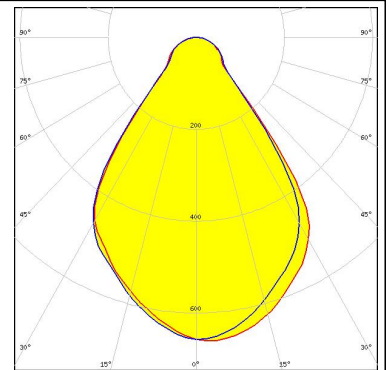

SEOL
SEOUL SEMICONDUCTOR

LED Z5
FWHM 80.0°
Efficiency 84 %
Peak intensity 0.360 cd/lm
Required components:

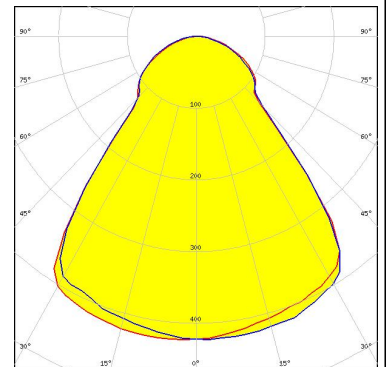

SEOL
SEOUL SEMICONDUCTOR

LED Z8Y15
FWHM 76.0°
Efficiency 87 %
Peak intensity 0.430 cd/lm
Required components:

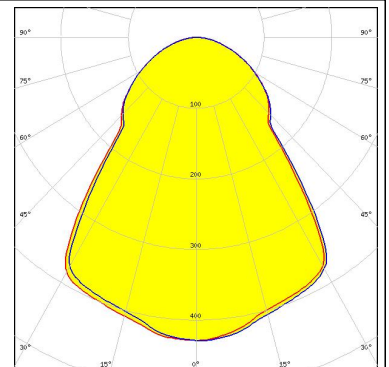
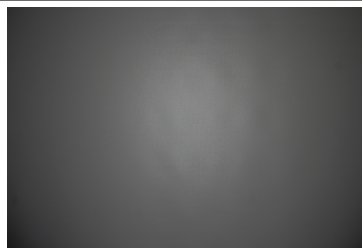

SEOL
SEOUL SEMICONDUCTOR

LED Z8Y19
FWHM 76.0°
Efficiency 86 %
Peak intensity 0.435 cd/lm
Required components:

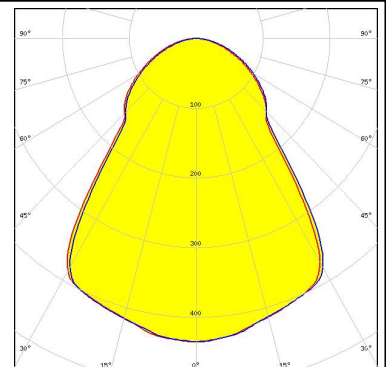
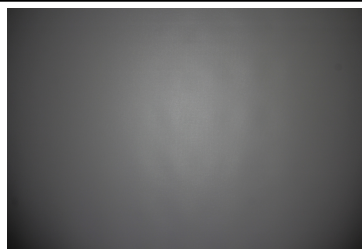

PHOTOMETRIC DATA (SIMULATED):



LED XD16
FWHM 82.0°
Efficiency 83 %
Peak intensity 0.360 cd/lm
Required components:

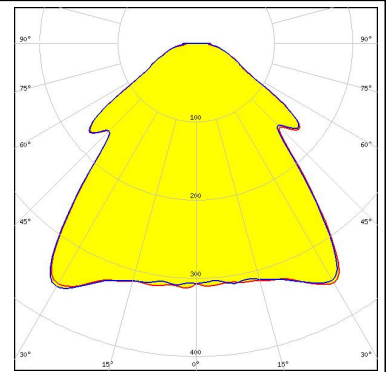

LED XHP35 HD
FWHM 91.0°
Efficiency 92 %
Peak intensity 0.370 cd/lm
Required components:

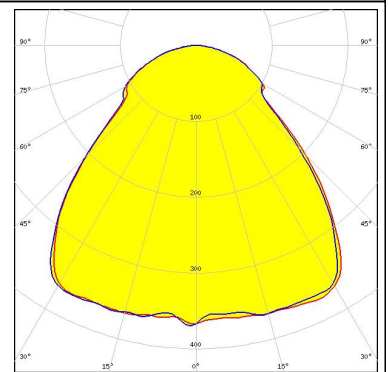

LED XP-L
FWHM 81.0°
Efficiency 83 %
Peak intensity 0.360 cd/lm
Required components:

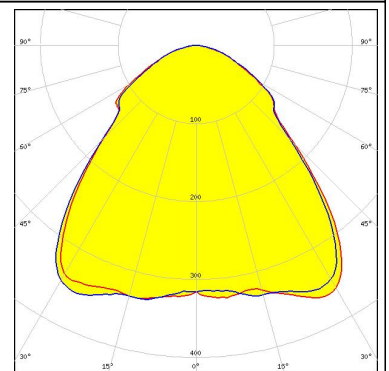

LED XQ-E
FWHM 76.0°
Efficiency 90 %
Peak intensity 0.450 cd/lm
Required components:

PHOTOMETRIC DATA (SIMULATED):



LED LUXEON H50-2
FWHM 80.0°
Efficiency 90 %
Peak intensity 0.440 cd/lm
Required components:

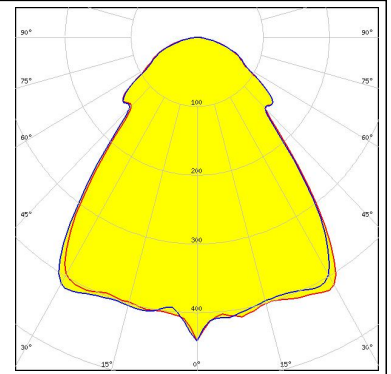

GENERAL INFORMATION:

NOTE: The typical beam angle will be changed by different color, chip size and chip position tolerance. The typical total beam angle is the full angle measured where the luminous intensity is half of the peak value.

MATERIALS:

As part of our continuous research and improvement processes, and to ensure the best possible quality and availability of our products, LEDiL reserves the right to change material grades without notice.

PRODUCT DATA USER AGREEMENT AND DISCLAIMER:

The measured data in the provided downloadable LEDiL Product Datasheets and Mechanical 2D-Drawings is rounded and provided as reference for planning. LEDiL Oy's optical specifications have been verified by conducting performance testing of the products in accordance with the company's quality system. The reported data are averaged results of multiple measurements with typical variation. LEDiL Oy reserves the right to without prior notification make changes and improvements to its products.

LEDiL Oy assumes neither warranty, nor guarantee nor any other liability of any kind for the contents and correctness of the provided data. The provided data has been generated with highest diligence but the provided data may in reality not represent the complete possible variation range of all intrinsic parameters. Therefore, in certain cases a deviation from the provided data could occur.

LEDiL Oy reserves the right to undertake technical changes of its products without further notification which could lead to changes in the provided data. LEDiL Oy assumes no liability of any kind for the possible deviation from any provided data or any other damage resulting from the usage of the provided data.

The user agrees to this disclaimer and user agreement with the download or usage of the provided files.

LEDiL Oy

Joensuunkatu 13
FI-24240 SALO
Finland

LEDiL Inc.

228 West Page Street
Suite D
Sycamore IL 60178
USA

Local sales and technical support

[www.ledil.com/
where_to_buy](http://www.ledil.com/where_to_buy)

Shipping locations

Salo, Finland
Hong Kong, China

Distribution Partners

[www.ledil.com/
where_to_buy](http://www.ledil.com/where_to_buy)