

AXL E IOL AO1 U M12 S

Axioline E IO-Link/analog converter for connecting an analog actuator, 0 V ... 10 V, straight version



Data sheet
8595_en_04

© PHOENIX CONTACT 2015-04-28

1 Description

The IO-Link/analog converter is an IO-Link slave that converts the IO-Link protocol into analog signals.

It therefore offers the option of transmitting signals to analog actuators via an IO-Link master.

Features

- Straight version
- 1 IO-Link interface
- 1 analog output
- Connection of the actuator in 3-wire technology
- Voltage range: 0 V ... 10 V
- IO-Link and actuator connections via M12 connectors
- FE connection for local connection to functional earth ground
- Supply of the module electronics and the actuator via the IO-Link interface of the IO-Link master
- Diagnostic indicator



Make sure you always use the latest documentation.
It can be downloaded from the product at phoenixcontact.net/products.

2	Table of contents	
1	Description	1
2	Table of contents	2
3	Ordering data	3
4	Technical data	3
5	Additional tables	5
6	Internal circuit diagram	5
7	Pin assignment	6
	7.1 Connections on the device	6
	7.2 Pin assignment of the IO-Link interface	6
	7.3 Pin assignment of the analog output	6
8	Connection notes	6
9	Connection example.....	6
10	Assembly.....	7
11	Local status indicator.....	7
12	Process data.....	8
	12.1 IN process data	8
	12.2 OUT process data.....	9
	12.3 Parameterization via OUT process data	9
	12.4 Example	9
13	Significant values in various formats.....	10
	13.1 IB IL format	10
	13.2 S7-compatible format	10
14	IO-Link objects	11
	14.1 Overview of the objects	11
	14.2 Parameterization (80 _{hex} : ParaWord)	12

3 Ordering data

Description	Type	Order No.	Pcs. / Pkt.
Axioline E IO-Link/analog converter for connecting an analog actuator, 0 V ... 10 V, M12 fast connection technology, straight version	AXL E IOL AO1 U M12 S	2700350	1

4 Technical data

Dimensions (nominal sizes in mm)

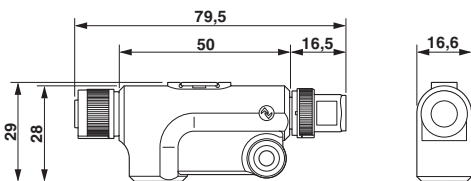

Width	16.6 mm
Height	29 mm
Depth	79.5 mm

General data

Weight	34 g
Ambient temperature (operation)	-25 °C ... 60 °C
Ambient temperature (storage/transport)	-25 °C ... 85 °C
Permissible humidity (operation)	5 % ... 95 %
Permissible humidity (storage/transport)	5 % ... 95 %
Air pressure (operation)	70 kPa ... 106 kPa (up to 3000 m above sea level)
Air pressure (storage/transport)	70 kPa ... 106 kPa (up to 3000 m above sea level)
Degree of protection	IP65/67
Protection class	III, IEC 61140, EN 61140, VDE 0140-1
Pollution degree	2

IO-Link

Specification	V1.1.1
Protection against polarity reversal	Yes
Transmission speed	230,4 kBit/s (COM3)
Frame type	1
Cycle Time	min. 2 ms
Process data update	2 ms
Amount of process data	16 Bit (Input data), 16 Bit (Output data)

IO-Link ports

Number of ports	1
Connection method	M12 connector, A-coded

IO-Link port supply

Typical current consumption	16.5 mA ±15% (at 24 V DC)
Current consumption	max. 135 mA
Protection against polarity reversal	Yes
Short-circuit protection	Yes
Overload protection	Yes
I/O supply voltage	24 V DC This supply voltage is provided via the IO-Link interface of the IO-Link master.
Sensor supply voltage	24 V DC (max. 100 mA) This supply voltage is provided via the I/O supply voltage.

Analog output

Number of outputs	1 (voltage)
Connection method	M12 connector, A-coded
Connection method	3-conductor
Voltage output signal	0 V ... 10 V
Load/output load voltage output	min. 10 kΩ
D/A resolution	12 bit
Data formats	IB IL, S7-compatible
Precision	< 0.25 % (of output range final value in the nominal range)
Permissible cable length	max. 30 m (Shielded cable)

Error messages to the higher level control or computer system

Short circuit	Message in the diagnostic code (in the IB IL format)
Configuration invalid	Message in the diagnostic code (in the IB IL format)
Module faulty	Message in the diagnostic code (in the IB IL format)

Mechanical tests

Vibration resistance in acc. with EN 60068-2-6/IEC 60068-2-6	Operation: 2g
Vibration resistance in acc. with EN 60068-2-6/IEC 60068-2-6	Storage/transport: 5g
Shock in acc. with EN 60068-2-27/IEC 60068-2-27	Operation: 30g, 11 ms, three shocks in each space direction
Shock in acc. with EN 60068-2-27/IEC 60068-2-27	Storage/transport: 50g, 11 ms, three shocks in each space direction
Continuous shock according to EN 60068-2-27/IEC 60068-2-27	10g, 16 ms, 1000 shocks, in all space directions

Approvals

For the latest approvals, please visit phoenixcontact.net/products.

5 Additional tables

The data is valid for nominal operation (supply voltage = 24 V) in the default configuration (measurement range 0 V ... 10 V).

Tolerance and temperature response at $T_A = -25^\circ\text{C}$ to $+60^\circ\text{C}$	
Drift	
Typical	Maximum
± 25 ppm/K	± 75 ppm/K

The tolerance values refer to the measuring range final value.

Tolerances influenced by electromagnetic interference			
Type of electromagnetic interference	Standard	Tolerance	Criterion
Electromagnetic fields	EN 61000-4-3/ IEC 61000-4-3	$< \pm 1.0\%$	A
Fast transients (burst)	EN 61000-4-4/ IEC 61000-4-4	$< \pm 1.0\%$	A
Conducted interference	EN 61000-4-6/ IEC 61000-4-6	$< \pm 1.0\%$	A

6 Internal circuit diagram

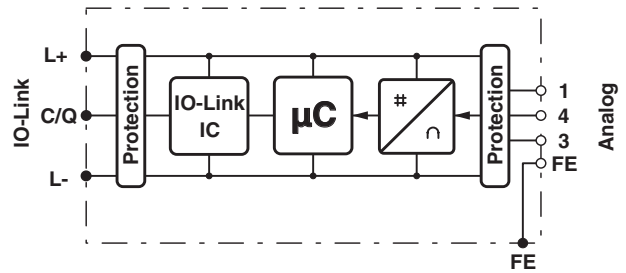
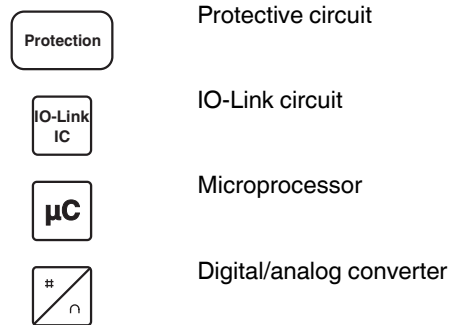

Figure 1 Internal wiring of connections

Key:



7 Pin assignment

7.1 Connections on the device

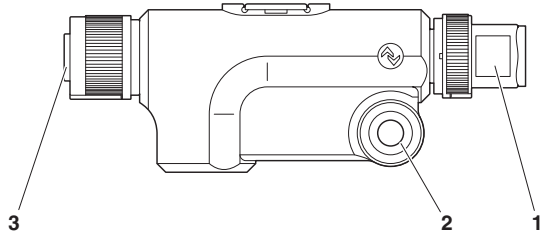

Figure 2 Connections on the converter

No.	Connection
1	IO-Link interface (indicated by IO-Link symbol)
2	Fixing options; options for connection to functional earth ground
3	Analog output

7.2 Pin assignment of the IO-Link interface

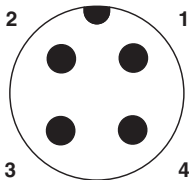

Figure 3 Pin assignment of the I/O link interface (M12 A-coded, pin)

Pin	Signal	Meaning
1	L+	+24 V supply voltage; from IO-Link master
2	-	Not used
3	L-	GND, reference potential for L+
4	C/Q	IO-Link data transmission channel

7.3 Pin assignment of the analog output

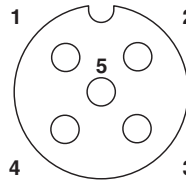

Figure 4 Pin assignment of the analog output (M12, A-coded, socket)

Pin	Assignment
1	+24 V, 100 mA
2	Not used
3	GND
4	Voltage output 0 V ... 10 V
5	Not used

8 Connection notes

Always connect the analog actuators using shielded twisted-pair cables.

9 Connection example

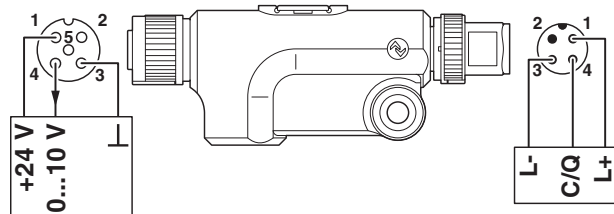

Figure 5 Connection example

10 Assembly

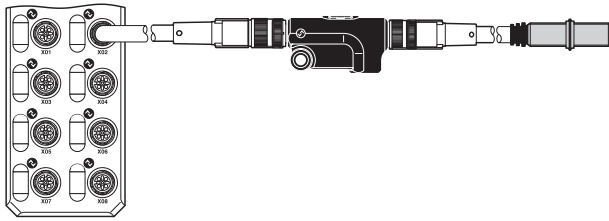

Figure 6 Connection of an actuator to an IO-Link master via the converter

- Connect the IO-Link interface of the converter to an IO-Link port of the higher-level IO-Link master using a standardized 3-pos. cable.
- Connect the analog actuator directly to the analog converter output or using a shielded 4-pos. cable.
- Fasten each connection using the M12 connectors.



In environments with high levels of interference, in particular, Phoenix Contact recommends connecting the converter to an appropriate functional earth ground point using an M4 screw.

11 Local status indicator

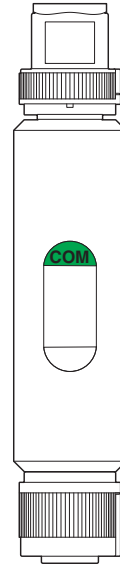

Figure 7 Local status indicator

Designation	Color	Meaning	State	Description
COM	Green	Status of IO-Link device	ON	Supply voltage OK
			Flashing	Supply voltage OK, SDCI communication active
			OFF	No supply voltage, no communication

12 Process data

The device occupies one word of IN process data and one word of OUT process data.

12.1 IN process data

The following data is transmitted in the input process data:

- During normal error-free operation, the output value is mirrored in the input process data for each channel.
- If an error occurs, the diagnostic message is mirrored in the input process data for each channel. The diagnostics message is deleted as soon as the error is eliminated.

Diagnostic messages in IB IL format

Code (hex)	Cause
8001	Overrange
8003	Short-circuit
8040	Device faulty
8080	Underrange

Diagnostic messages in S7-compatible format

Code (hex)	Cause
7FFF	Overrange
8000	Short-circuit/underrange

12.2 OUT process data

The output values are depicted in IB IL or S7-compatible format.

For both formats the output value is represented in bits 14 to 3. Bit 15 is available as a sign bit. Bits 2 to 0 are not relevant for the output value.

15	14	13	12	11	10	9	8	7	6	5	4	3	2	1	0
V	Analog value											x	x	x	

V Sign bit (= 0, not relevant)

x Not relevant for the output value (must be 0)

Parameterization

In addition, the device can be parameterized via the process data output word.

The following configurations are possible:

- Selection of formats for representing measured values
- Establishing substitute value behavior

15	14	13	12	11	10	9	8	7	6	5	4	3	2	1	0
Configuration	Reserved							Substitute value behavior in the event that IO-Link communication is aborted			Format		Reserved		



For the exact meaning of the individual bits, please refer to "Parameterization (80_{hex}: ParaWord)".



Output values in the range from 8000 ... BFFF are interpreted as parameter.

12.3 Parameterization via OUT process data

Reparameterization can be carried out via the output process data, however this is not saved permanently on the device.



Please operate the reparameterization only by the startup of the device!

The following sequence applies regardless of the format (IB IL or S7-compatible):

- The master interrupts the transmission of current process data and sends parameter data (OutputProcessData with bit 15 = 1)



In order to start configuration, bit 15 of the output word must be set to 1. If bit 15 = 0, the default configuration is active.

- The device interrupts the transmission of current process data and responds with the following diagnostic code in the process data:

Code (hex)	Cause
8800	Parameter OK
8801	Parameter ERROR

- If the diagnostic code is OK, the parameter data is accepted immediately. The master can end parameterization (OutputProcessData with bit 15 = 0). The device returns to normal operation with cyclic process data transmission.
- In the event of the ERROR diagnostic code, the master can abort parameterization without modified parameter data (OutputProcessData with bit 15 = 0) or transmit the modified parameterization (return to step 1).

12.4 Example

The example applies to the following changes:

- Selection of format S7-compatible (Default) to IB IL
- For "hold last value"

15	14	13	12	11	10	9	8	7	6	5	4	3	2	1	0	
Configuration	Reserved							Substitute value behavior in the event that IO-Link communication is aborted			Format		Reserved			
1	Reserved							1	0	1	0	Reserved				

13 Significant values in various formats

13.1 IB IL format

Resolution: 1 bit (0000 -> 0008) accords 2,67 V.

Output data		Range	0 V ... 10 V
hex	dec		V
> 7F00	> 32512	Overrange	10.837
7F00	32512	Overdrive range (End)	10.837
7538	30008	Overdrive range (Start)	10.00267
7530	30000	Nominal range (End)	10.0
3A98	15000	Nominal range	5.0
0008	8	Nominal range	0.00267
0000	0	Nominal range (Start)	0
< 0000	< 0	Underrange	0



This device cannot display voltage < 20 mV.
Values > 0020_{hex} are supported.



If overrange, input data 8001_{hex} is indicated.
If underrange, input data 8080_{hex} is indicated.
If short-circuit occurs, 0 V is issued and input data 8003_{hex} is indicated.

13.2 S7-compatible format

Resolution: 1 bit (0000 -> 0008) accords 2,89 mV.

Output data		Range	0 V ... 10 V
hex	dec		V
> 7EF8	> 32504	Overrange	0
7EF8	32504	Overdrive range (End)	11.756
6C08	27656	Overdrive range (Start)	10.00289
6C00	27648	Nominal range (End)	10.0
3600	13824	Nominal range	5.0
0008	8	Nominal range	0.00289
0000	0	Nominal range (Start)	0
< 0000	< 0	Underdrive range	0



The device cannot display voltage < 20 mV.
Values > 0018_{hex} are supported.



If overrange, input data 7FFF_{hex} is indicated.
If underrange, input data 8000_{hex} is indicated.
If short-circuit occurs, 0 V is issued and input data 8000_{hex} is indicated.

14 IO-Link objects

14.1 Overview of the objects

Index (hex)		Object name	Length in bytes	Access	Meaning	Contents
DPP	ISDU					
Identification						
07		Vendor ID	2	R	Manufacturer identification	00 _{hex}
08						B0 _{hex}
09		Device ID	3	R	Device ID	01 _{hex}
0A						00 _{hex}
0B						29 _{hex}
	10	VendorName	Max. 64	R	Manufacturer name	Phoenix Contact
	11	VendorText	Max. 64	R	Notes	www.phoenixcontact.com
	12	ProductName	Max. 64	R	Product designation	AXL E IOL AO1 U M12 S
	13	Product ID	Max. 64	R	Order No.	2700350
	14	ProductText	Max. 64	R	Product text	IO-Link/Analog-Converter Voltage Output Straight
	15	Serial number	Max. 16	R	Serial number	Stored in the production process.
	16	HardwareVersion	Max. 64	R	Hardware version	E.g., 01
	17	FirmwareVersion	Max. 64	R	Firmware version	E.g., 001
Diagnostics						
	20	Error count	2	R	Errors since power up	Number of errors
	29	OutputProcessData	2	R	Output process data	Last current data
Parameter						
	80	ParaWord	2	R/W	Parameterization	0000 _{hex}

Abbreviation	Meaning
R	Read
W	Write

14.2 Parameterization (80_{hex}: ParaWord)

Parameterize the device using this object.

In the case of valid parameters, the parameterization is permanently stored on the device.

After a reset, the device operates with the last permanently stored data. Upon delivery, the device operates with the default data (default settings).



Saving data to the device leads to a communication failure of around 30 ms.

15	14	13	12	11	10	9	8	7	6	5	4	3	2	1	0	
Reserved								Substitute value behavior in the event that IO-Link communication is aborted			Format		Reserved			

In the following tables the values in **bold** are default settings.

Format	
Code (bin)	Meaning
00	S7-compatible
10	IB IL
Other	Reserved

Substitute value behavior in the event that IO-Link communication is aborted	
Code (bin)	Meaning
00	Output of zero value (0 V) at output
01	Output of final value (10 V) at output
10	Hold last value
11	Reserved
Other	Reserved