

# PolarHT™ HiPerFET IXFH 100N25P

## Power MOSFET

N-Channel Enhancement Mode  
Fast Intrinsic Diode  
Avalanche Rated

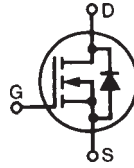

$$V_{DSS} = 250 \text{ V}$$

$$I_{D25} = 100 \text{ A}$$

$$R_{DS(on)} \leq 27 \text{ m}\Omega$$

$$t_{rr} \leq 200 \text{ ns}$$

Symbol	Test Conditions	Maximum Ratings	
$V_{DSS}$	$T_J = 25^\circ\text{C}$ to $150^\circ\text{C}$	250	V
$V_{DGR}$	$T_J = 25^\circ\text{C}$ to $150^\circ\text{C}$ ; $R_{GS} = 1 \text{ M}\Omega$	250	V
$V_{GS}$	Continuous	$\pm 20$	V
$V_{GSM}$	Transient	$\pm 30$	V
$I_{D25}$	$T_C = 25^\circ\text{C}$	100	A
$I_{D(RMS)}$	External lead current limit	75	A
$I_{DM}$	$T_C = 25^\circ\text{C}$ , pulse width limited by $T_{JM}$	250	A
$I_{AR}$	$T_C = 25^\circ\text{C}$	60	A
$E_{AR}$	$T_C = 25^\circ\text{C}$	60	mJ
$E_{AS}$	$T_C = 25^\circ\text{C}$	2.0	J
$dv/dt$	$I_S \leq I_{DM}$ , $di/dt \leq 100 \text{ A}/\mu\text{s}$ , $V_{DD} \leq V_{DSS}$ , $T_J \leq 150^\circ\text{C}$ , $R_G = 4 \Omega$	10	V/ns
$P_D$	$T_C = 25^\circ\text{C}$	600	W
$T_J$		-55 ... +150	$^\circ\text{C}$
$T_{JM}$		150	$^\circ\text{C}$
$T_{stg}$		-55 ... +150	$^\circ\text{C}$
$T_L$	1.6 mm (0.062 in.) from case for 10 s	300	$^\circ\text{C}$
$T_{SOLD}$	Plastic body for 10 s	260	$^\circ\text{C}$
$M_d$	Mounting torque	1.13/10	Nm/lb.in.
<b>Weight</b>		5.5	g

TO-247 (IXFH)

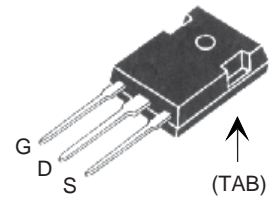

G = Gate  
S = Source  
D = Drain  
TAB = Drain

### Features

- Fast Intrinsic Diode
- International standard packages
- Unclamped Inductive Switching (UIS) rated
- Low package inductance
  - easy to drive and to protect

### Advantages

- Easy to mount
- Space savings
- High power density

Symbol	Test Conditions ( $T_J = 25^\circ\text{C}$ , unless otherwise specified)	Characteristic Values		
		Min.	Typ.	Max.
$BV_{DSS}$	$V_{GS} = 0 \text{ V}$ , $I_D = 250 \mu\text{A}$	250		V
$V_{GS(th)}$	$V_{DS} = V_{GS}$ , $I_D = 4 \text{ mA}$	2.5		5.0 V
$I_{GSS}$	$V_{GS} = \pm 20 \text{ V}_{DC}$ , $V_{DS} = 0$			$\pm 100 \text{ nA}$
$I_{DSS}$	$V_{DS} = V_{DSS}$ $V_{GS} = 0 \text{ V}$ $T_J = 125^\circ\text{C}$			25 $\mu\text{A}$ 500 $\mu\text{A}$
$R_{DS(on)}$	$V_{GS} = 10 \text{ V}$ , $I_D = 0.5 I_{D25}$ Pulse test, $t \leq 300 \mu\text{s}$ , duty cycle $d \leq 2\%$			27 $\text{m}\Omega$

Symbol	Test Conditions	Characteristic Values ( $T_J = 25^\circ\text{C}$ , unless otherwise specified)		
		Min.	Typ.	Max.
$g_{fs}$	$V_{DS} = 10\text{ V}$ ; $I_D = 0.5 I_{D25}$ , pulse test	40	56	S
$C_{iss}$	$V_{GS} = 0\text{ V}$ , $V_{DS} = 25\text{ V}$ , $f = 1\text{ MHz}$		6300	pF
$C_{oss}$			1150	pF
$C_{rss}$			240	pF
$t_{d(on)}$	$V_{GS} = 10\text{ V}$ , $V_{DS} = 0.5 V_{DSS}$ , $I_D = I_{D25}$ $R_G = 3.3\ \Omega$ (External)		25	ns
$t_r$			26	ns
$t_{d(off)}$			100	ns
$t_f$			28	ns
$Q_{g(on)}$	$V_{GS} = 10\text{ V}$ , $V_{DS} = 0.5 V_{DSS}$ , $I_D = 0.5 I_{D25}$		185	nC
$Q_{gs}$			43	nC
$Q_{gd}$			91	nC
$R_{thJC}$			0.21	$^\circ\text{C/W}$
$R_{thCS}$		0.25		$^\circ\text{C/W}$

Symbol	Test Conditions	Characteristic Values ( $T_J = 25^\circ\text{C}$ , unless otherwise specified)		
		Min.	Typ.	Max.
$I_s$	$V_{GS} = 0\text{ V}$			100 A
$I_{SM}$	Repetitive			250 A
$V_{SD}$	$I_F = I_s$ , $V_{GS} = 0\text{ V}$ , Pulse test, $t \leq 300\ \mu\text{s}$ , duty cycle $d \leq 2\%$			1.5 V
$t_{rr}$	$I_F = 25\text{ A}$ , $-di/dt = 100\text{ A}/\mu\text{s}$ $V_R = 100\text{ V}$			200 ns
$Q_{RM}$			0.6	$\mu\text{C}$
$I_{RM}$			10	A

### TO-247 (IXFH) Outline

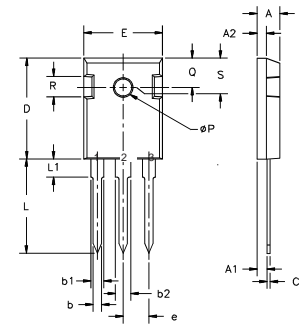

Terminals: 1 - Gate  
2 - Drain  
3 - Source  
Tab - Drain

Dim.	Millimeter		Inches	
	Min.	Max.	Min.	Max.
A	4.7	5.3	.185	.209
A <sub>1</sub>	2.2	2.54	.087	.102
A <sub>2</sub>	2.2	2.6	.059	.098
b	1.0	1.4	.040	.055
b <sub>1</sub>	1.65	2.13	.065	.084
b <sub>2</sub>	2.87	3.12	.113	.123
C	.4	.8	.016	.031
D	20.80	21.46	.819	.845
E	15.75	16.26	.610	.640
e	5.20	5.72	0.205	0.225
L	19.81	20.32	.780	.800
L1		4.50		.177
ØP	3.55	3.65	.140	.144
Q	5.89	6.40	0.232	0.252
R	4.32	5.49	.170	.216
S	6.15	BSC	242	BSC

IXYS reserves the right to change limits, test conditions, and dimensions.

IXYS MOSFETs and IGBTs are covered by 4,835,592 4,931,844 5,049,961 5,237,481 6,162,665 6,404,065 B1 6,683,344 6,727,585  
one or more of the following U.S. patents: 4,850,072 5,017,508 5,063,307 5,381,025 6,259,123 B1 6,534,343 6,710,405B2 6,759,692  
4,881,106 5,034,796 5,187,117 5,486,715 6,306,728 B1 6,583,505 6,710,463 6,771,478 B2

**Fig. 1. Output Characteristics @ 25°C**

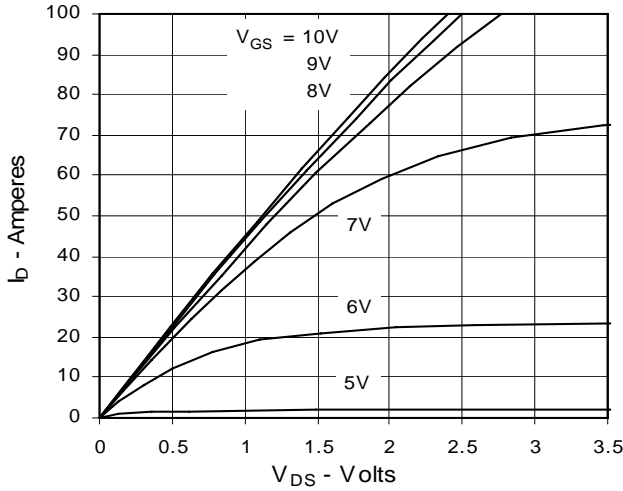

**Fig. 2. Extended Output Characteristics @ 25°C**

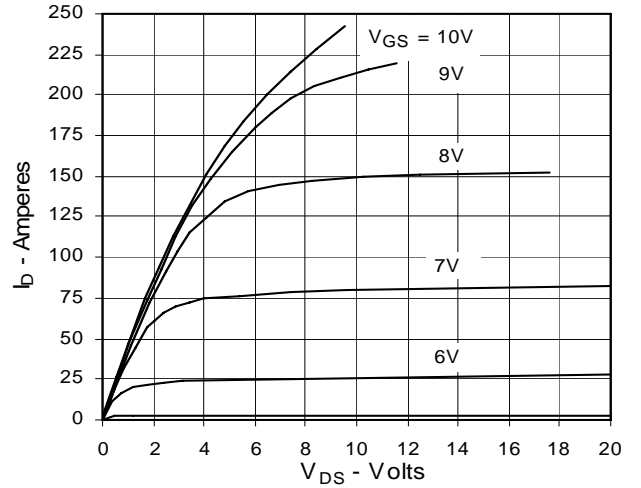

**Fig. 3. Output Characteristics @ 125°C**

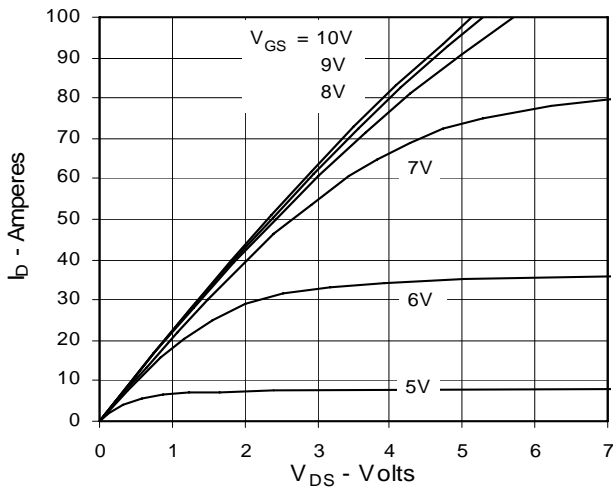

**Fig. 4.  $R_{DS(on)}$  Normalized to 0.5  $I_{D25}$  Value vs. Junction Temperature**

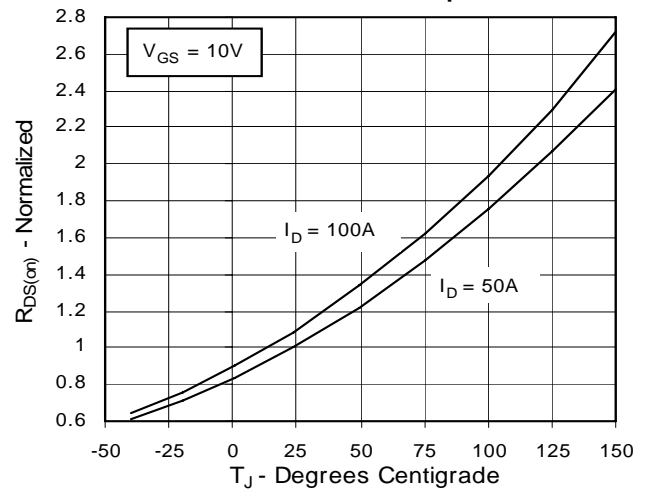

**Fig. 5.  $R_{DS(on)}$  Normalized to 0.5  $I_{D25}$  Value vs.  $I_D$**

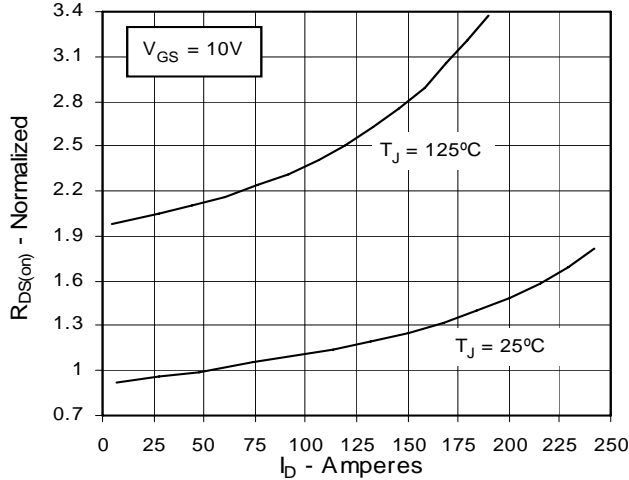

**Fig. 6. Drain Current vs. Case Temperature**

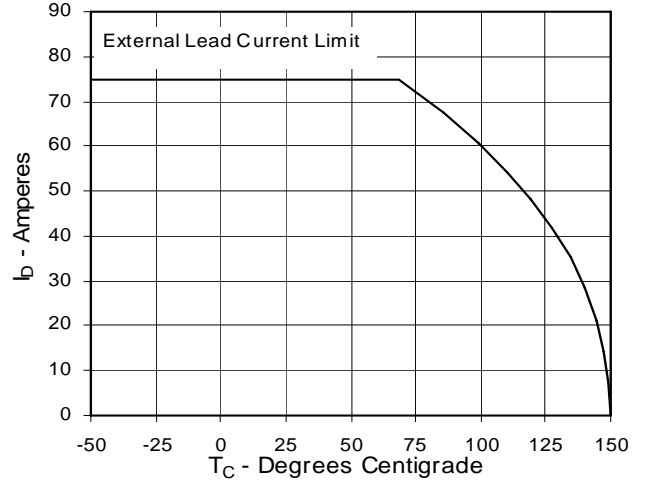

**Fig. 7. Input Admittance**

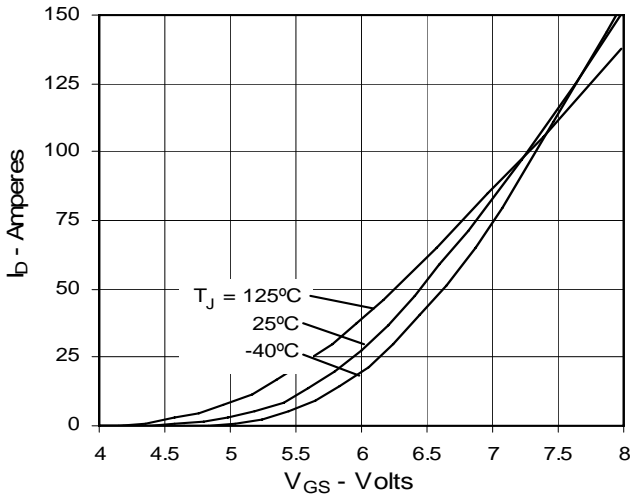

**Fig. 8. Transconductance**

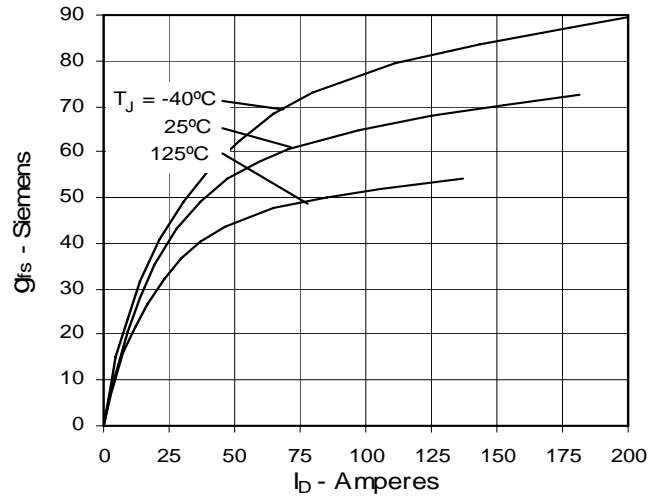

**Fig. 9. Source Current vs. Source-To-Drain Voltage**

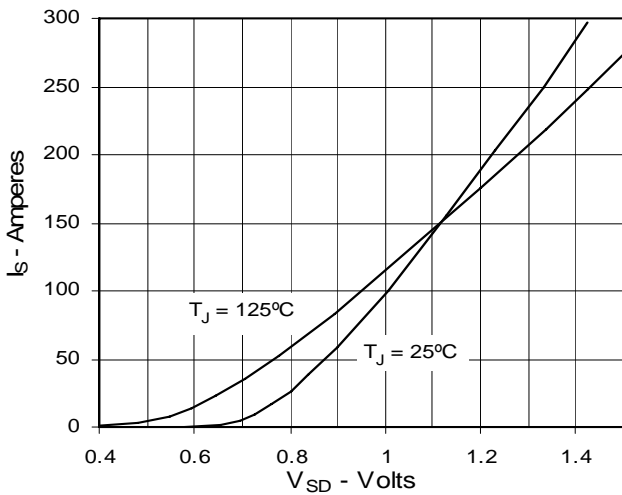

**Fig. 10. Gate Charge**

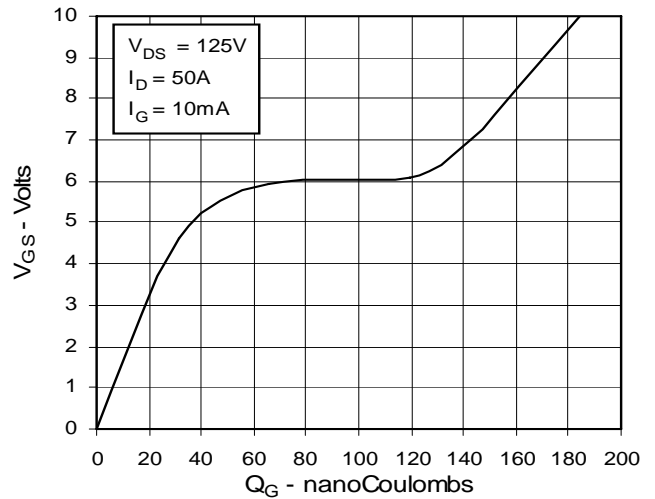

**Fig. 11. Capacitance**

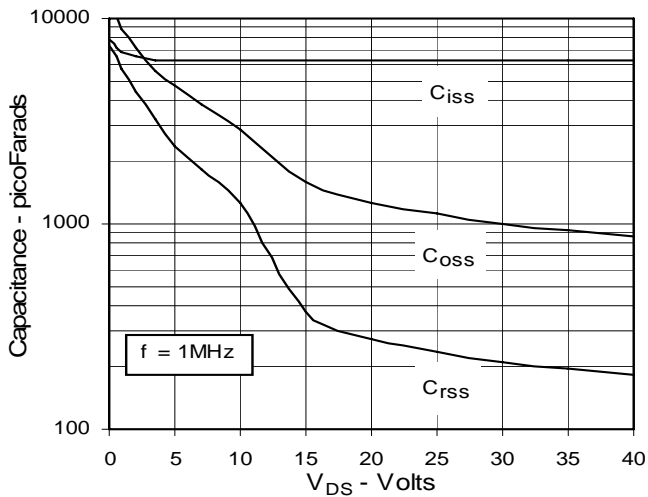

**Fig. 12. Forward-Bias Safe Operating Area**

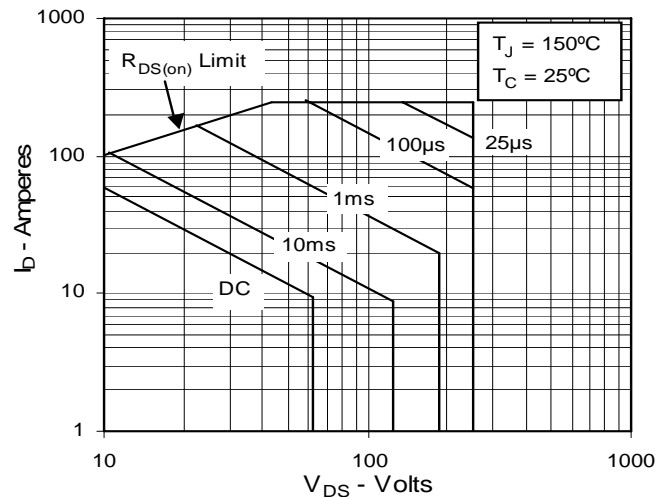

Fig. 13. Maximum Transient Thermal Resistance

