

## Pin strip - PST 1,0/ 2-3,5 R24 - 1720233

Please be informed that the data shown in this PDF Document is generated from our Online Catalog. Please find the complete data in the user's documentation. Our General Terms of Use for Downloads are valid (<http://phoenixcontact.com/download>)



Header, Nominal current: 8 A, Rated voltage (III/2): 250 V, Number of positions: 2, Pitch: 3.5 mm, Color: black, Contact surface: Tin, Assembly: Taped SMD/THT/THR components, Voltage and current depend on the plug-in terminal block used.

### Product Features

- Pin strip with pad pushed on for suction pipette for optional tape-on-reel packing
- Various pin lengths and pin geometries available on request
- 3.5 mm pitch
- Pin strip available in machine-capable packaging (tube magazine or tape)
- Optimum pin geometry so as to not damage the plug
- Reflow solderable pin strip, optimized for COMBICON compact connectors



### Key commercial data

Packing unit	1 pc
Minimum order quantity	330 pc
Weight per Piece (excluding packing)	1.47 GRM
Custom tariff number	85366990
Country of origin	Germany

### Technical data

#### Dimensions

Length	2.8 mm
Pitch	3.5 mm
Dimension a	3.5 mm
Pin dimensions	1 mm
Pin spacing	3.50 mm
Hole diameter	1.2 mm

#### General

## Pin strip - PST 1,0/ 2-3,5 R24 - 1720233

### Technical data

#### General

Range of articles	PST 1,0/...-V
Insulating material group	IIIa
Rated surge voltage (III/3)	2.5 kV
Rated surge voltage (III/2)	2.5 kV
Rated surge voltage (II/2)	2.5 kV
Rated voltage (III/3)	160 V
Rated voltage (III/2)	250 V
Rated voltage (II/2)	250 V
Connection in acc. with standard	EN-VDE
Nominal current I <sub>N</sub>	8 A (depends on the plug used)
Maximum load current	8 A (depends on the plug used)
Insulating material	PA
Inflammability class according to UL 94	V0
Color	black
Number of positions	2

### Classifications

#### eCl@ss

eCl@ss 4.0	272607xx
eCl@ss 4.1	27260701
eCl@ss 5.0	27260701
eCl@ss 5.1	27260701
eCl@ss 6.0	27260704
eCl@ss 7.0	27440402
eCl@ss 8.0	27440402

#### ETIM

ETIM 3.0	EC001121
ETIM 4.0	EC002637
ETIM 5.0	EC002637

#### UNSPSC

UNSPSC 6.01	30211801
UNSPSC 7.0901	39121432
UNSPSC 11	34131203
UNSPSC 12.01	39121432
UNSPSC 13.2	39121432

# Pin strip - PST 1,0/ 2-3,5 R24 - 1720233

## Approvals

### Approvals

---

#### Approvals

UL Recognized / cUL Recognized / GOST / GOST / SEV / cULus Recognized

---

#### Ex Approvals

---

#### Approvals submitted

---

### Approval details

UL Recognized 	
	B
Nominal current IN	10 A
Nominal voltage UN	300 V

cUL Recognized 	
	B
Nominal current IN	10 A
Nominal voltage UN	300 V

GOST 	
--	--

GOST 	
--	--

SEV	
mm <sup>2</sup> /AWG/kcmil	0.5

# Pin strip - PST 1,0/ 2-3,5 R24 - 1720233

## Approvals

Nominal current I <sub>N</sub>	4 A
Nominal voltage U <sub>N</sub>	160 V

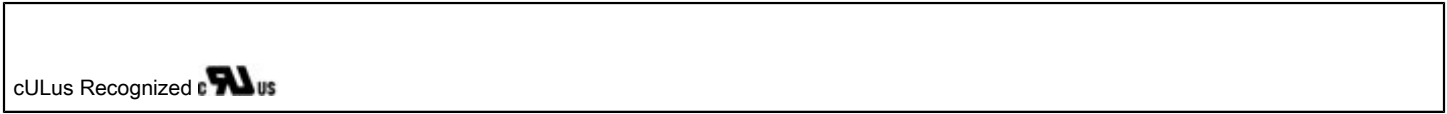

## Drawings

Drilling diagram

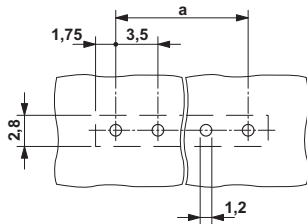

Dimensioned drawing

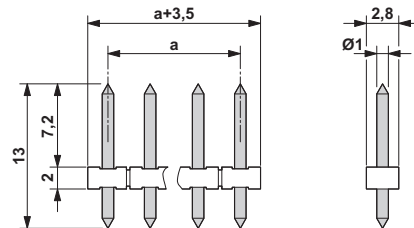

Dimensioned drawing

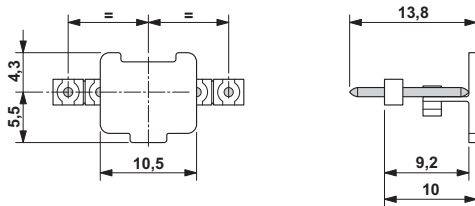

Dimensioned drawing

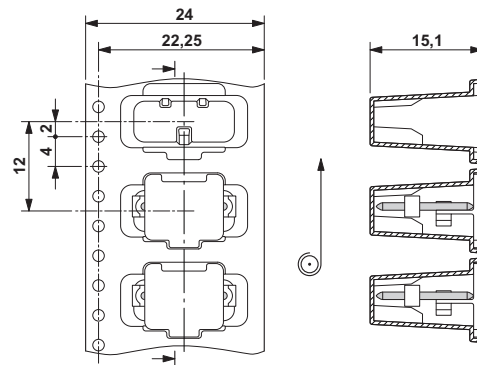

Pad position for PST 1,0/...-3,5 R...