



## AD8450/ADP1972 Battery Testing and Formation Evaluation Board

### FEATURES

Fully functional Li-Ion cell formation and testing similar to real-world manufacturing equipment

Ability to charge and discharge batteries under constant current (CC) and constant voltage (CV) control

Energy recycling from discharging battery into dc bus

Full featured system evaluation board based on the [AD8450](#) and [ADP1972](#)

PC software for control and monitoring of system parameters

Compatible with the system demonstration platform, SDP-S ([EVAL-SDP-CS1Z](#))

### EQUIPMENT NEEDED

Bench power supply, 12 V dc (current depending on desired battery charge rate)

Test battery

### EVALUATION KIT CONTENTS

Analog control board

Power stage board

SDP-S board for data transfer to PC

Standard USB A to Mini-B USB cable

Printed user guide

Evaluation kit software CD

Business card with Analog Devices, Inc., website address for software and documentation

### HARDWARE REQUIREMENTS

Bench power supply, 12 V dc (current depending on desired battery charge rate)

Test battery or electronic load

PC running Windows 7

### WARNING

When testing this system with lithium-ion (Li-Ion) batteries, take care not to overcharge or overdischarge the batteries, or to sink/source more than the maximum current recommended by the manufacturer of the battery. Exceeding these ratings not only damages the battery, but can also cause it to explode or catch fire.

### GENERAL DESCRIPTION

The [AD8450-EVALZ/ADP1972-EVALZ](#) evaluation kit is a good starting point for users building battery formation and test equipment based on the Analog Devices [AD8450](#) precision analog front end and controller and the [ADP1972](#) buck or boost pulse-width modulation (PWM) controller. The system includes an analog control board and a power stage board.

In addition to the [AD8450](#) and [ADP1972](#), the analog control board also includes an [AD5689R](#) 16-bit, precision digital-to-analog converter (DAC) to set the current and voltage set points, and an [AD7173-8](#) 24-bit,  $\Sigma$ - $\Delta$  analog-to-digital converter (ADC) to monitor the battery voltage and current.

The board includes built-in voltage regulators so that it can be powered either from the power stage board or directly from a 12 V dc through a screw terminal connector.

The analog control board connects to the Analog Devices system demonstration platform—serial (SDP-S) board through a 120-pin connector. The SDP-S board connects to the user interface software through the USB port, allowing the user to set the current and voltage set point as well as the mode of operation (charge/discharge). In addition, the user can monitor the battery voltage and current by reading the data output from the [AD7173-8](#).

The analog control board connects to the power stage board through a 32-pin header. This modular approach allows the user to design and test their own power stage boards, designed for the current output range in their end applications, with the analog control board of this reference design.

The power stage board supports charge and discharge currents of up to 20 A. It includes the power MOSFETs, inductor, and input and output capacitors required to implement a buck or boost regulator, depending on the operating mode.

Full specifications on the [ADP1972](#) and [AD8450](#) are available in the product data sheets, which should be consulted in conjunction with this user guide when working with the evaluation kit.

The [AD8451](#) can also be installed in the [AD8450](#) socket with minimal changes.

**TABLE OF CONTENTS**

Features .....	1	Evaluation Board Software.....	7
Equipment Needed.....	1	Installing the Software .....	7
Evaluation Kit Contents.....	1	Installation Steps .....	7
Hardware Requirements .....	1	Board Operation and Connection Sequence .....	8
Warning .....	1	Running the Software with the Hardware Connected .....	9
General Description .....	1	Software Operation .....	10
Revision History .....	2	Description of Main Window.....	10
Simplified Evaluation Board Block Diagram.....	3	Configuration Tab.....	11
Evaluation Board Photograph.....	4	Evaluation Board Schematics—Power Stage Board.....	13
Evaluation Board Hardware.....	5	Evaluation Board Schematics—Analog Control Board .....	19
Setting Up the Evaluation System .....	5	Troubleshooting.....	32
Powering the System .....	5	Software .....	32
AD8450 Compensation Networks .....	5	Hardware .....	32
Serial Interface .....	5	Products on this Evaluation System.....	33
Power Stage Board Description .....	6	Related Links.....	33
Analog Control Board Description.....	6		

**REVISION HISTORY**

5/16—Revision 0: Initial Version

### SIMPLIFIED EVALUATION BOARD BLOCK DIAGRAM

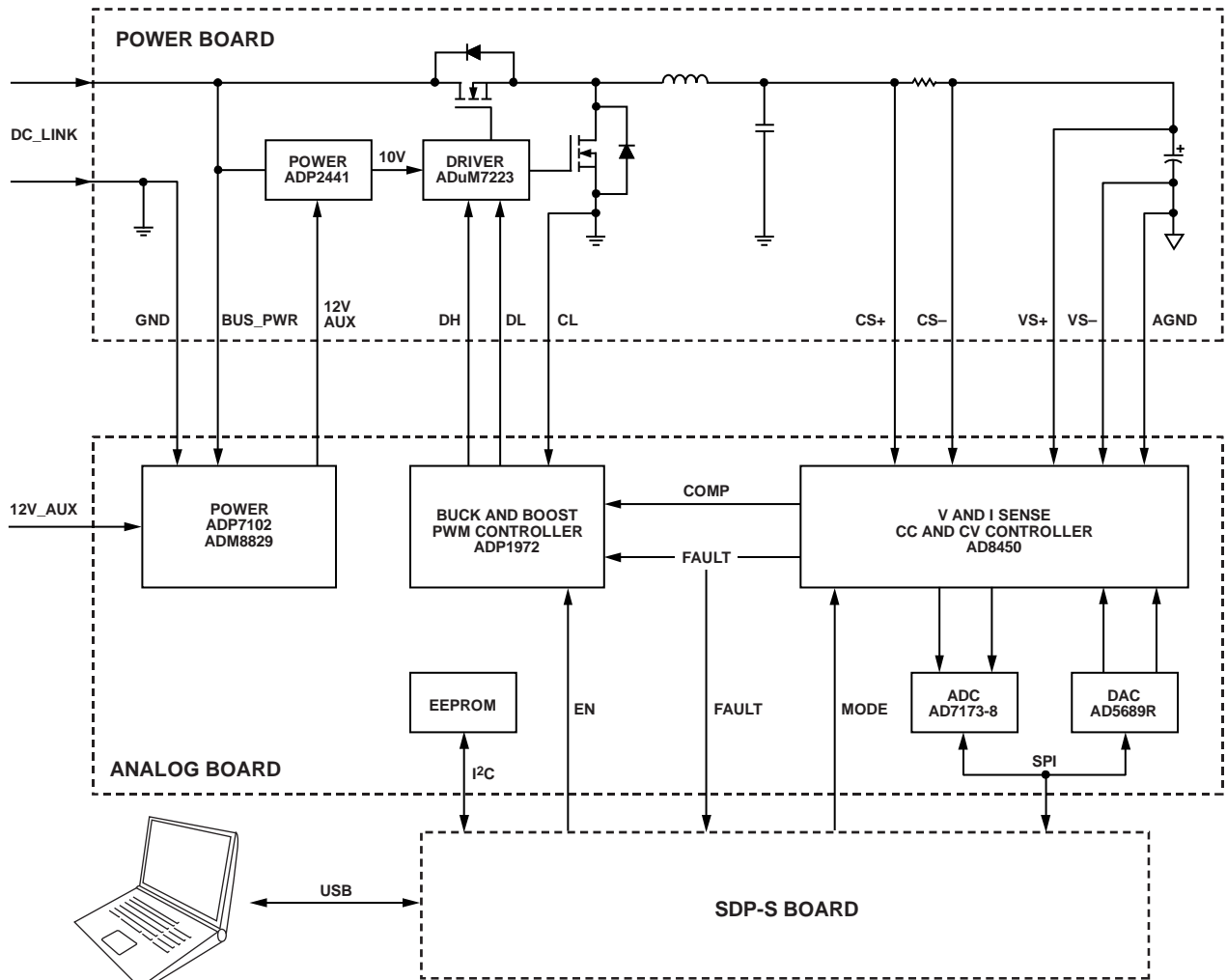

Figure 1.

13289-002

# EVALUATION BOARD PHOTOGRAPH

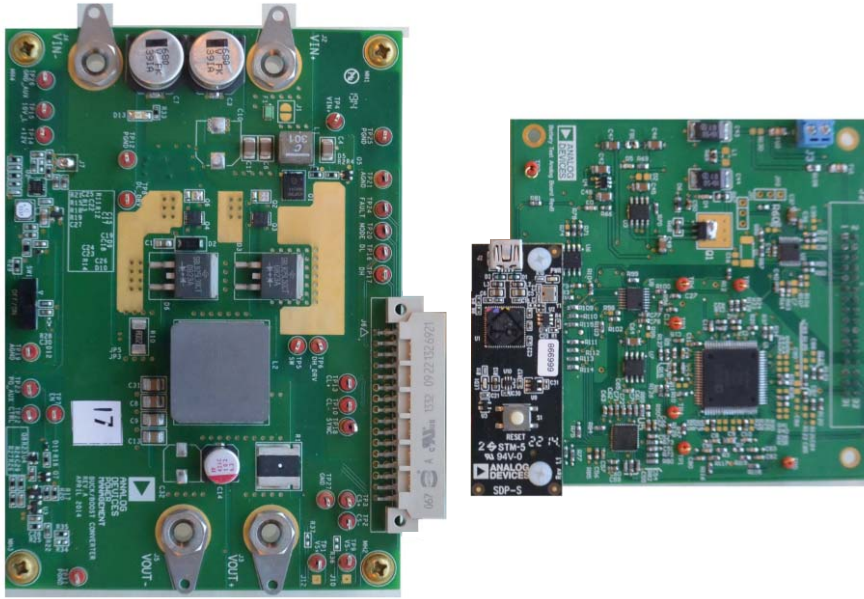

Figure 2. Power Stage Board (Left) and Analog Control Board with SDP-5 Attached (Right)

1326B-001

## EVALUATION BOARD HARDWARE

### SETTING UP THE EVALUATION SYSTEM

Figure 26 to Figure 29 show the analog control board schematic, and Figure 17 shows the power stage board schematic.

The analog control board includes the [AD8450](#) (U1), the [ADP1972](#) (U2), the [AD7173-8](#) 24-bit  $\Sigma$ - $\Delta$  ADC (U5), and the [AD5689R](#) 16-bit DAC (U8).

The 32-pin header connector mates with the power stage board and includes the PWM control signals for the MOSFET drivers, as well as the battery voltage, the current signals, and the supply voltage for the analog control board. The modular approach of the system allows users to use the analog control board with their custom design power stage. Table 1 lists the header pin names and functionalities.

The power stage board includes an [ADuM7223](#) MOSFET driver (U1), an [ADP2441](#) buck regulator (U2) to power the MOSFET driver, a high-side and low-side power MOSFET, parallel Schottky diodes, and input/output capacitors.

Connect the boards as shown in Figure 2.

### POWERING THE SYSTEM

The evaluation system requires power from an external dc power source. The nominal input voltage is 12 V, connected through the banana input terminals labeled J2 and J4 on the power stage board. The input current depends on the desired load current (that is, battery charge current). To run the board at the rated 20 A charge current into a 5 V load, the input 12 V power supply must be capable of delivering at least 9.5 A.

The analog control board receives power through the 32-pin connector. However, this board also includes the J3 screw terminal connector, if the user wants to power the board separately. To power the analog control board independently of the power stage board, remove Resistor R108 and populate a 0  $\Omega$  jumper at R130.

To turn on the board, apply power as described previously and move Switch SW1 on the power stage board to the on position.

### AD8450 COMPENSATION NETWORKS

The evaluation system ships configured for connection to a Chroma 63600 series electronic load. If the electronic load of the user has a different response, or if the user wants to use the system with a rechargeable battery, adjust the compensation values in each of the four [AD8450/AD8451](#) control loops to ensure system stability. Use the online [AD8450/AD8451](#) compensator design tool at <http://analogplayground.com/AD8450>, and see the [AN-1319](#) for detailed analysis.

### SERIAL INTERFACE

The evaluation system uses the SPI interface on the SDP-S board to read the current and voltage ADCs, and to set the current and voltage set points with the [AD5689R](#) DAC.

**Table 1. 32-Pin Board to Board Connector Pinout**

Pin No.	Name	Description
1	BUS_PWR	Supply rail from power stage board
2, 11 to 16, 18, 19, 20 to 24	DGND	Digital ground
3	+12V	Supply rail to power stage board
4	DH	High-side driver signal
5	DL	Low-side driver signal
6	MODE	Selects between charge/discharge mode
7	EN_PWR	Enable signal for power stage
8	Fault	Fault detection from <a href="#">ADP1972</a>
9	CL	Current-limit sense line to <a href="#">ADP1972</a>
10	CL_SENSE	Current-limit ground sense line to <a href="#">ADP1972</a>
17	SYNC_PWR	Sync pin to and from <a href="#">ADP1972</a>
33 to 36	AGND	Analog ground
37	CS+	Sense line from current sense resistor
38	CS-	Sense line from current sense resistor
39	VS+	Sense line from battery positive (+) terminal
40	VS-	Sense line from battery negative (-) terminal

## POWER STAGE BOARD DESCRIPTION

Figure 17 shows the power stage board schematic. The bench power supply connects to the power stage board through the J2 (+) and J4 (–) banana jacks. The J3 (+) and J4 (–) banana jacks are the regulated charge/discharge terminals, and connect to an electronic load or battery.

The power stage includes input capacitors, a low-side and high-side MOSFET, an inductor, and output capacitors. Depending on the mode of operation, the ADP1972 drives the power stage either in step-down (buck) or step-up (boost) mode. The board includes pads for up to two parallel MOSFETs and up to two parallel dual diodes. The ADP1972 drives the power stage in nonsynchronous mode. Therefore, having external, low forward voltage diodes in parallel with the MOSFETs is very important for operation at high efficiency.

The power stage board includes a 2 mΩ sense resistor (R1) for measuring the output current to the electronic load or battery.

The ADuM7223 translates the 5 V level PWM signals from the ADP1972 into low impedance, 10 V drive signals for the MOSFETs. An auxiliary step-down regulator based on the ADP2441 generates the 10 V rail for the MOSFET driver from the main input rail.

## ANALOG CONTROL BOARD DESCRIPTION

The analog control board includes the ADP1972, the AD8450/AD8451, a DAC to configure the set points, and an ADC to monitor the current and voltage.

The analog control board includes an ADP7102 linear regulator to generate 5 V, and an ADM8829 switched capacitor inverter that generates –5 V for the AD8450/AD8451 so that it can measure and output voltages close to 0 V.

The current sense programmable gain instrumentation amplifier (PGIA) of the AD8450 is configured for a gain of 66 by populating R18 and R29. Table 2 shows how to configure the board to achieve other gains. With a gain of 66, a 20 A output current results in an output voltage of 2.64 V at TP4 (ISMEA pin).

The voltage sense programmable gain differential amplifier (PGDA) is configured for a gain of 0.8 by populating R41 and R42. Table 3 shows how to configure the board for other possible gains. With a gain of 0.8, a 5 V battery voltage results in a 4 V output at TP1 (BVMEA pin).

**Table 2. PGIA Gain Configuration**

Gain	Resistors with 0 Ω jumpers
26	R19, R30
66	R18, R29
133	R17, R28
200	R16, R27

**Table 3. PGDA Gain Configuration**

Gain	Resistors with 0 Ω jumpers
0.8	R41, R42
0.4	R40, R43
0.27	R39, R44
0.2	R38, R45

The AD7173-8 ADC measures the voltage and current signals and reports the values to the user interface software through the SDP-S interface. The full-scale input range of the AD7173-8 is 5 V. The AD5689R DAC Output A configures the constant current setpoint, and Output B sets the constant voltage setpoint. The DAC output range is also from 0 V to 5 V. Given the current and voltage gain settings of the AD8450/AD8451, the current and voltage setpoints can be calculated as follows:

$$\text{Constant\_Current\_Setpoint} = V_{\text{DAC\_A}} / (\text{PGIA\_GAIN} \times 0.003)$$

$$\text{Constant\_Current\_Setpoint} = V_{\text{DAC\_B}} / (\text{PGDA\_GAIN})$$

## EVALUATION BOARD SOFTWARE

### INSTALLING THE SOFTWARE

The evaluation board software can be downloaded from the [AD8450](#), [AD8451](#), and [ADP1972](#) product pages on the Analog Devices website at [www.analog.com](http://www.analog.com).

Install the software prior to connecting the SDP-S board to the USB port of the PC to ensure that the SDP-S board is recognized when it connects to the PC.

1. Start the Windows® operating system and download the software from the relevant product page on the Analog Devices website at [www.analog.com](http://www.analog.com).
2. Unzip the downloaded file. Run the **setup.exe** file.
3. After installation is completed, plug the SDP-S board into the PC using a USB cable, and power up the evaluation board as described in the Powering the System section.
4. Launch the software.
5. When the software detects the evaluation board, proceed through any dialog boxes that appear to finalize the installation.

The default location for the software is **C:\Program Files (x86)\Analog Devices\AD8450-ADP1972\_SystemDemo**.

This location contains the executable software and support files.

### INSTALLATION STEPS

Proceed through the installation, allowing the software and drivers to be placed in the appropriate locations. Connect the SDP-S board to the PC only after the software and drivers have been installed.

There are two sequences to the software installation. The first sequence installs the software related to the evaluation board, as shown in Figure 3 to Figure 6.

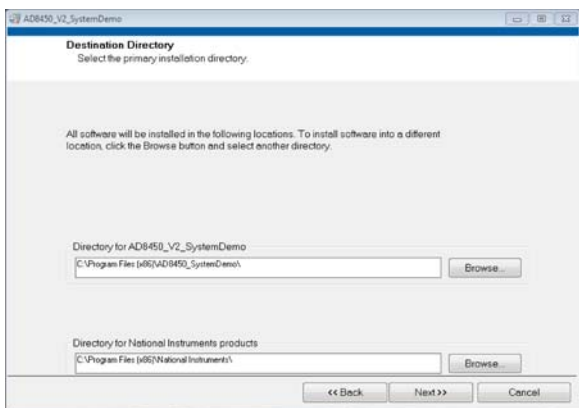

Figure 3. Choose Folder Location (Default Folder Shown)

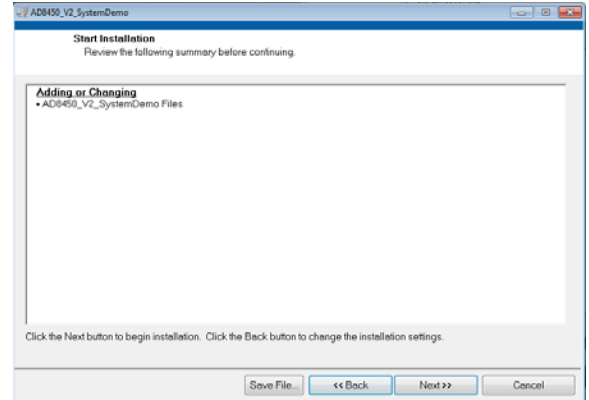

Figure 4. Click **Next >>** to Install Software

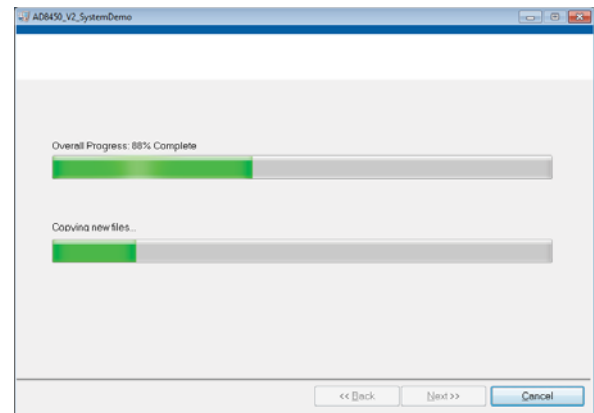

Figure 5. Bar Showing Installation Progress

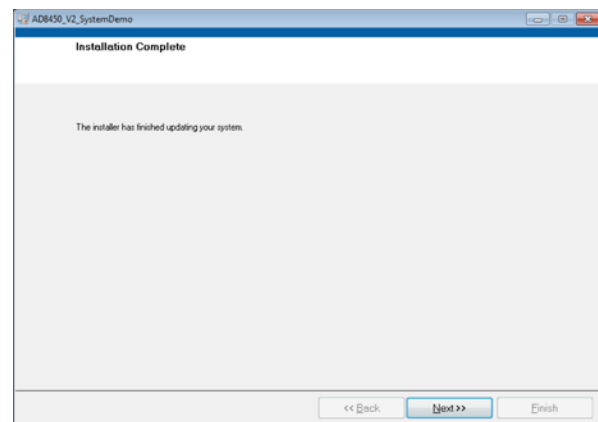

Figure 6. Installation Complete, Click **Next >>** to Finish

The second sequence of the software installation installs the system demonstration platform (SDP) drivers for the SDP-S board (see Figure 7 to Figure 10). These drivers must be installed for the evaluation board to function correctly.

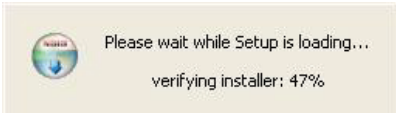

Figure 7. Installation for SDP Drivers Starting



Figure 8. Click **Next >** to Install the SDP Drivers

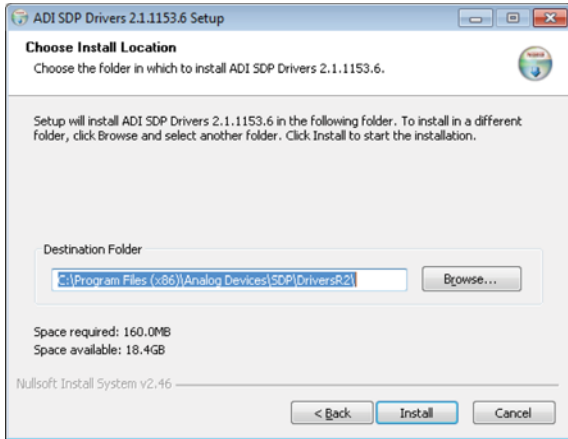

Figure 9. Choose Install Location (Default Folder Shown)

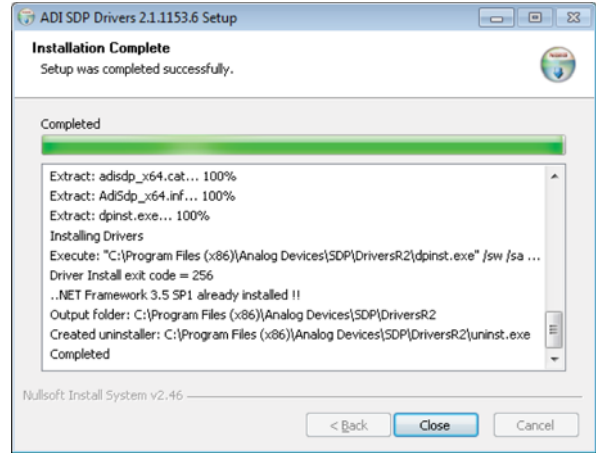

Figure 10. Click **Close** to Complete Installation

When the SDP-S board is first plugged into the PC via the USB cable provided, allow the new **Found Hardware Wizard** to run. Check that the drivers and the board are connected correctly by looking at the **Device Manager** of the PC. If connected correctly, the **Analog Devices System Development Platform SDP-S** appears under **ADI Development Tools** (see Figure 11).



Figure 11. Device Manager

**BOARD OPERATION AND CONNECTION SEQUENCE**

The following is the board operation and connection sequence:

1. Connect the SDP-S controller board to the evaluation board with the J4 connector (screw into place as required).
2. Power the board with appropriate supply as described in the Powering the System section.
3. Connect an electronic load or battery.
4. Connect the board to the PC with the USB cable.
5. To launch the software, click **Start > All Programs > Analog Devices > AD8450 System Demo > AD8450-ADP1972 Demo**.
6. Configure the set points and use the software to monitor the battery state.



## RUNNING THE SOFTWARE WITH THE HARDWARE CONNECTED

To run the program, take the following steps:

1. Click **Start > All Programs > Analog Devices > AD8450 System Demo > AD8450-ADP1972 Demo**.
2. If the SDP-S board is not connected to the USB port when the software is launched, a connectivity error displays (see Figure 12). Connect the evaluation board to the USB port of the PC, wait a few seconds until the board appears in the lower section of the window, and click **Select** (see Figure 12).

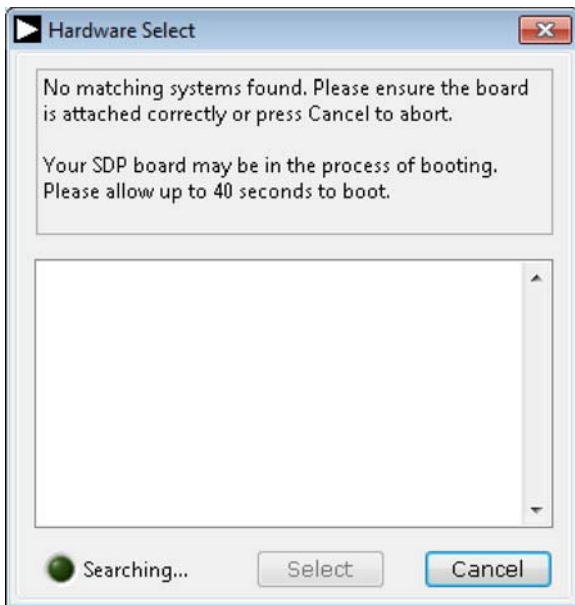

Figure 12. SDP-S Board Not Connected to the USB Port

3. When the evaluation board is detected, the message in Figure 13 displays. Click **Select** to continue.

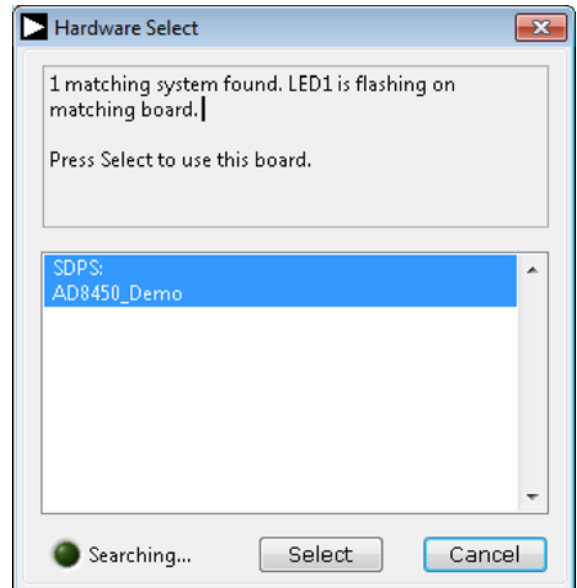

Figure 13. Software Detects Evaluation Board

4. The software then connects to the board, and the software window opens.

## SOFTWARE OPERATION

When the software launches, the window shown in Figure 14 opens and the software begins communicating with the analog control board. The software starts with the power stage disabled, which allows the user to configure the setpoints before any current flows into the load.

### DESCRIPTION OF MAIN WINDOW

The main window shows the system status at a glance. The system diagram quickly shows whether the system is set to either charge or discharge mode, and the digital indicators next to the battery icon and the current icon show the readings for battery voltage and current.

The **POWER STAGE OFF** button indicates that the system is disabled. Clicking this button enables the power stage (and the button changes to **POWER STAGE ON**). Similarly, the **MODE: CHARGE** button indicates that the system is currently in charge

mode. Clicking this button changes the power stage configuration (the button changes to **MODE: DISCHARGE**).

The **Amp-Hours** indicator is a simple integrator. It takes the battery current measurement every 100 ms, calculates the equivalent amp-hour value, and accumulates the result with the previous result. This allows the system to measure battery capacity from the time the battery is enabled until it is fully charged/discharged, or until the mode setting is changed.

To change the constant current or constant voltage setpoint values, type the new value into the corresponding field, in units of amps or volts, respectively, and press the Enter key.

The time data chart shows a strip chart of current and voltage as the battery charges or discharges.

Figure 15 shows the main window in constant current, discharge mode.

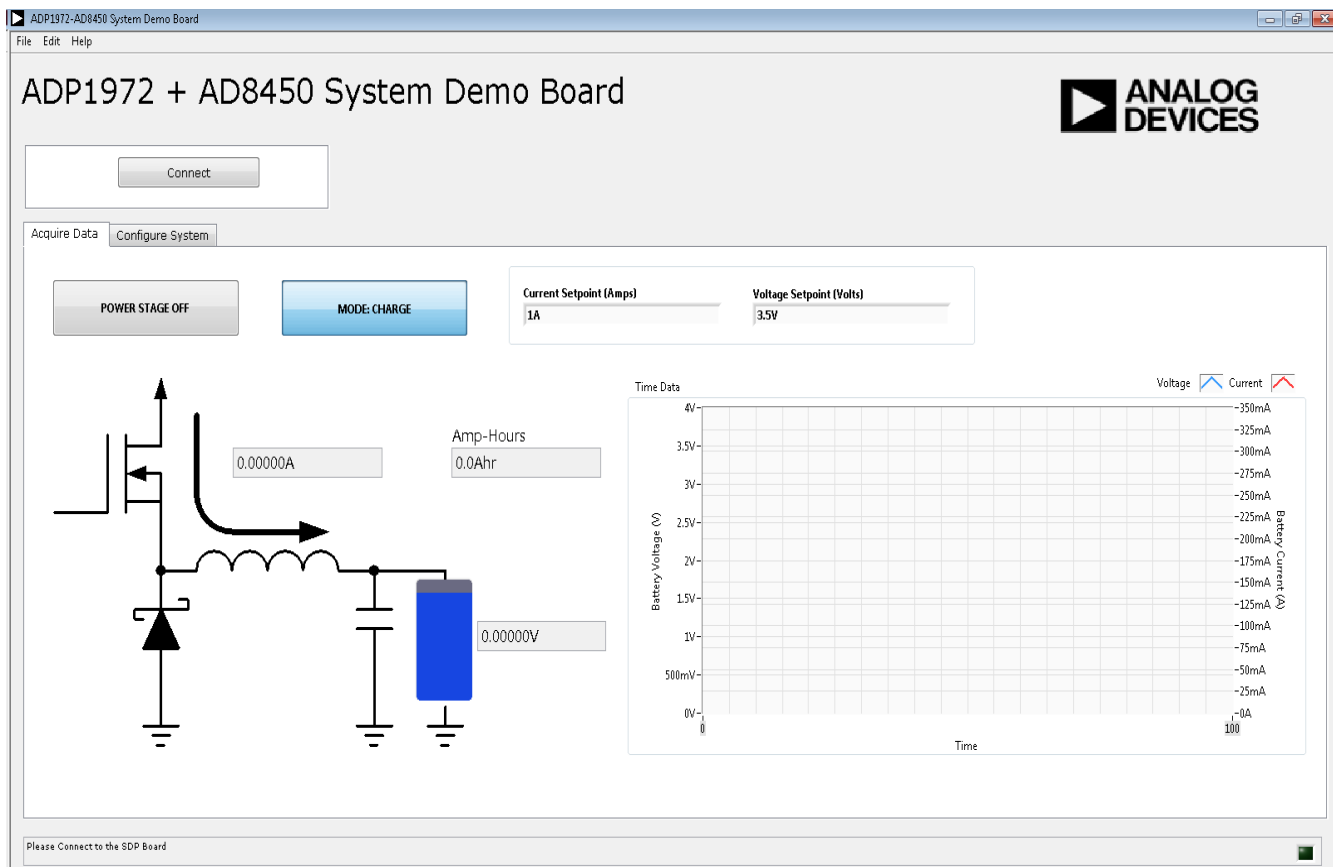

Figure 14. ADP1972 + AD8450 System Demo Software Main Window

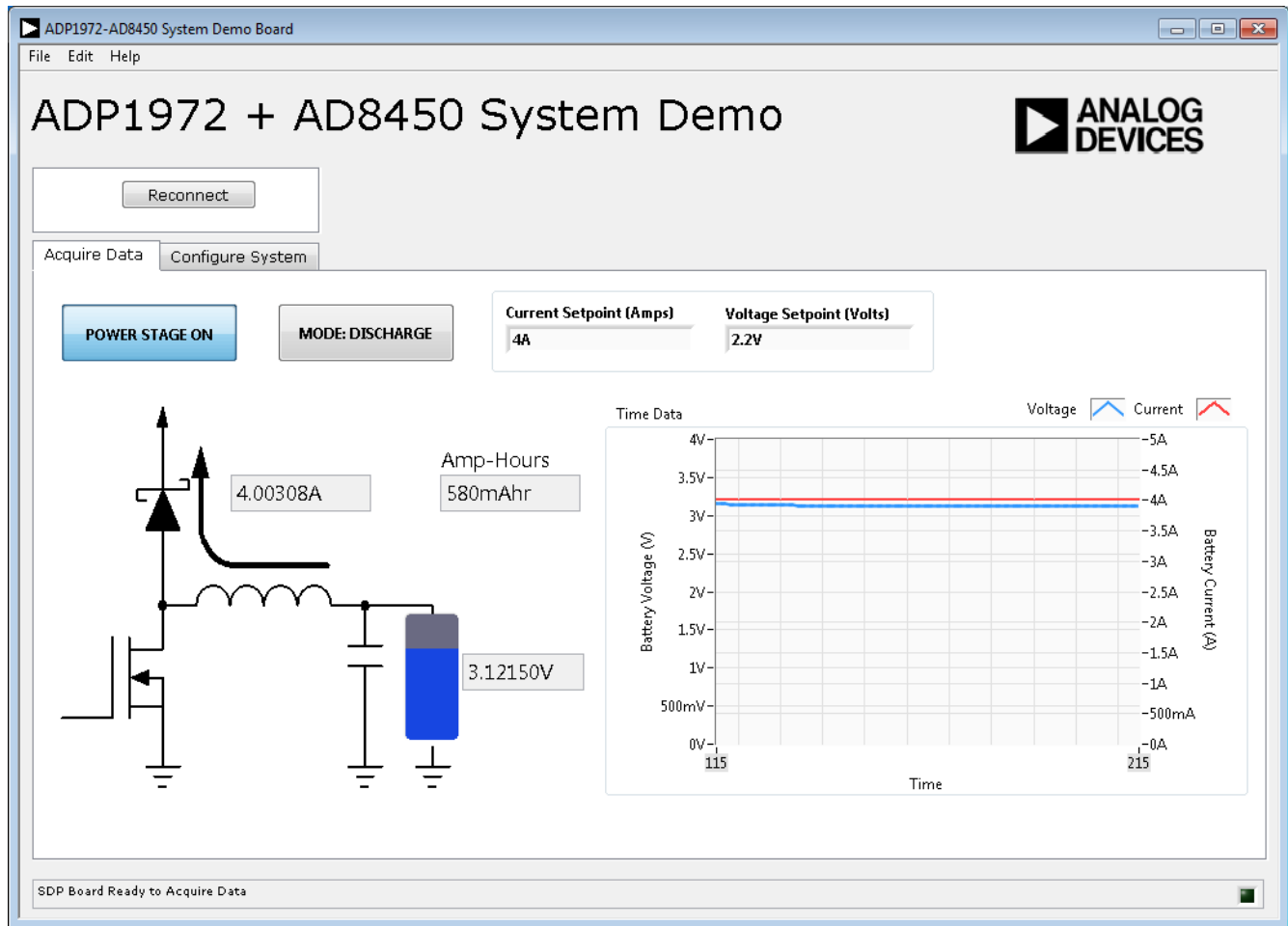

Figure 15. Software Main Window During Normal Operation

## CONFIGURATION TAB

Click **Configure System** to open the configuration tab (see Figure 16). This tab contains several options described in the following sections.

### Sample Timing Controls

**Sample Interval** sets the rate at which the system updates the battery voltage and current measurements. The sample interval is the rate at which the screen updates, and is completely independent of the analog control loop.

**Graphing Sampling Rate Multiple** sets the update rate for the main window as a ratio of the sample interval. For example, setting the **Sample Interval** to 1 sec and the **Graphing Sample Rate Multiple** to 1 results in chart updates every second. Setting the **Graphing Sampling Rate Multiple** to 5 results in graph updates only every 5 sec.

### Calibration Controls

The gain correction and offset controls allow the user to perform system level calibration. The measurements displayed in the main window are the nominal output from the ADC scaled with the equation

$$\text{Output Measurement} = (\text{Nominally Scaled Measurement} - \text{Offset Correction}) \times \text{Gain Correction}$$

where *Nominally Scaled Measurement* uses the typical values for the sense resistor, the ADC reference, the [AD8450](#) gain, and so on.

The calibration controls, shown in Figure 16, are as follows.

**Current Gain Correction** is the gain correction constant for the current measurement. The default is 1.

**Current Offset (A)** is the offset correction constant for the current channel, in units of amps. The default is 0.

**Voltage Gain Correction** is the gain correction constant for the voltage measurement. The default is 1.

**Voltage Offset (V)** is the offset correction constant for the voltage channel in units of volts. The default is 0.

### Hardware Configuration Controls

As indicated in the main window, the hardware configuration controls must reflect the actual configuration of the power stage and analog control boards. If there is a mismatch between the settings in these controls and the actual hardware configuration, excessive current can be sourced into (or sunk from) the battery.

**ADC Range (V)** is the nominal ADC input range, with a default of 5 V.

**DAC Range(V)** is the nominal DAC output range, with a default of 5 V.

**Sense Resistor (Ohms)** is the nominal value of the sense resistor on the power stage board. The default is 0.002  $\Omega$  (2 m $\Omega$ ).

**Current Sense Gain** is the gain setting for the AD8450 programmable gain current sense instrumentation amplifier. The default value is 66.

**Voltage Sense Gain** is the gain setting for the AD8450 programmable gain differential voltage sense amplifier. The default is 0.8.

Clicking **Reset Ahr Meter** resets the amp-hour counter in the main window to 0.

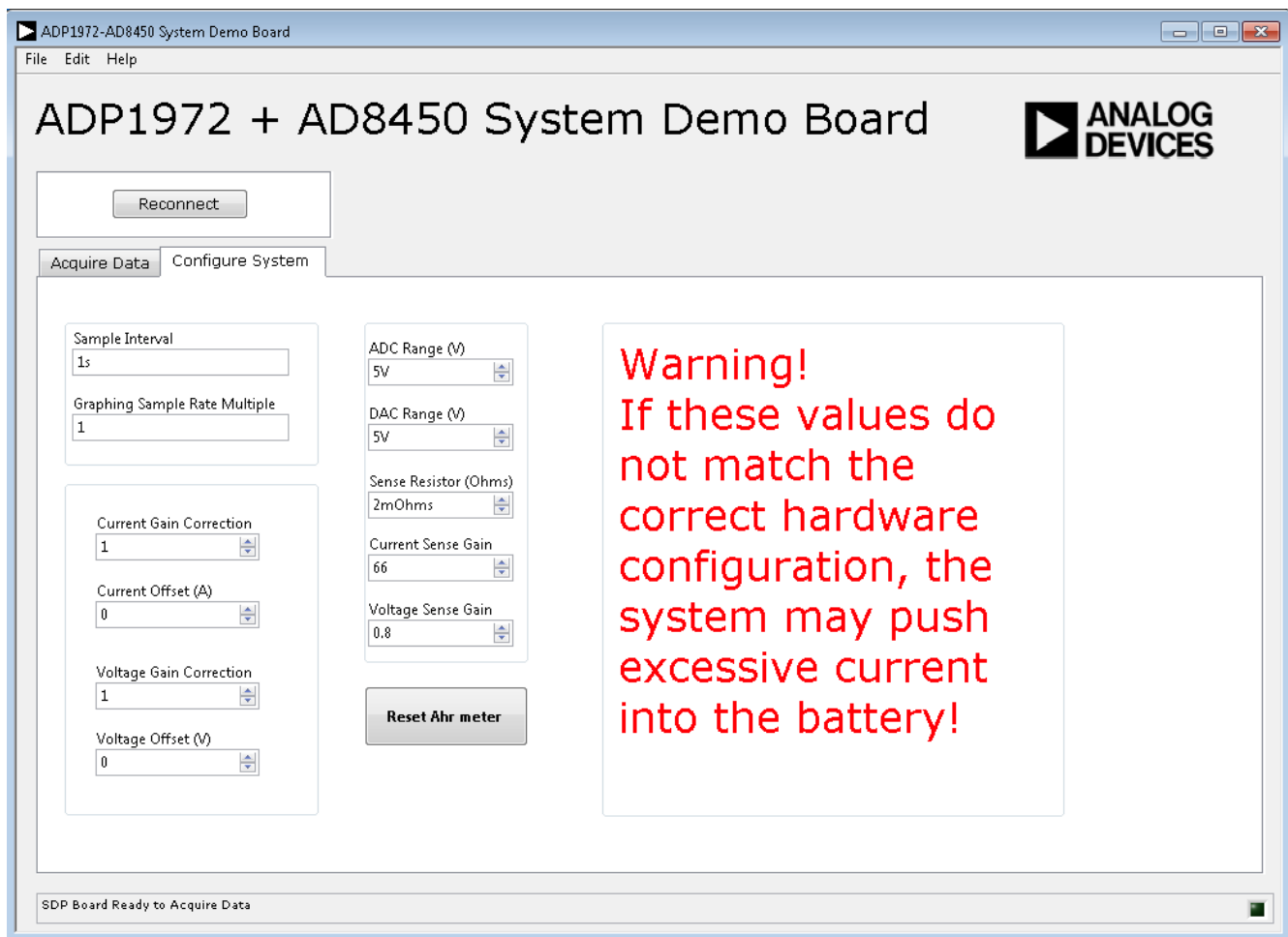

Figure 16. Configuration Tab

EVALUATION BOARD SCHEMATICS—POWER STAGE BOARD

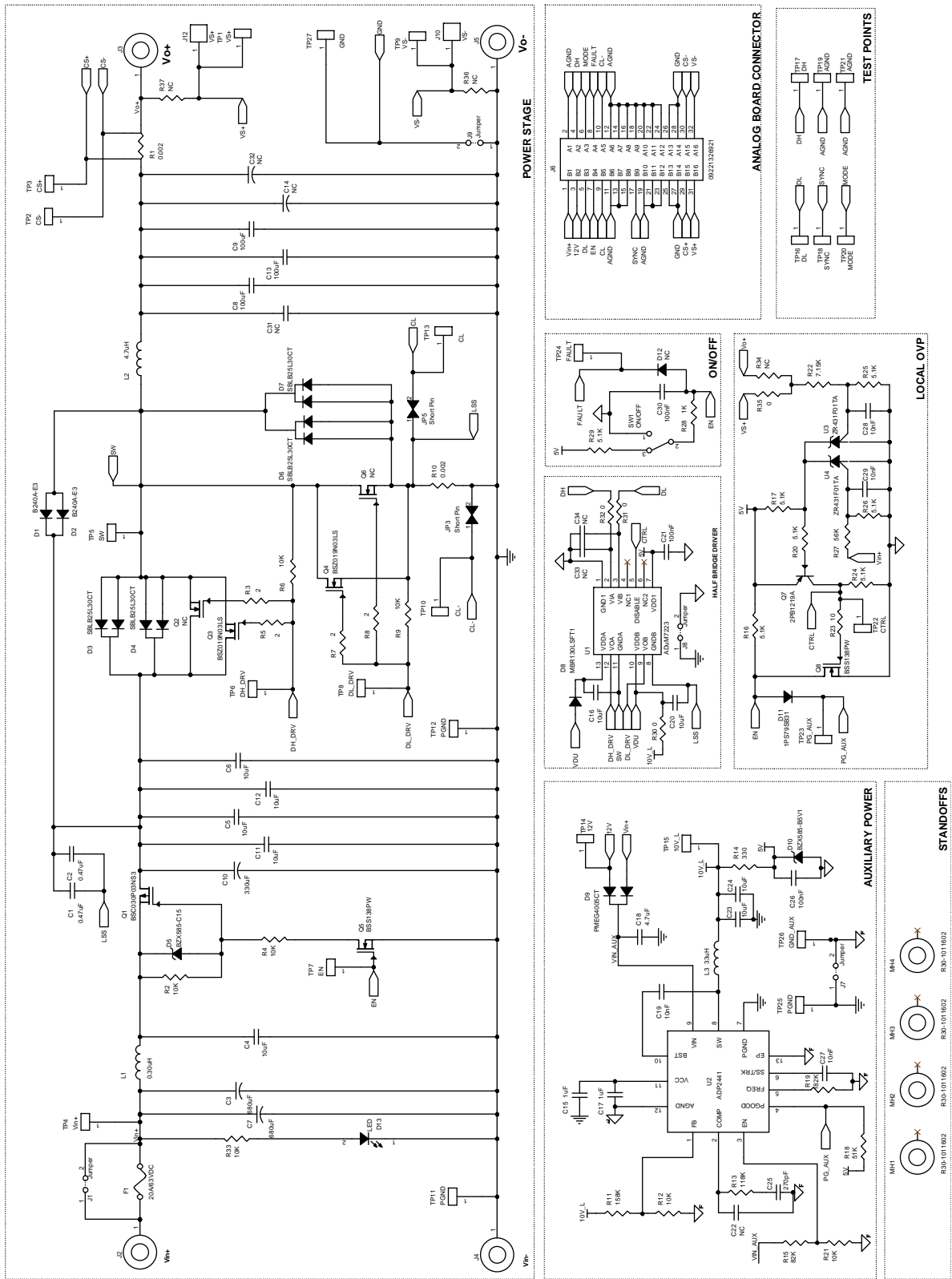
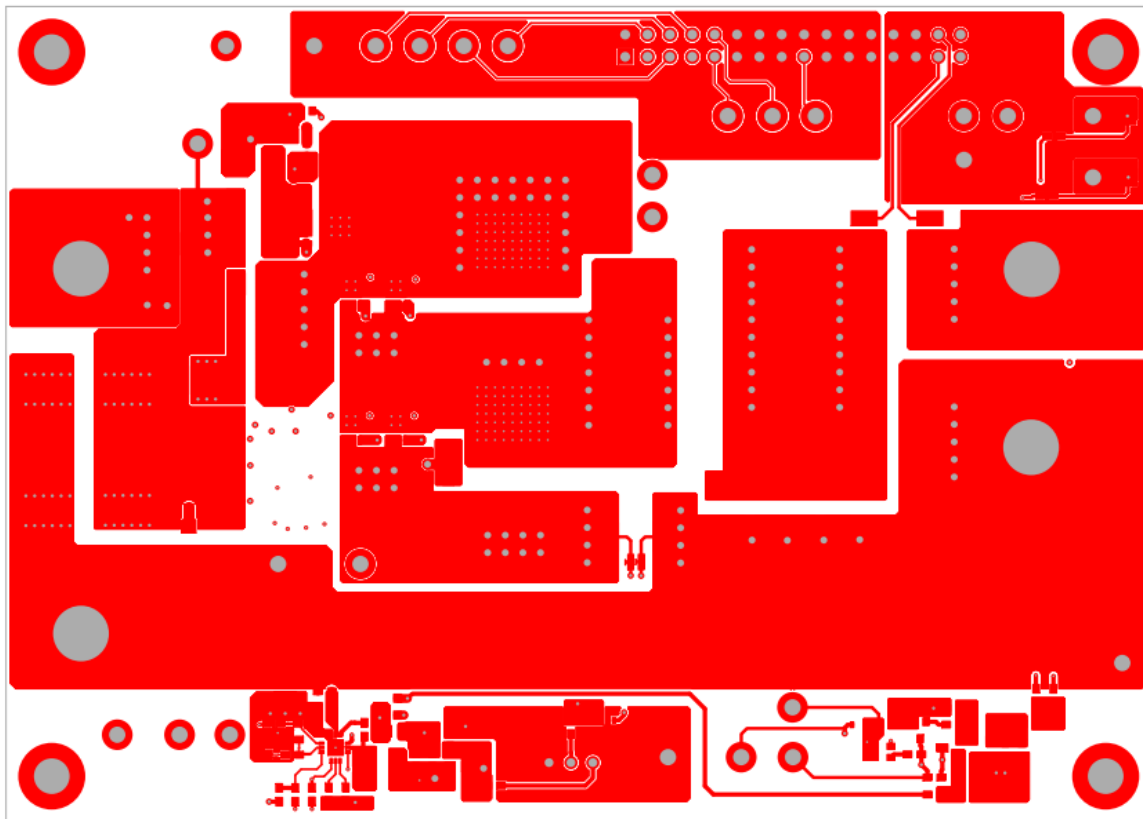
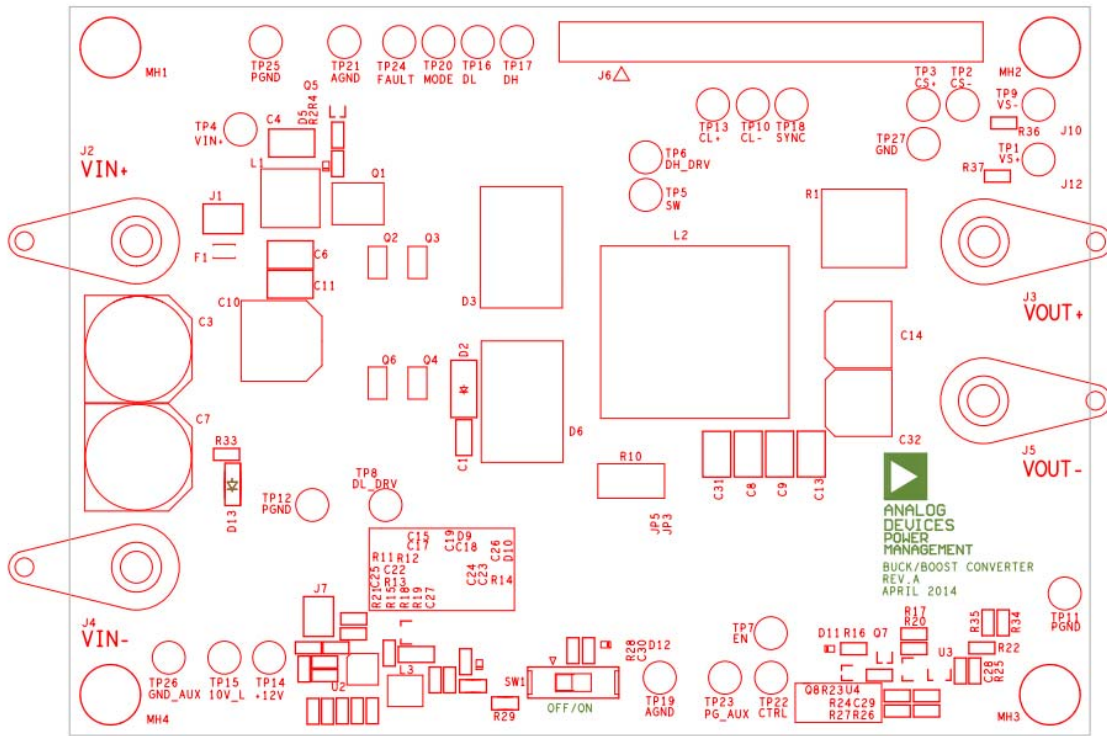
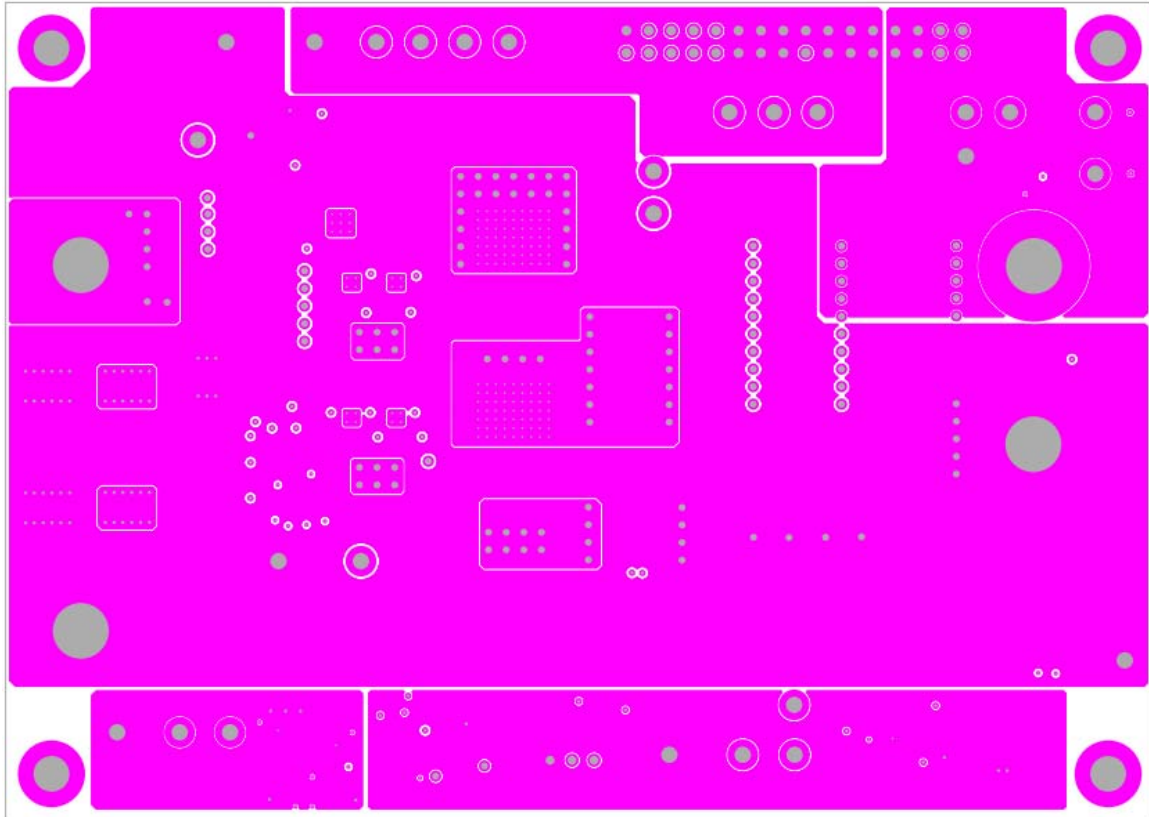

Figure 17. Power Stage Board Schematic

Table 4. Power Stage Board Bill of Materials

Reference Designator	Description	Manufacturer	Part No.
C1, C2	0.47 $\mu$ F/100 V, X7R, MLCC	Murata	GRM21BR72A474KA73
C3, C7	680 $\mu$ F/35 V, aluminum electrolytic capacitor	Panasonic	EEVFK1V681Q
C4, C5, C6, C11, C12	10 $\mu$ F/50 V, X5R, MLCC	Murata	GRM32ER61H106KA12
C8, C9, C13, C31	100 $\mu$ F/6.3 V, X5R, MLCC	Murata	GRM32ER60J107ME20
C10, C22, C32, C33, C34, D12, Q2, Q6, R34, R36, R37	10 mm diameter, aluminum solid electrolytic capacitor	Not applicable	Not applicable
C14	1000 $\mu$ F/6.3 V, aluminum solid electrolytic capacitor	Nichicon	RHS0J102MCN1GS
C15, C17	1 $\mu$ F/16 V, X7R, MLCC	TDK	C1608X7R1C105KT
C16, C20, C23, C24	10 $\mu$ F/25 V, X5R, MLCC	Murata	GRM188R61E106MA73
C18	4.7 $\mu$ F/50 V, X5R, MLCC	Murata	GRM21BR61E475KA12
C19, C27	10 nF/50 V, C0G, MLCC	Murata	GRM1885C1H103JA01
C21, C26, C30	100 nF/16 V, X7R, MLCC	TDK	C1608X7R1C104KT
C25	270 pF/50 V, C0G, MLCC	Murata	GRM1885C1H271JA01
C28, C29	10 nF/25 V, X7R, MLCC	Murata	GRM188R71E103KA01
D1, D2	40 V/2 A Schottky Diode	Vishay	B240A-E3
D3, D4, D6, D7	30 V/12.5 A (per) Schottky rectifier	Vishay	SBLB25L30CT-E3
D5	15 V Zener diode, 5%	NXP	BZX585-C15
D8	30 V/1 A Schottky diode	ON Semiconductor	MBR130LSFT1
D9	500 mA, low $V_F$ , dual, mega Schottky barrier rectifier	NXP	PMEG4005CT
D10	5.1 V Zener diode, 2%	NXP	BZX585-B5V1
D11	30 V/0.2 A, ultralow $V_F$ , mega Schottky diode	NXP	1PS79SB31
D13	SMT, blue LEDs, 1206 package size	CML	CMD15-21UBC/TR8
F1	20 A, 63 V dc, fast acting fuse	Schurter	3413.0331.22
J1, J7 to J9	Power connector jumper on PCB	Not applicable	Not applicable
J2 to J5	15 A banana jacks, pierced lug terminal	Emerson	108-0740-001
J6	2-row, 32-pin header	Harwin	09221326921
J10, J12, JP3, JP5	Single pad	None	Not applicable
L1	0.30 $\mu$ H/33 A inductor	Coilcraft	XAL7070-301ME
L2	4.7 $\mu$ H/37 A inductor	Vishay	IHLP8787MZER4R7M51
L3	33 $\mu$ H/0.47 A inductor	Coilcraft	LPS4012-333MR
MH1 to MH4	Standoff, HEX M3, THR, brass, 16 mm	Harwin, Inc.	P275RD125
Q1	30 V/3 mR/100 A power MOSFET	Infineon	BSC030P03NS3
Q3, Q4	30 V/1.9 mR/40 A power MOSFET	Infineon	BSZ019N03LS
Q5, Q8	60 V/1.6 R/0.32 A MOSFET	NXP	BSS138PW
Q7	50 V/0.5 A PNP transistor	NXP	2PB1219A
R1	2 m $\Omega$ , 3637, SMD, 0.1% current sensing resistor	Vishay	Y14880R00200B9R
R2, R4, R6, R9, R12, R21, R33	10 k $\Omega$ , 0603, SMD, 1% generic resistor	Yageo	RC0603FR-0710KL
R3, R5, R7, R8	2 $\Omega$ , 0603, SMD, 5% generic resistor	Yageo	RC0603JR-072RL
R10	2 m $\Omega$ , 2512, SMD, 1% current sensing resistor	Stackpole Electronics, Inc.	CSNL2512FT2L00
R11	158 k $\Omega$ , 0603, SMD, 1% generic resistor	Yageo	RC0603FR-07158KL
R13	118 k $\Omega$ , 0603, SMD, 1% generic resistor	Yageo	RC0603FR-07118KL
R14	330 $\Omega$ , 0805, SMD, 5% generic resistor	Yageo	RC0805JR-07330RL
R15	82 k $\Omega$ , 0603, SMD, 1% generic resistor	Yageo	RC0603FR-0782KL
R16, R17, R20, R24, R26, R29	5.1 k $\Omega$ , 0603, SMD, 1% generic resistor	Yageo	RC0603FR-075K1L
R18	51 k $\Omega$ , 0603, SMD, 1% generic resistor	Yageo	RC0603FR-0751KL
R19	182 k $\Omega$ , 0603, SMD, 1% generic resistor	Yageo	RC0603FR-07182KL
R22	715 $\Omega$ , 0603, SMD, 1% generic resistor	Yageo	RC0603FR-0715RKL
R23	10 $\Omega$ , 0603, SMD, 1% generic resistor	Yageo	RC0603FR-0710RL
R25	510 $\Omega$ , 0603, SMD, 1% generic resistor	Yageo	RC0603FR-0510RKL
R27	56 k $\Omega$ , 0603, SMD, 1% generic resistor	Yageo	RC0603FR-0756KL
R28	100 $\Omega$ , 0603, SMD, 1% generic resistor	Yageo	RC0603FR-07100RL
R30 to R32, R35	0 $\Omega$ , 0603, SMD 5% generic resistor	Yageo	RC0603JR-070RL
SW1	Switch, slide, SPDT, 30 V/2 A, PC mount	E-Switch	EG1903-ND
TP1 to TP27	PC test point, multipurpose, 1.78 mm diameter, red	Keystone	5010
U1	Isolated, 4 A, half-bridge gate driver	Analog Devices	<a href="#">ADuM7223ACCZ</a>
U2	36 V, 1 A, synchronous step-down dc-to-dc regulator	Analog Devices	<a href="#">ADP2441ACPZ</a>
U3, U4	$V_{REF} = 2.5$ V, 1%	Diodes, Inc.	ZR431F01TA





13266-020

Figure 20. Power Stage Board Layer 2

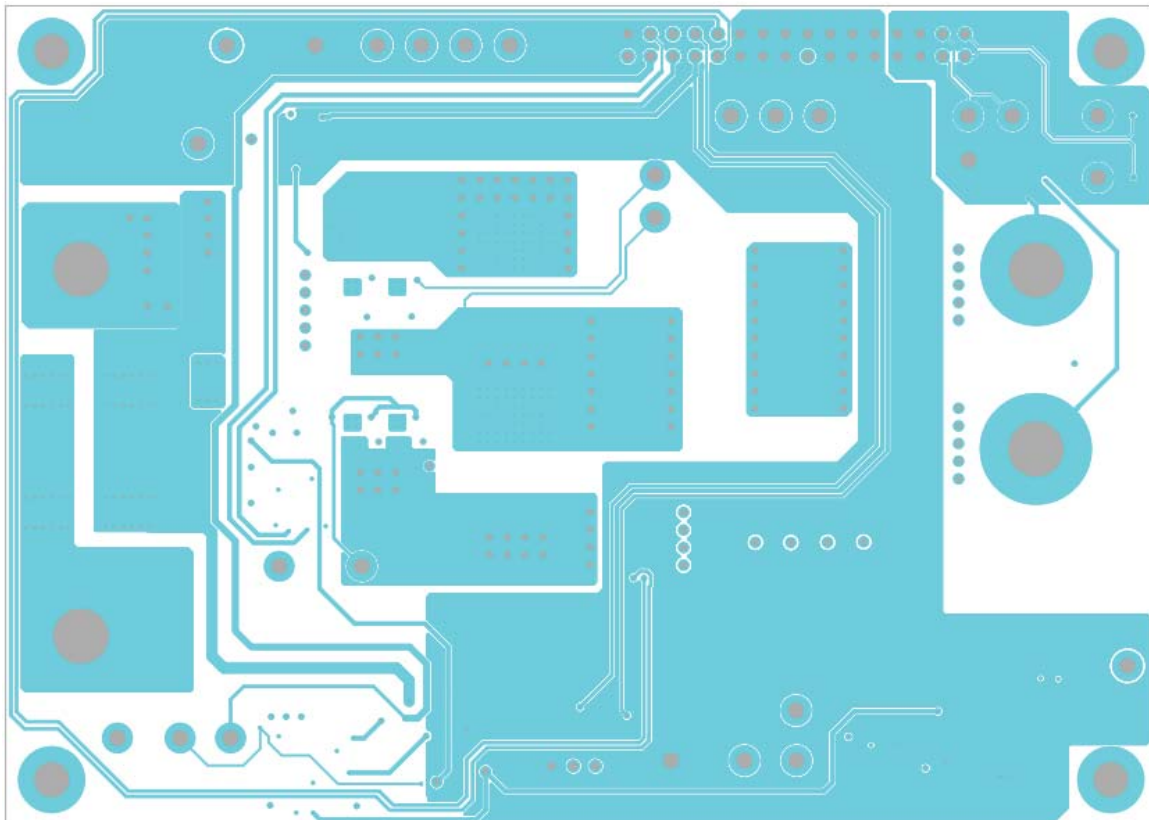

13266-021

Figure 21. Power Stage Board Layer 3



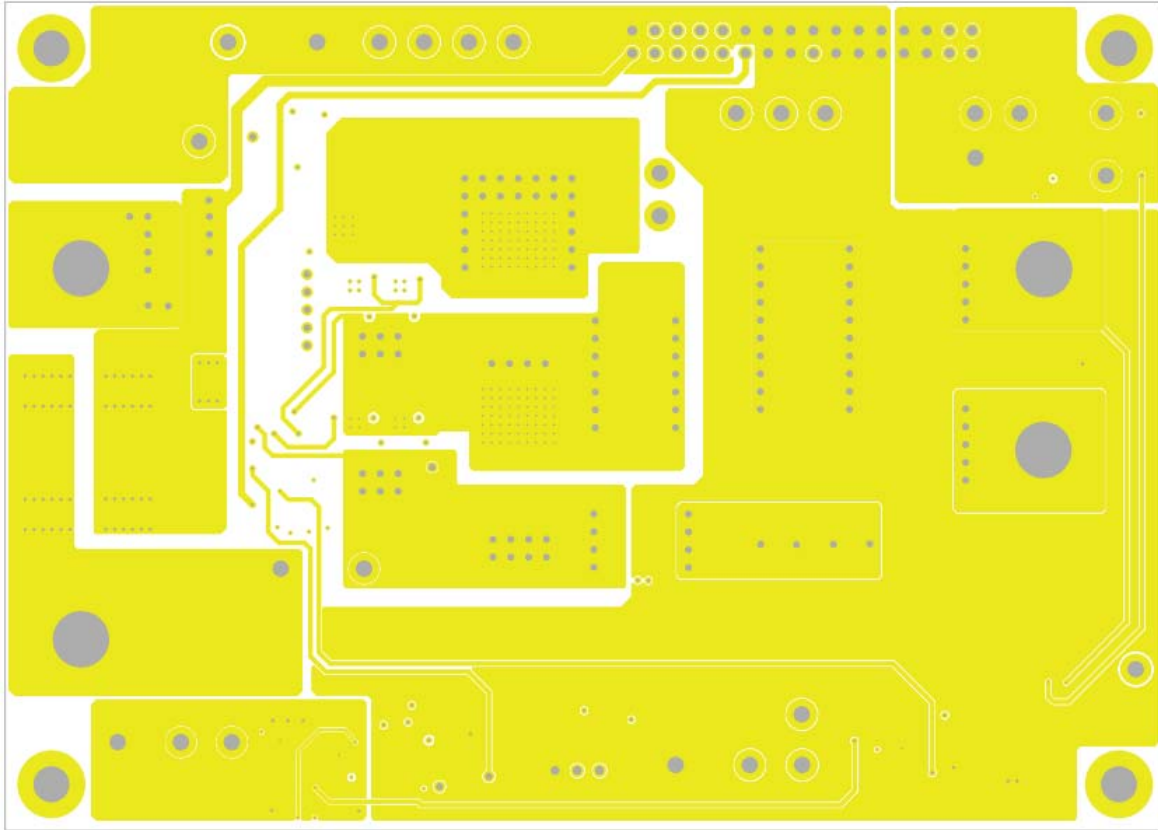

1326B-022

Figure 22. Power Stage Board Layer 4

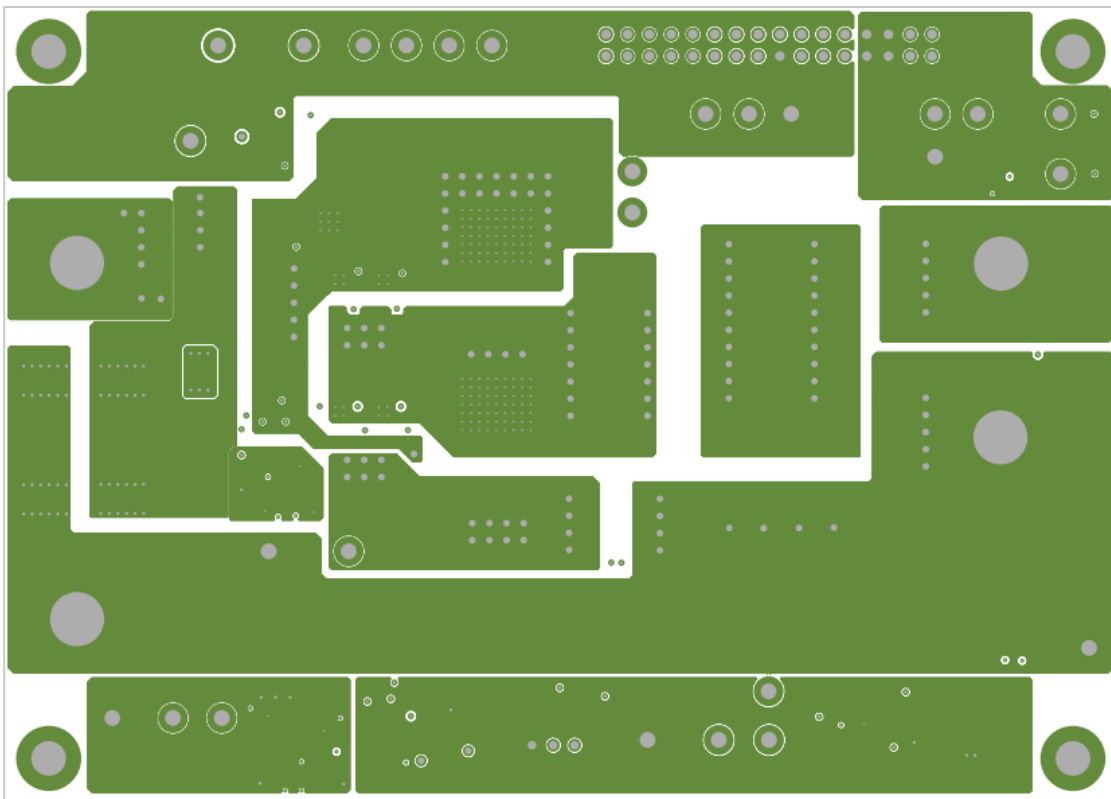

1326B-023

Figure 23. Power Stage Board Layer 5

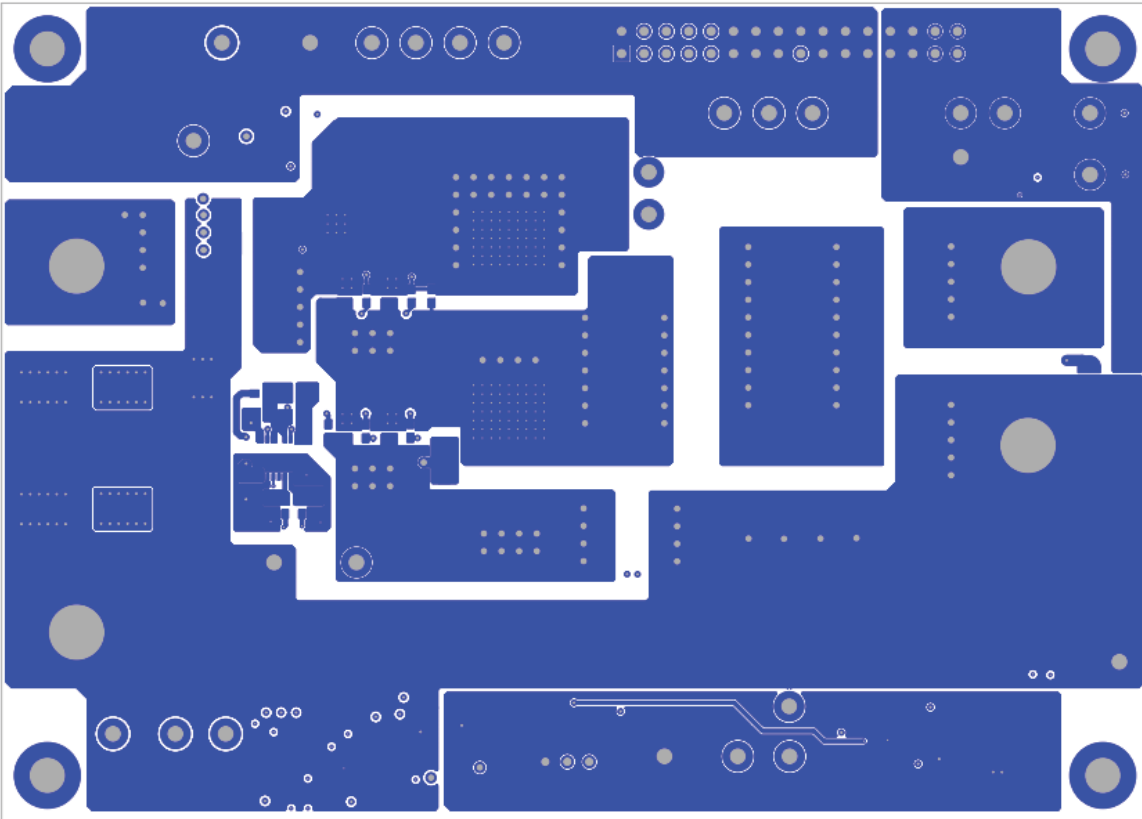

13268-024

Figure 24. Power Stage Board Bottom Layer

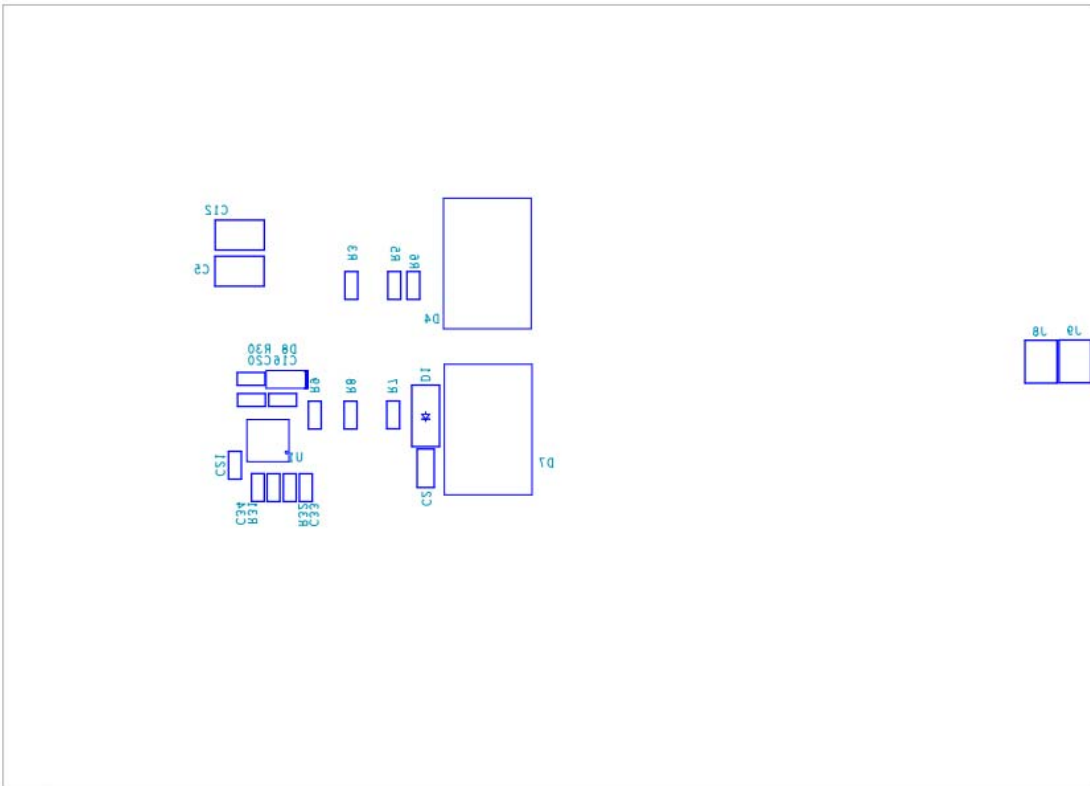

13268-025

Figure 25. Power Stage Board Bottom Silkscreen

EVALUATION BOARD SCHEMATICS—ANALOG CONTROL BOARD

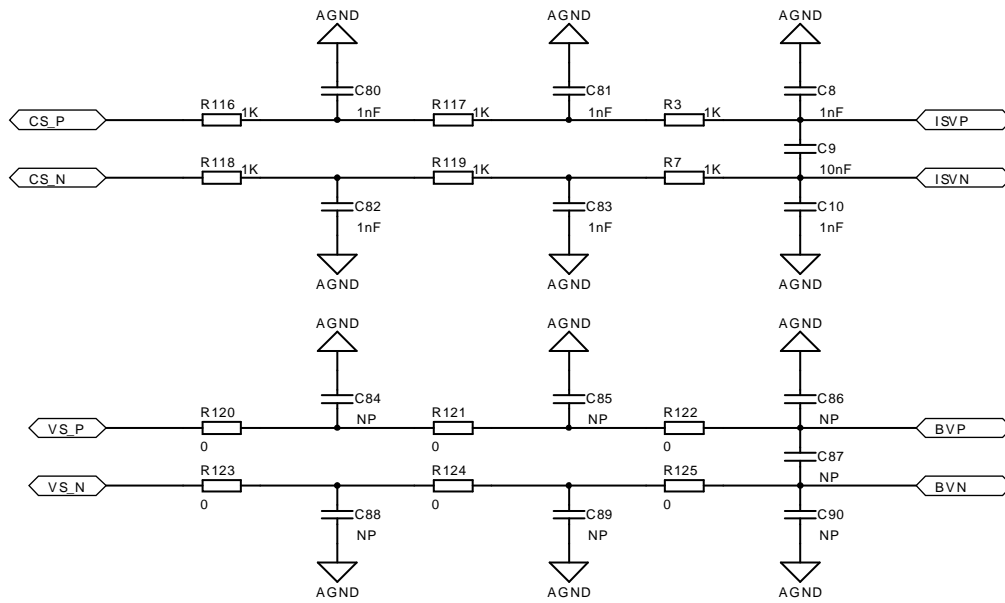

Figure 26. Voltage and Current Sense Input Filters

13268-026

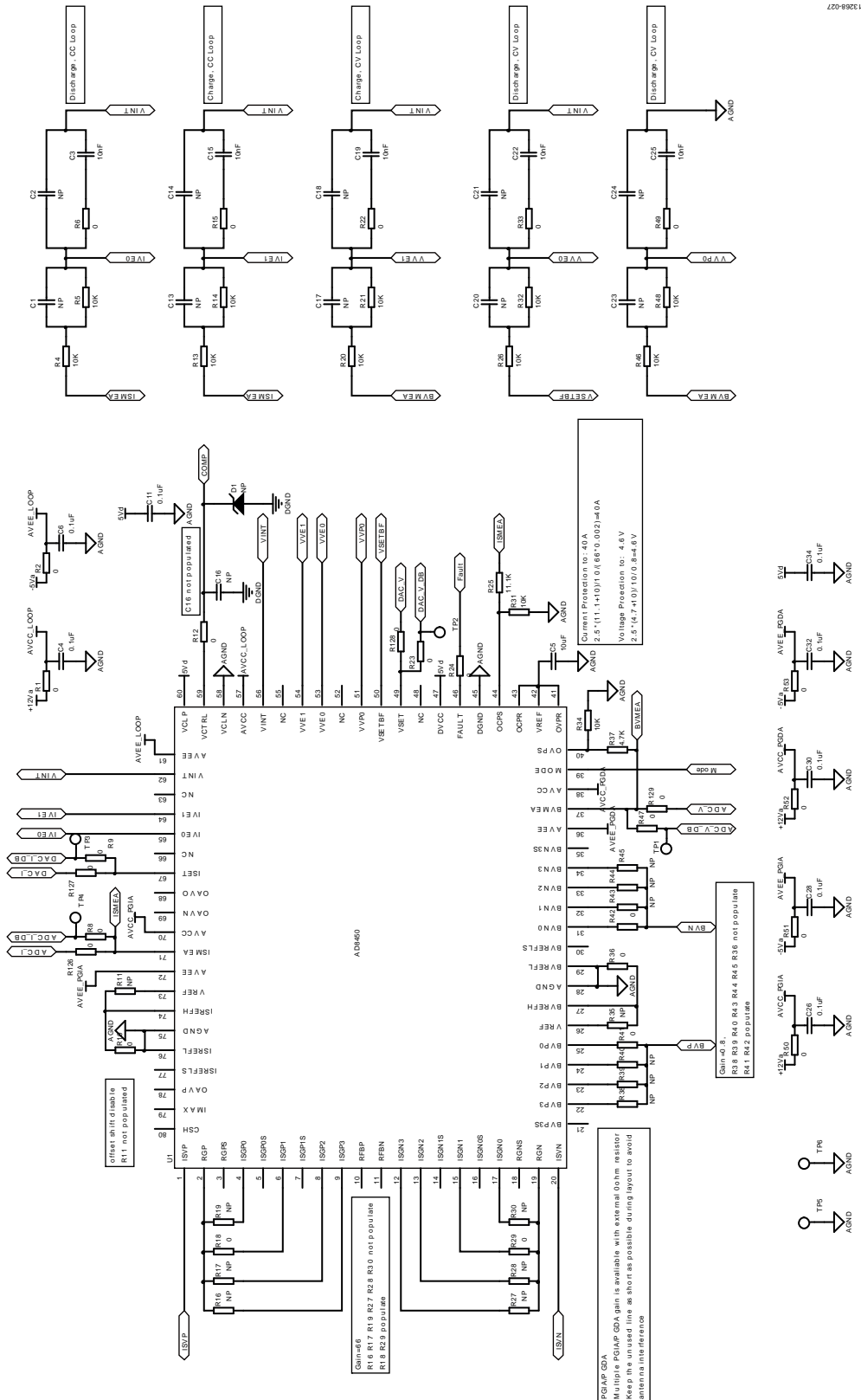

Figure 27. AD8450 and Compensation Networks

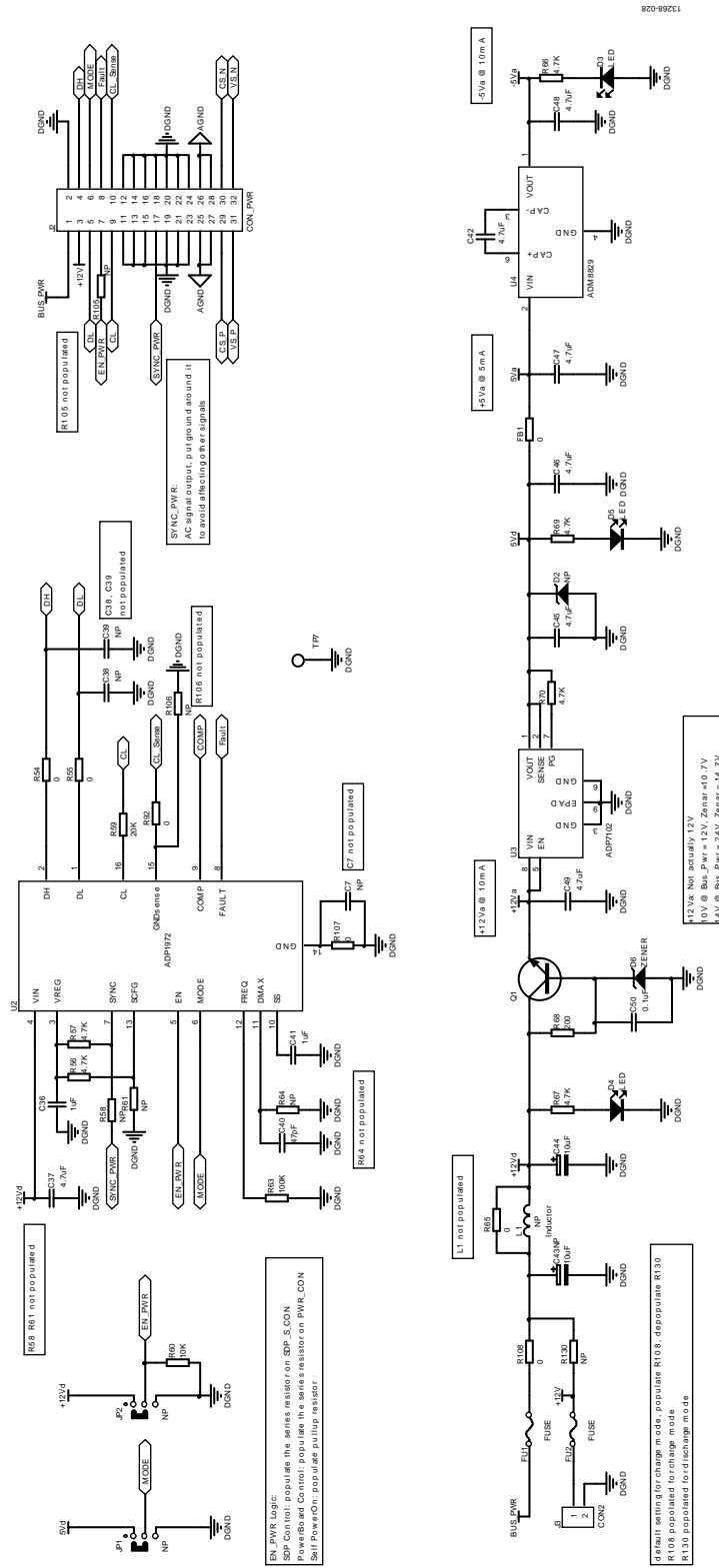

Figure 28. ADP1972 and Local Power Supplies

13268-029

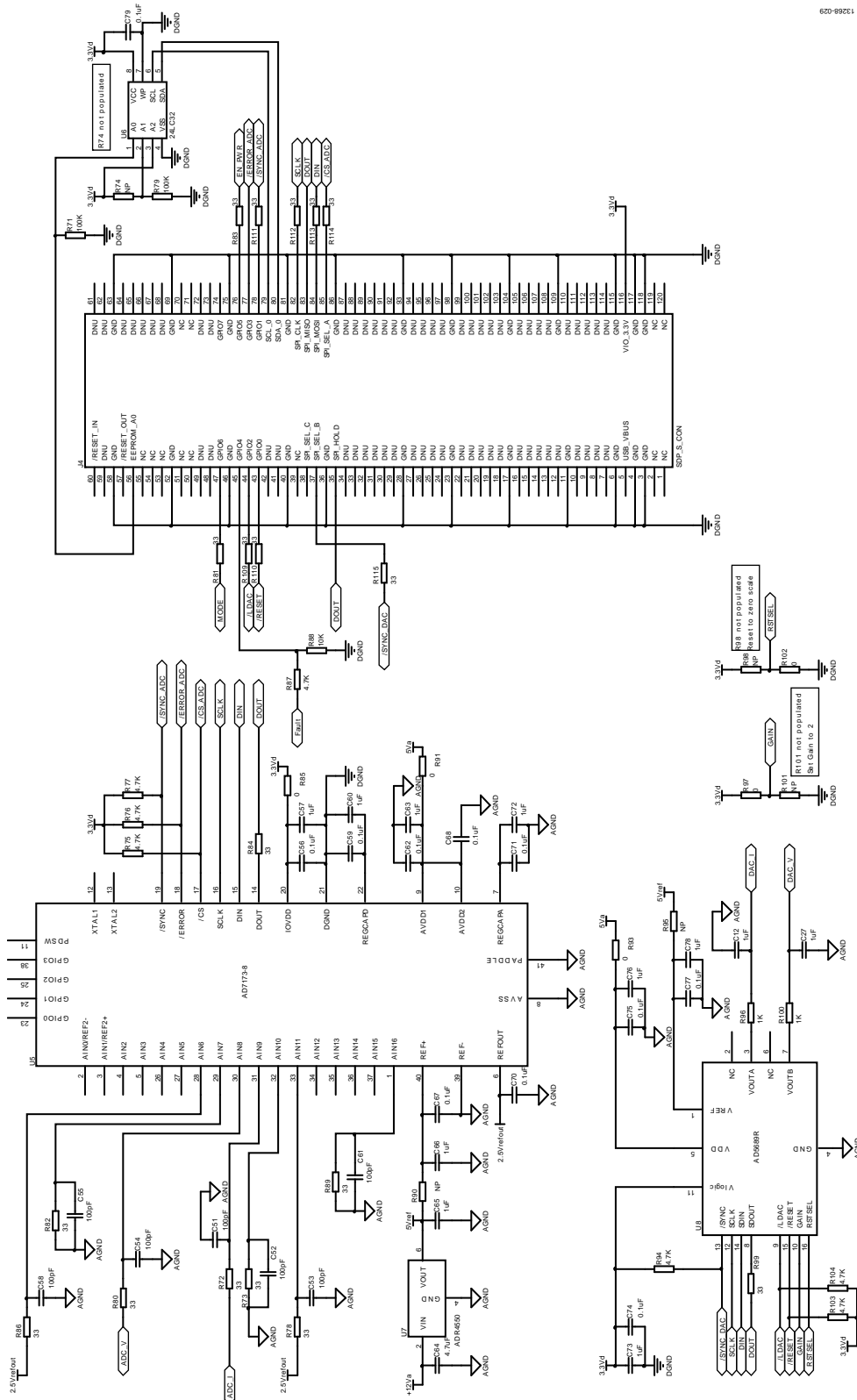
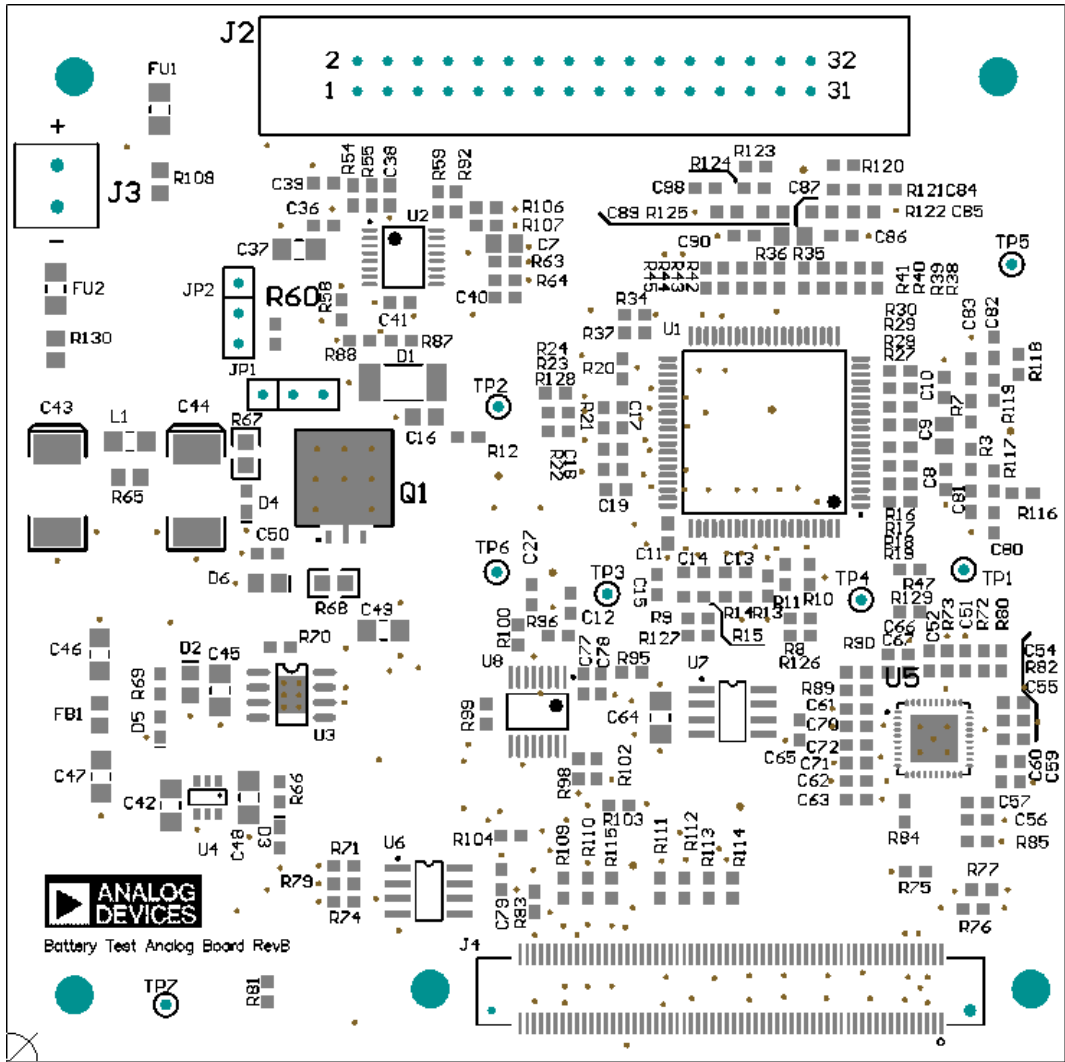

Figure 29. ADC, DAC, and SDP-5 Connector

Table 5. Analog Control Board Bill of Materials

Reference Designator	Description	Manufacturer	Part Number
C1, C2, C13, C14, C17, C18, C20, C21, C23, C24, C38, C39, C84 to C86, C88 to C90	Not applicable	Not applicable	Not applicable
C12, C27, C36, C41, C57, C60, C63, C65, C66, C72, C73, C76, C78	Ceramic capacitor, 0603, 1.0 $\mu$ F, 25 V	Murata	GRM188R71E105KA12D
C3, C15, C19, C22, C25	Ceramic capacitor, 0603, 10 nF, 50 V, X7R	AVX	06035C103KAT2A
C37, C42, C45 to C49, C64	Ceramic capacitor, 1206, 50 V, 4.7 $\mu$ F	AVX	12065C475KAT2A
C4, C6, C11, C26, C28, C30, C32, C34, C50, C56, C59, C62, C67, C68, C70, C71, C74, C75, C77, C79	Ceramic capacitor, 0603, X7R, 50 V, 100 nF	AVX	06035C104K4Z2A
C40	Ceramic capacitor, 0603, 47 pF, 50 V	AVX	06035A470JAT2A
C43, C44	Tantalum capacitor, 50 V, 10 $\mu$ F	Vishay	293D106X9050D2TE3
C5	Ceramic capacitor, 10 $\mu$ F, 10 V, X7R, 0805	TDK	C2012X7R1A106K125AC
C51, C52 to, C55, C58, C61	Ceramic capacitor, 0603, 100 pF, 50 V	AVX	06035A101JAT2A
C7, C16, C87	Not applicable	Not applicable	Not applicable
C8, C10, C80 to C83	Ceramic capacitor, 0603, 1 nF, 50 V	AVX	06035A102JAT2A
C9	Ceramic capacitor, 0805, 10 nF, 25 V, C0G	Kemet	C0805C103J3GACTU
D1	Not applicable	Not applicable	Not applicable
D2	Not applicable	Not applicable	Not applicable
D3 to D5	Yellow LED	Rohm	SML-311YTT86K
D6	Zener diode, 12 V, 0.2 W	ON Semiconductor	MM3Z12VT1G
FB1, R65, R108	0 $\Omega$ (jumper), 125 mW	Vishay	CRCW08050000ZSTA
FU1, FU2	Fuse, 1206, fast, 125 mA	Littelfuse	0466.125NR
J2	Connector, DIN41612, B/2, 32	Harting	09 22 232 6825
J3	Connector	TE Connectivity	1776275-2
J4	SDP connector	Hirose	FX8-1205-SV(21)
JP1, JP2	Jumper, 2211S-03G	Multicomp	2211S-03G
L1	Not applicable	Not applicable	Not applicable
Q1	Transistor, NPN, SOT89, 0.9 W	Diodes, Inc.	2DD2679-13
R1, R2, R6, R8 to R10, R12, R15, R18, R22 to R24, R29, R33, R36, R41, R42, R47, R49 to R55, R85, R91 to R93, R97, R102, R107, R120 to R129	Resistor, 0603, 0 $\Omega$ (jumper), 1%	Vishay	CRCW06030000Z0EA
R11, R16, R17, R19, R27, R28, R30, R35, R38, R39, R40, R43 to R45, R58, R61, R64, R74, R90, R95, R98, R101, R105, R106	Not applicable	Not applicable	Not applicable
R130	Not applicable	Not applicable	Not applicable
R25	Resistor, 0603, 11 k $\Omega$	Multicomp	MC0063W0603111K
R3, R7, R96, R100, R116, R117 to R119	Resistor, 0603, 1 k $\Omega$ , 0.1%, 0.1 W	Panasonic	ERA3AEB102V
R37, R56, R57, R66, R69, R70, R75 to R77, R87, R94, R103, R104	Resistor, 0603, 4.7 k $\Omega$ , 1%	Vishay	CRCW06034K70FKEA
R4, R5, R13, R14, R20, R21, R26, R31, R32, R34, R46, R48, R60, R88	Resistor, 0603, 10 k $\Omega$ , 1%	Vishay	CRCW060310K0FKEA
R59	Resistor, 0603, 20 k $\Omega$ , 1%	Vishay	CRCW060320K0FKEA
R63, R71, R79	Resistor, 0603, 100 k $\Omega$ , 1%	Vishay	CRCW0603100KFKEA
R67	Resistor, 0805, 4.7 k $\Omega$ , 1%	Vishay	CRCW08054K70FKEA
R68	Resistor, 0805, 200 $\Omega$ , 1%	Vishay	CRCW0805200RFKEA
R72, R73, R78, R80 to R84, R86, R89, R99, R109, R110 to R115	Resistor, 0603, 1%, 50 ppm, 33 $\Omega$	Yageo	RT0603FRE0733RL
TP1 to TP7	Test point	Vero	20-313141
U1	Precision analog front end and controller for testing and monitoring battery cells	Analog Devices	<a href="#">AD8450</a>
U2	Asynchronous buck or boost PWM controller	Analog Devices	<a href="#">ADP1972</a>
U3	20 V, high input voltage LDO	Analog Devices	<a href="#">ADP7102</a>
U4	Charge pump voltage inverter	Analog Devices	<a href="#">ADM8829</a>
U5	Fast settling, highly accurate, low power, 8-/16-channel, multiplexed ADC	Analog Devices	<a href="#">AD7173-8</a>
U6	EEPROM	Microchip	24LC32A-I/SN
U7	5 V, high precision, low power, low noise voltage reference	Analog Devices	<a href="#">ADR4550</a>
U8	Dual, 16-bit, rail-to-rail, voltage output DAC	Analog Devices	<a href="#">AD5689R</a>



13288-030

Figure 30. Analog Control Board Top Silkscreen



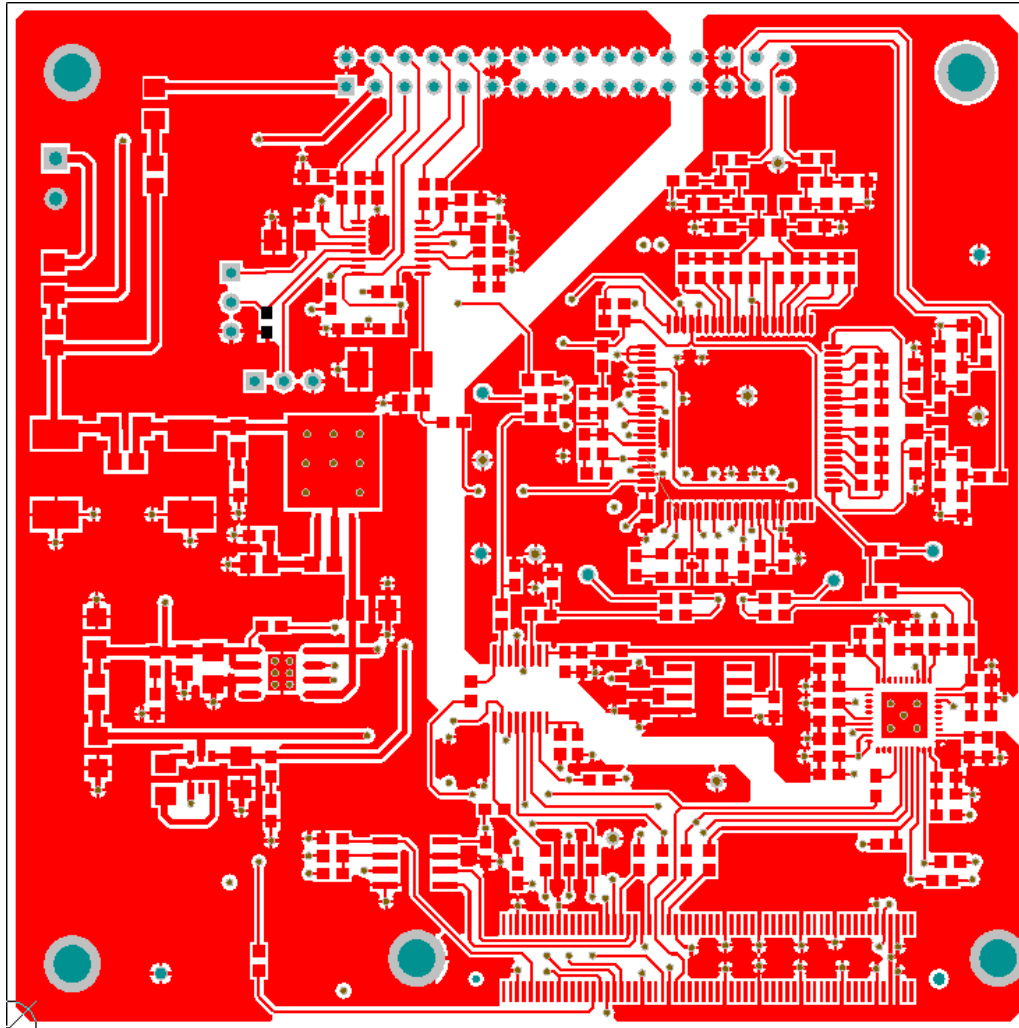

13288-031

Figure 31. Analog Control Board Top Layer

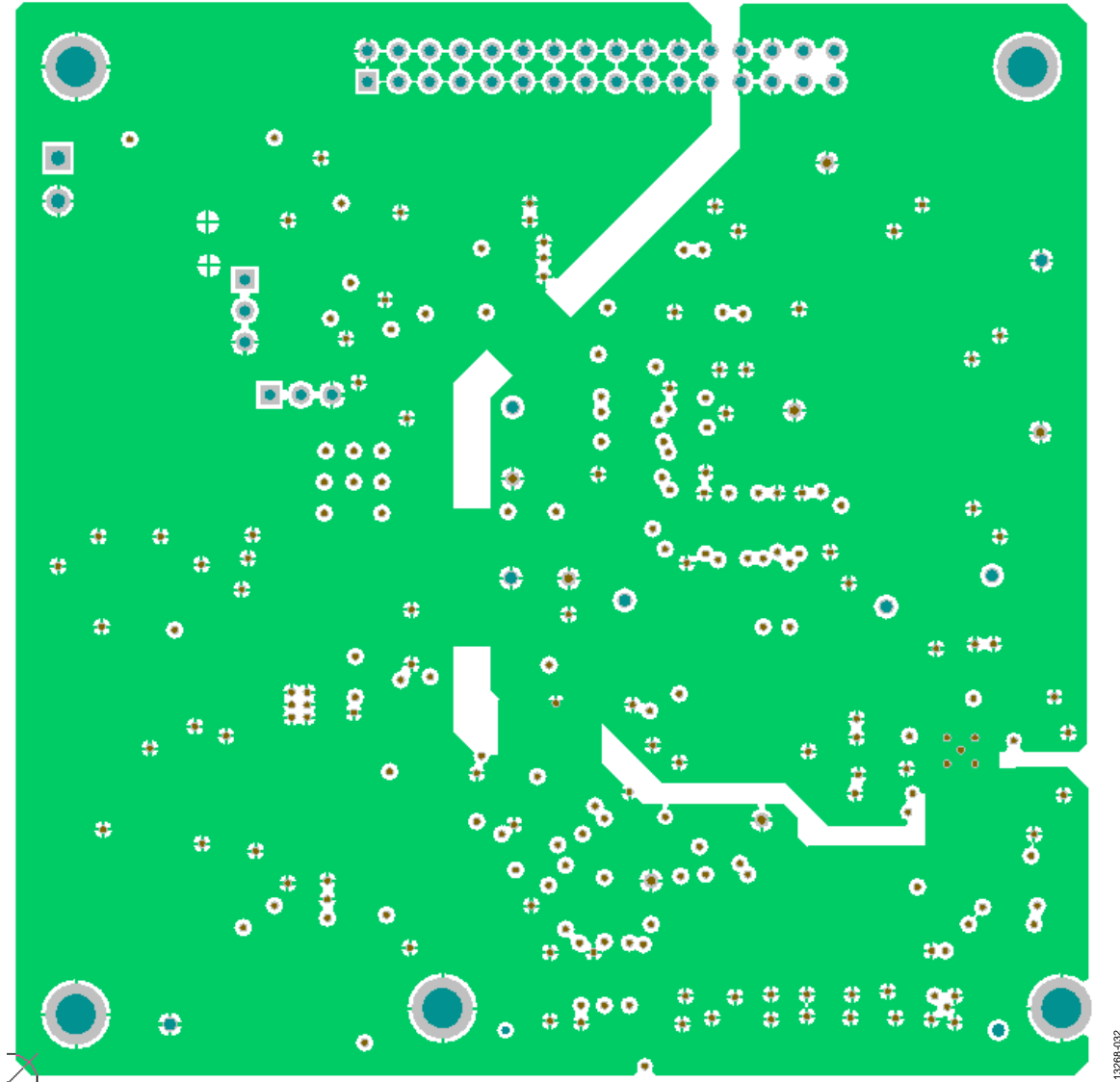

13268-032

Figure 32. Analog Control Board Layer 2 (Ground)

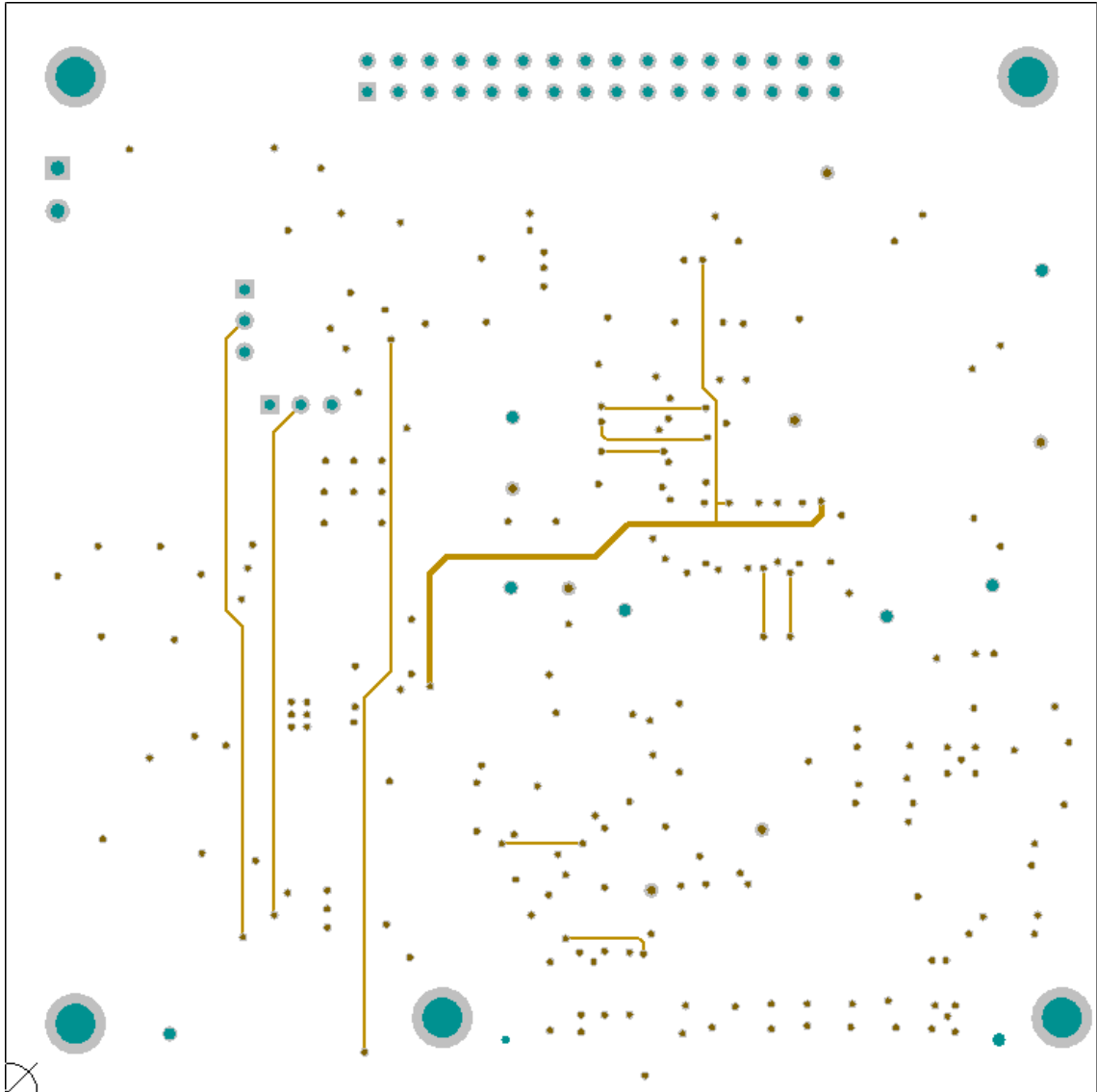

13266-033

Figure 33. Analog Control Board Layer 3

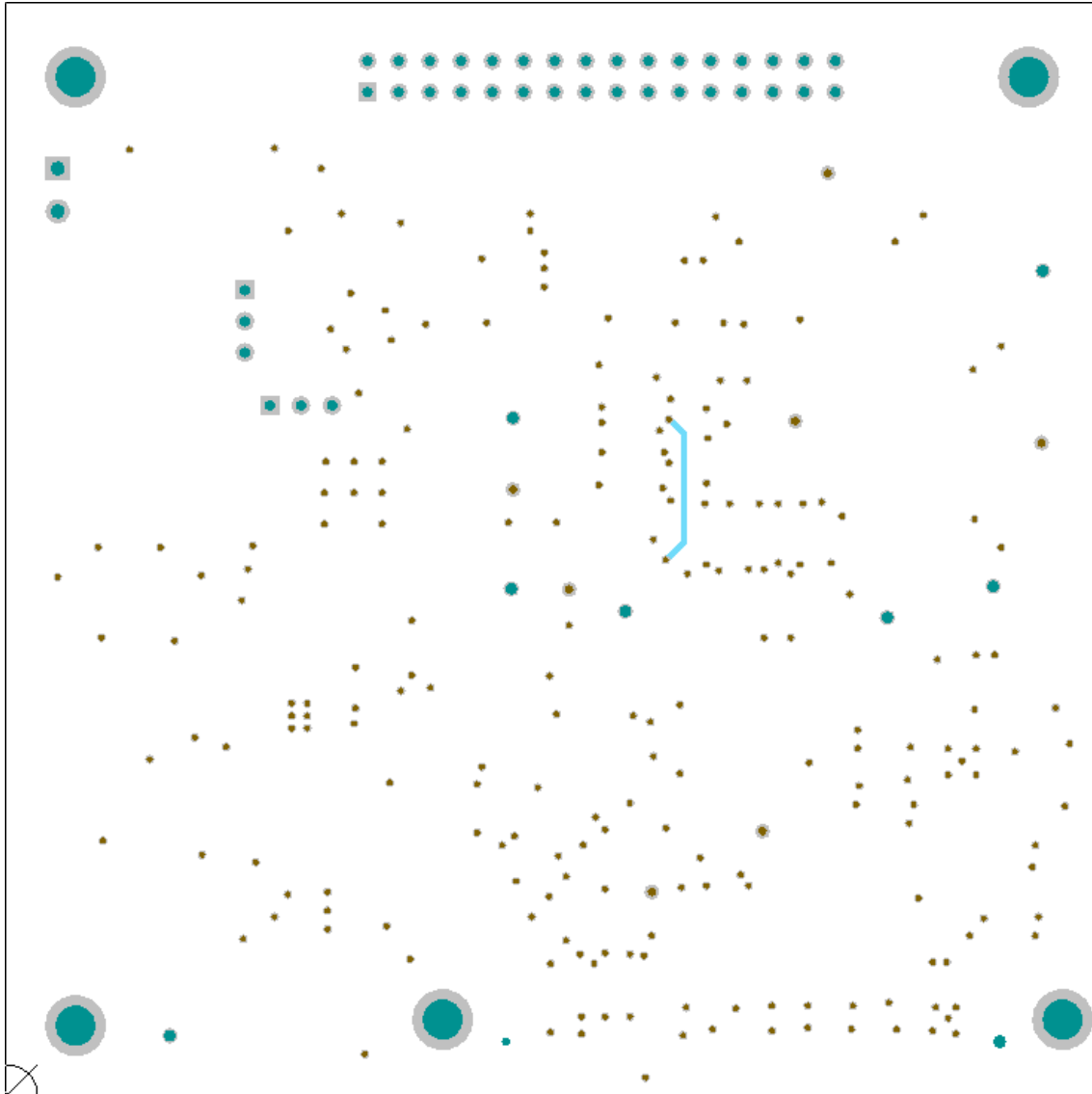

13266-034

Figure 34. Analog Control Board Layer 4

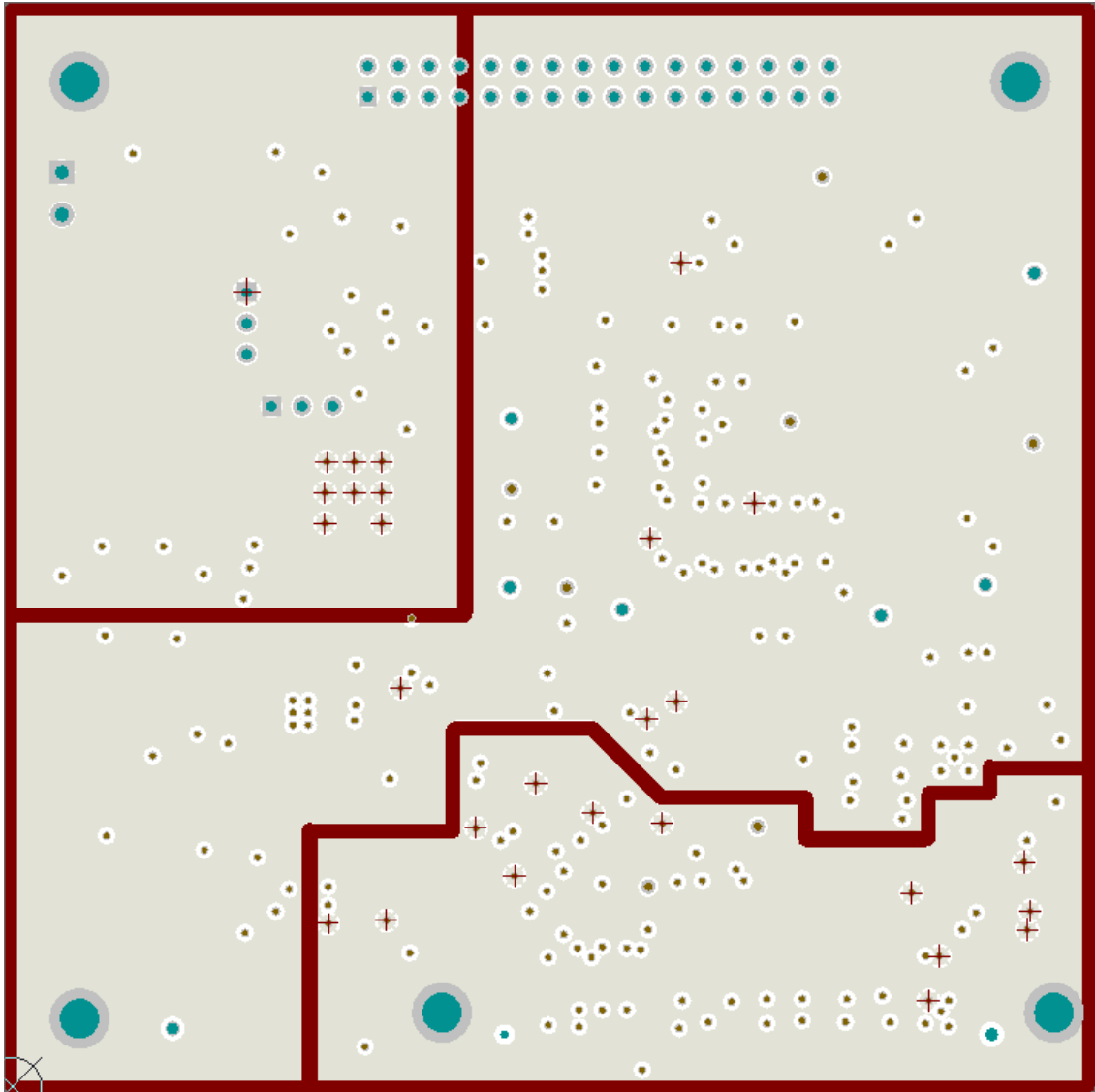
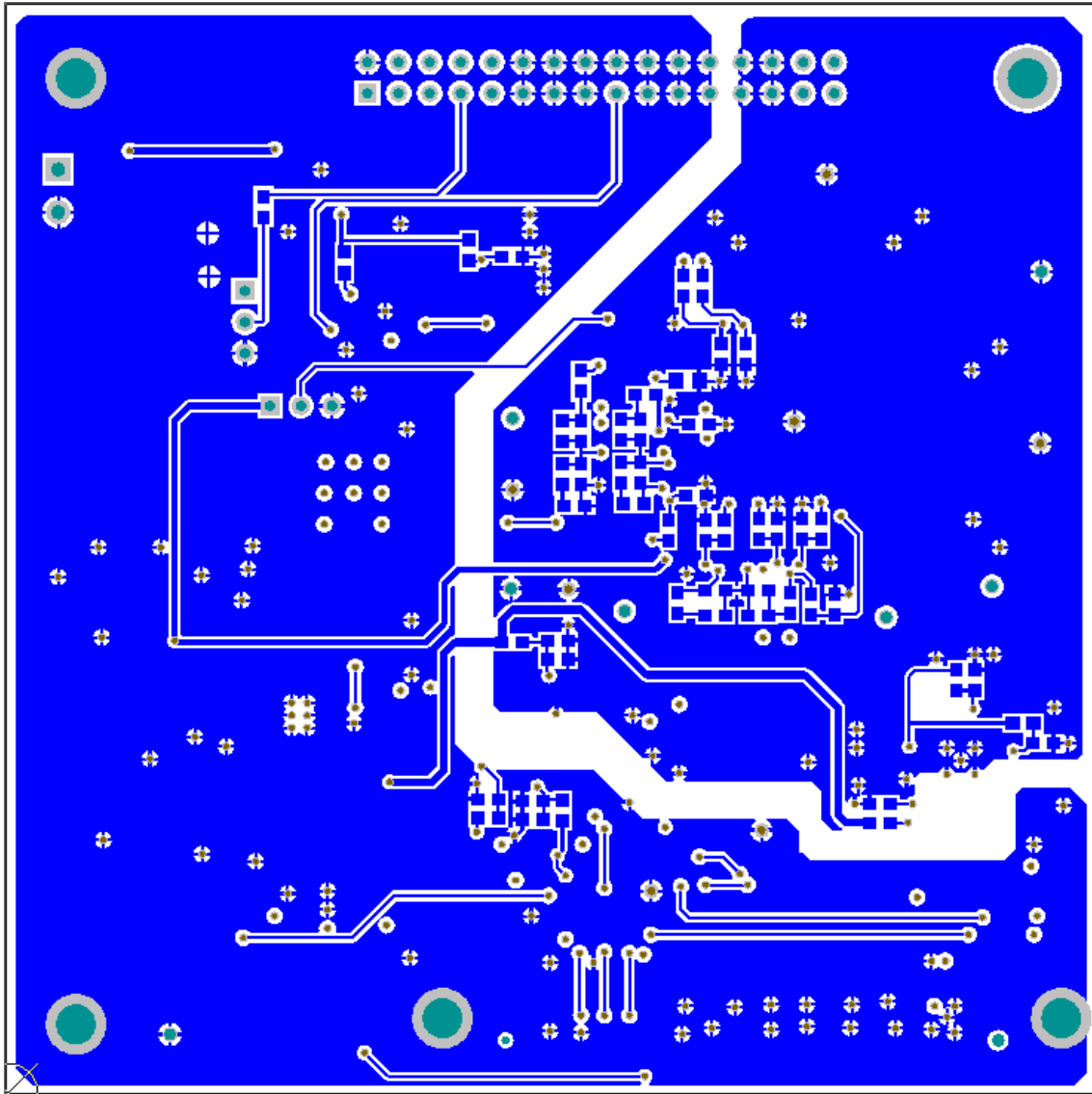

Figure 35. Analog Control Board Layer 5 (Power)

13208-035



13266-036

Figure 36. Analog Control Board Bottom Layer

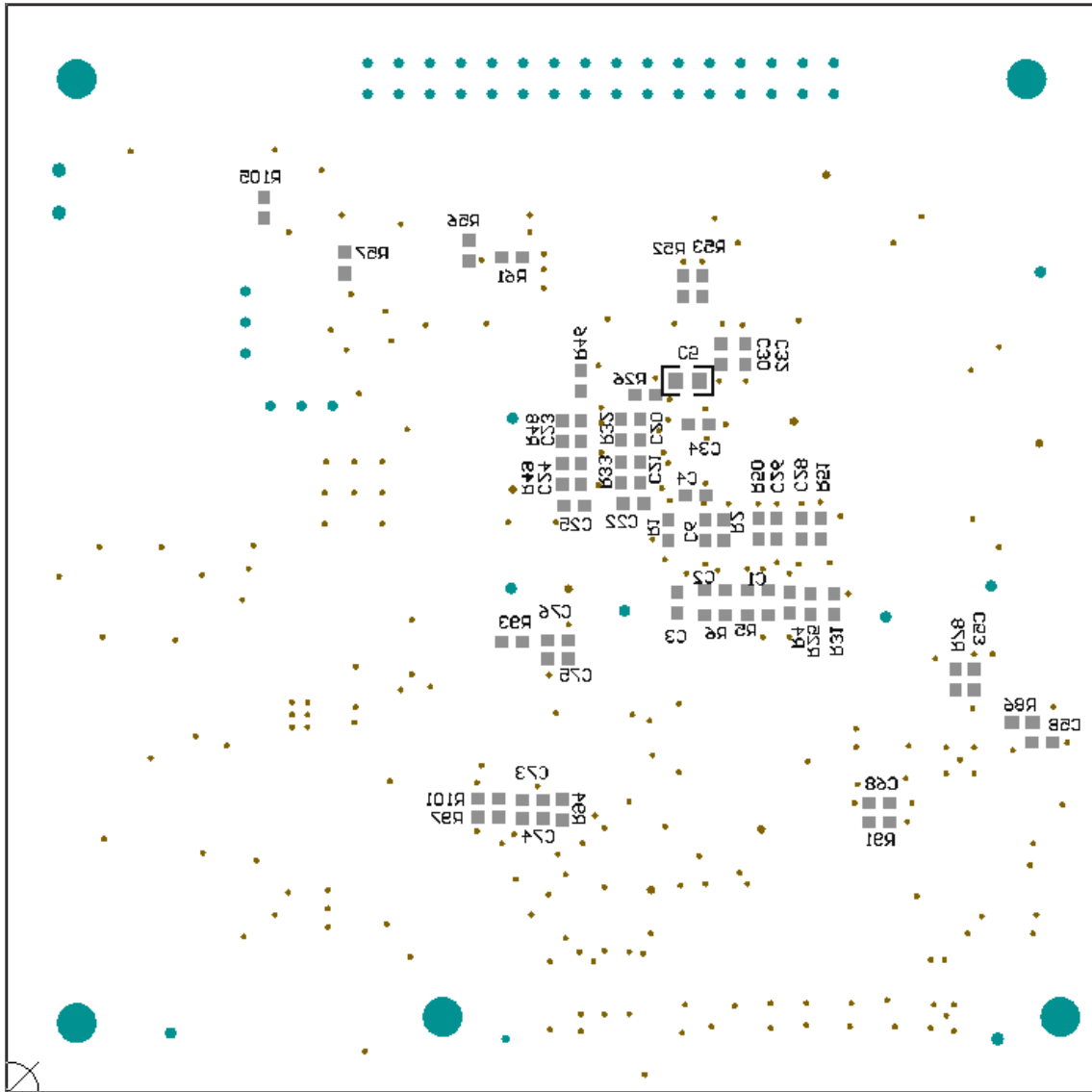

13286-037

Figure 37. Analog Control Board Bottom Silkscreen

## TROUBLESHOOTING

### SOFTWARE

To troubleshoot the software, take the following steps:

1. Always install the software prior to connecting the hardware to the PC.
2. Always allow the install to fully complete (the software is a 2-part install: the ADC software and the SDP drivers). Completing the install may require a restart.
3. When you first plug in the SDP-S board via the USB cable provided, allow the new **Found Hardware Wizard** to run. This step may take a little time; however, allow this to happen prior to starting the software.
4. Where the board does not appear to be functioning, ensure that the ADC evaluation board is connected to the SDP-S board and that the board is being recognized in the **Device Manager**, as shown in Figure 11.

### HARDWARE

To troubleshoot the hardware, take the following steps:

1. If the software does not read any data back, check that the power is applied within the power ranges described in the Powering the System section.
2. Using a voltmeter, verify the following voltages on the analog control board:
  - +5 V at U3, Pin 1
  - –5 V at U4, Pin 1
  - +12 V (or the actual input voltage to the system) at U3, Pin 8.
3. Launch the software and read the data. If nothing happens, exit the software.
4. Power down the board and relaunch the software.
5. If no data is read back, confirm that the power stage board is plugged into the analog control board, and that the analog control board is connected to the SDP-S board and that the board is being recognized in the **Device Manager**, as shown in Figure 11.



## PRODUCTS ON THIS EVALUATION SYSTEM

Table 6.

Product	Ordering Model	Description
AD8450/AD8451	AD8450ASTZ/AD8451ASTZ	Precision analog front end and controller for battery test/formation systems
ADP1972	ADP1972ARUZ	Buck or boost, PWM controller for battery test solutions
AD7173-8	AD7173-8BCPZ	Low power, 8-/16-channel, 31.25 kSPS, 24-bit, highly integrated $\Sigma$ - $\Delta$ ADC
AD5689R	AD5689RACPZ	Dual, 16-bit <i>nano</i> DAC+ with 2 ppm/ $^{\circ}$ C reference
ADP2441	ADP2441ACPZ	36 V, 1 A, synchronous step-down dc-to-dc regulator
ADP7102	ADP7102ACPZ	20 V, 300 mA, low noise, CMOS LDO
ADM8829	ADM8828ART	Switched capacitor voltage inverter with shutdown
ADuM7223	ADM7223ACCZ	Isolated precision half-bridge driver, 4 A output

## RELATED LINKS

Resource	Description
<a href="#">Battery Testing and Formation Analog Dialogue Article</a>	<i>Battery Testing and Formation</i> application page
<a href="#">Technical Article</a>	"Accurate Analog Controller Optimizes High-Efficiency Li-Ion Battery Manufacturing"
<a href="#">AN-1319</a>	<i>Power Efficient Battery Formation/Testing System with Energy Recycling</i>
<a href="#">AD8450/AD8451 Compensator Design Tool</a>	Application Note, <i>Compensator Design for a Battery Charge/Discharge Unit Using the AD8450 or the AD8451</i>
	Simulation design tools for the <a href="#">AD8450/AD8451</a>



### ESD Caution

**ESD (electrostatic discharge) sensitive device.** Charged devices and circuit boards can discharge without detection. Although this product features patented or proprietary protection circuitry, damage may occur on devices subjected to high energy ESD. Therefore, proper ESD precautions should be taken to avoid performance degradation or loss of functionality.

### Legal Terms and Conditions

By using the evaluation board discussed herein (together with any tools, components documentation or support materials, the "Evaluation Board"), you are agreeing to be bound by the terms and conditions set forth below ("Agreement") unless you have purchased the Evaluation Board, in which case the Analog Devices Standard Terms and Conditions of Sale shall govern. Do not use the Evaluation Board until you have read and agreed to the Agreement. Your use of the Evaluation Board shall signify your acceptance of the Agreement. This Agreement is made by and between you ("Customer") and Analog Devices, Inc. ("ADI"), with its principal place of business at One Technology Way, Norwood, MA 02062, USA. Subject to the terms and conditions of the Agreement, ADI hereby grants to Customer a free, limited, personal, temporary, non-exclusive, non-sublicensable, non-transferable license to use the Evaluation Board FOR EVALUATION PURPOSES ONLY. Customer understands and agrees that the Evaluation Board is provided for the sole and exclusive purpose referenced above, and agrees not to use the Evaluation Board for any other purpose. Furthermore, the license granted is expressly made subject to the following additional limitations: Customer shall not (i) rent, lease, display, sell, transfer, assign, sublicense, or distribute the Evaluation Board; and (ii) permit any Third Party to access the Evaluation Board. As used herein, the term "Third Party" includes any entity other than ADI, Customer, their employees, affiliates and in-house consultants. The Evaluation Board is NOT sold to Customer; all rights not expressly granted herein, including ownership of the Evaluation Board, are reserved by ADI. CONFIDENTIALITY. This Agreement and the Evaluation Board shall all be considered the confidential and proprietary information of ADI. Customer may not disclose or transfer any portion of the Evaluation Board to any other party for any reason. Upon discontinuation of use of the Evaluation Board or termination of this Agreement, Customer agrees to promptly return the Evaluation Board to ADI. ADDITIONAL RESTRICTIONS. Customer may not disassemble, decompile or reverse engineer chips on the Evaluation Board. Customer shall inform ADI of any occurred damages or any modifications or alterations it makes to the Evaluation Board, including but not limited to soldering or any other activity that affects the material content of the Evaluation Board. Modifications to the Evaluation Board must comply with applicable law, including but not limited to the RoHS Directive. TERMINATION. ADI may terminate this Agreement at any time upon giving written notice to Customer. Customer agrees to return to ADI the Evaluation Board at that time. LIMITATION OF LIABILITY. THE EVALUATION BOARD PROVIDED HEREUNDER IS PROVIDED "AS IS" AND ADI MAKES NO WARRANTIES OR REPRESENTATIONS OF ANY KIND WITH RESPECT TO IT. ADI SPECIFICALLY DISCLAIMS ANY REPRESENTATIONS, ENDORSEMENTS, GUARANTEES, OR WARRANTIES, EXPRESS OR IMPLIED, RELATED TO THE EVALUATION BOARD INCLUDING, BUT NOT LIMITED TO, THE IMPLIED WARRANTY OF MERCHANTABILITY, TITLE, FITNESS FOR A PARTICULAR PURPOSE OR NON-INFRINGEMENT OF INTELLECTUAL PROPERTY RIGHTS. IN NO EVENT WILL ADI AND ITS LICENSORS BE LIABLE FOR ANY INCIDENTAL, SPECIAL, INDIRECT, OR CONSEQUENTIAL DAMAGES RESULTING FROM CUSTOMER'S POSSESSION OR USE OF THE EVALUATION BOARD, INCLUDING BUT NOT LIMITED TO LOST PROFITS, DELAY COSTS, LABOR COSTS OR LOSS OF GOODWILL. ADI'S TOTAL LIABILITY FROM ANY AND ALL CAUSES SHALL BE LIMITED TO THE AMOUNT OF ONE HUNDRED US DOLLARS (\$100.00). EXPORT. Customer agrees that it will not directly or indirectly export the Evaluation Board to another country, and that it will comply with all applicable United States federal laws and regulations relating to exports. GOVERNING LAW. This Agreement shall be governed by and construed in accordance with the substantive laws of the Commonwealth of Massachusetts (excluding conflict of law rules). Any legal action regarding this Agreement will be heard in the state or federal courts having jurisdiction in Suffolk County, Massachusetts, and Customer hereby submits to the personal jurisdiction and venue of such courts. The United Nations Convention on Contracts for the International Sale of Goods shall not apply to this Agreement and is expressly disclaimed.

©2016 Analog Devices, Inc. All rights reserved. Trademarks and registered trademarks are the property of their respective owners.  
UG13268-0-5/16(0)



[www.analog.com](http://www.analog.com)