

## Description and Applications

The DML1007LDS is a single channel load switch with very low on-resistance in a small package. It contains an N-channel MOSFET for up to  $V_{BIAS}$ -1.5V input voltage operation and 6A current channel with 3.2V to 5.5V bias supply. The load switch is controlled by a low voltage control signal through ON pin.

- Portable Computers
- Ultrabooks
- Tablet PCs
- Set Top Boxed
- LCD TV
- Telecom/Networking/Datacom Equipment
- SSD
- Consumer Electronics

## Features and Benefits

- Low  $R_{DS(ON)}$  – Ensures On State Losses Are Minimized
- 0.8V to  $V_{BIAS}$ -1.5V Input Voltage Range
- 6A Continuous Current
- Low  $R_{DS(ON)}$  Internal NFETs  
8m $\Omega$  at  $V_{BIAS} = 5V$ ,  $V_{IN} = 1.05V$ ,  $T_A = +85^\circ C$
- 35 $\mu A$  Low Quiescent Current
- 200 $\mu s$  Turn On Rise Time
- 3.2V to 5.5V Bias Voltage
- Integrated Quick Output Discharge Resistor
- **Totally Lead-Free & Fully RoHS Compliant (Notes 1 & 2)**
- **Halogen and Antimony Free. "Green" Device (Note 3)**

V-DFN3030-8 (Type R)



Top View

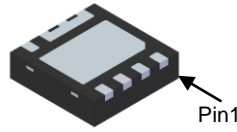

Bottom View

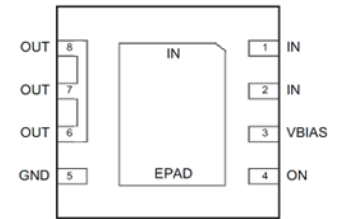
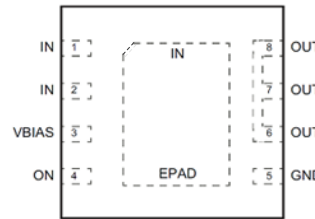

## Ordering Information (Note 4)

Part Number	Case	Packaging
DML1007LDS-7	V-DFN3030-8 (Type R)	3000/Tape & Reel

- Notes:
1. No purposely added lead. Fully EU Directive 2002/95/EC (RoHS) & 2011/65/EU (RoHS 2) compliant.
  2. See [http://www.diodes.com/quality/lead\\_free.html](http://www.diodes.com/quality/lead_free.html) for more information about Diodes Incorporated's definitions of Halogen- and Antimony-free, "Green" and Lead-free.
  3. Halogen- and Antimony-free "Green" products are defined as those which contain <900ppm bromine, <900ppm chlorine (<1500ppm total Br + Cl) and <1000ppm antimony compounds.
  4. For packaging details, go to our website at <http://www.diodes.com/products/packages.html>.

## Pin Description

Pin Number	Pin Name	Pin Function
1, 2, EPAD	IN	Load Switch Input. Bypass capacitor is recommended to minimize input voltage dip. Recommended voltage range of this pin is 0.8V to $V_{BIAS}$ -1.5V to obtain optimal $R_{ON}$ .
3	VBIAS	Bias Voltage. Power supply input for the device. Recommended voltage range is 3.2V to 5.5V.
4	ON	Enable Input. Load switch is on when ON is pulled high. Load switch is off when ON is pulled low. Do not leave floating.
5	GND	Ground.
6, 7, 8	OUT	Load switch output.

## Marking Information

V-DFN3030-8 (Type R)

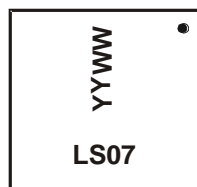

LS07= Product Type Marking Code  
 YYWW = Date Code Marking  
 YY = Last Two Digits of Year (ex: 16 = 2016)  
 WW = Week Code (01 to 53)

**Typical Application**

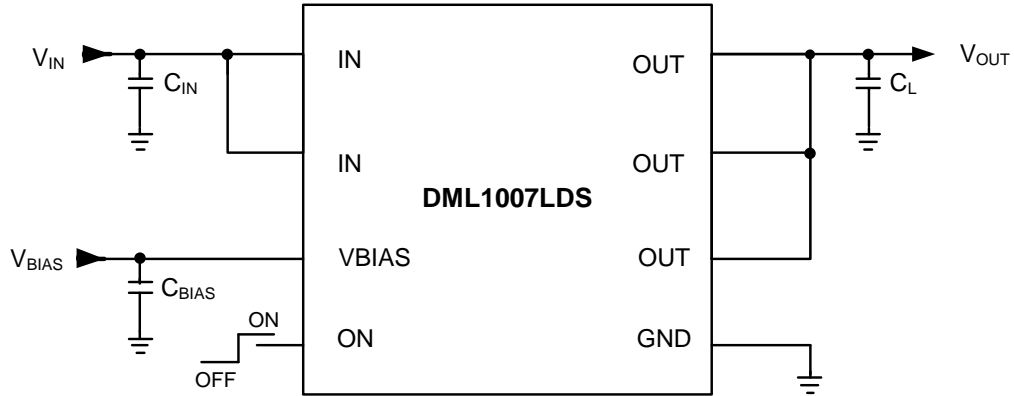

**Functional Block Diagram**

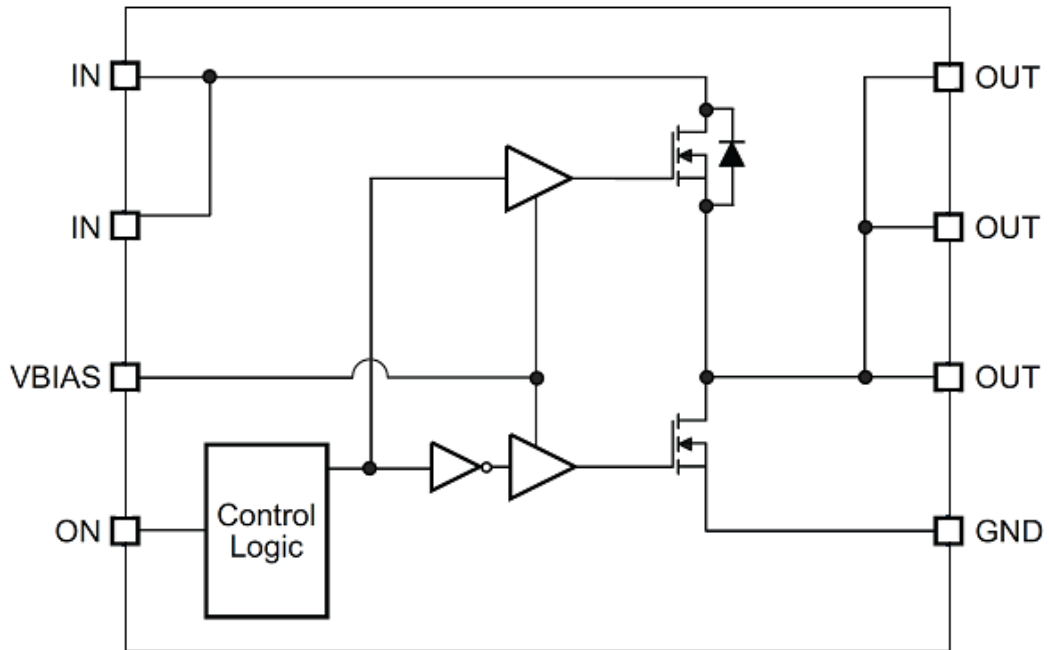

### Absolute Maximum Ratings

Parameter	Rating
IN, ON, VBIAS, OUT to GND	-0.3V to 6V
Junction Temperature (T <sub>J</sub> )	+150°C
Storage Temperature (T <sub>S</sub> )	-65°C to +150°C
ESD Rating HBM/CDM	2kV/1kV

### Maximum Operating Ratings

Parameter	Rating
Supply Voltage (V <sub>IN</sub> )	V <sub>BIAS</sub> -1.5V
Ambient Temperature (T <sub>A</sub> )	-40°C to +85°C
Package Thermal Resistance (θ <sub>JC</sub> )	8°C/W
Package Thermal Resistance (θ <sub>JA</sub> )	60°C/W

### Electrical Characteristics (T<sub>A</sub> = +25°C, V<sub>BIAS</sub> = 5V, V<sub>IN</sub> = 1.05V, unless otherwise specified.)

Symbol	Parameter	Conditions	Min	Typ	Max	Unit
V <sub>IN</sub>	IN Supply Voltage	V <sub>ON</sub> = 5V	0.8	1.05	V <sub>BIAS</sub> -1.5	V
V <sub>BIAS</sub>	VBIAS Supply Voltage	—	3.2	5	5.5	V
I <sub>D</sub>	Maximum Continuous Current	V <sub>ON</sub> = 5V	—	6	—	A
I <sub>PLS</sub>	Maximum Pulsed Switch Current	V <sub>IN</sub> = V <sub>ON</sub> = 5V Pulse < 300μs, 2% Duty Cycle	—	12	—	A
I <sub>Q</sub>	Quiescent Supply Current of VBIAS	I <sub>OUT</sub> = 0V, V <sub>ON</sub> = 5V	—	35	—	μA
I <sub>OFF</sub>	VBIAS Shutdown Supply Current	V <sub>ON</sub> = 0V, V <sub>OUT</sub> = 0V	—	—	2	μA
I <sub>INOFF</sub>	IN Shutdown Supply Current	V <sub>ON</sub> = 0V, V <sub>OUT</sub> = 0V	—	—	2	μA
I <sub>ON</sub>	ON Leakage Current	V <sub>ON</sub> = 5V	—	—	1	μA
V <sub>ONH</sub>	ON High Level Voltage	—	1.2	—	—	V
V <sub>ONL</sub>	ON Low Level Voltage	—	—	—	0.5	V
<b>Switching ON Resistance</b>						
R <sub>ON</sub>	Switch ON-State Resistance	I <sub>OUT</sub> = -200mA, V <sub>ON</sub> = 5V, V <sub>BIAS</sub> = 5V	—	—	8	mΩ
		I <sub>OUT</sub> = -200mA, V <sub>ON</sub> = 5V, V <sub>BIAS</sub> = 3.3V	—	—	10	mΩ
R <sub>PD</sub>	Output Pull-Down Resistance	I <sub>OUT</sub> = 15mA, V <sub>ON</sub> = 0V	—	—	200	Ω

### Switching Characteristics

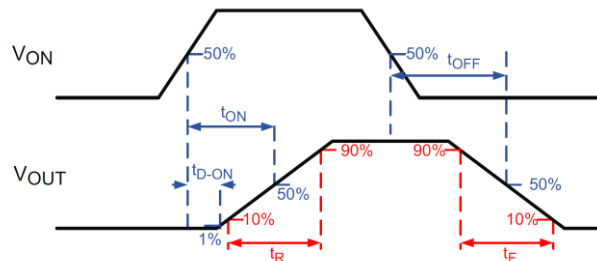

Test conditions: T<sub>A</sub> = +25°C, C<sub>IN</sub> = 1μF, C<sub>L</sub> = 0.1μF, R<sub>L</sub> = 10Ω (unless otherwise specified).

Symbol	Parameter	Min	Typ	Max	Unit
<b>V<sub>IN</sub> = 1.5V, V<sub>BIAS</sub> = V<sub>ON</sub> = 5V</b>					
t <sub>ON</sub>	Turn-ON Time	—	200	—	μs
t <sub>D-ON</sub>	Turn-ON Delay Time	—	100	—	
t <sub>R</sub>	Turn-ON Rise Time	—	150	—	
t <sub>OFF</sub>	Turn-OFF Time	—	1	—	
t <sub>F</sub>	Turn-OFF Fall Time	—	1	—	
<b>V<sub>IN</sub> = 1.05V, V<sub>BIAS</sub> = V<sub>ON</sub> = 5V</b>					
t <sub>ON</sub>	Turn-ON Time	—	200	—	μs
t <sub>D-ON</sub>	Turn-ON Delay Time	—	100	—	
t <sub>R</sub>	Turn-ON Rise Time	—	150	—	
t <sub>OFF</sub>	Turn-OFF Time	—	0.7	—	
t <sub>F</sub>	Turn-OFF Fall Time	—	0.7	—	

**Typical Characteristics**

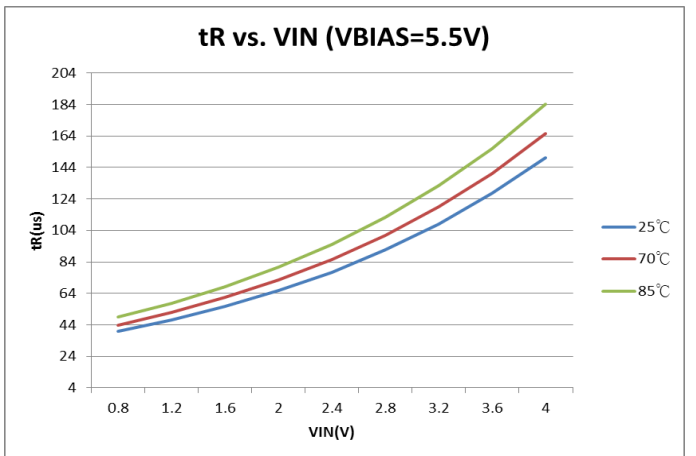
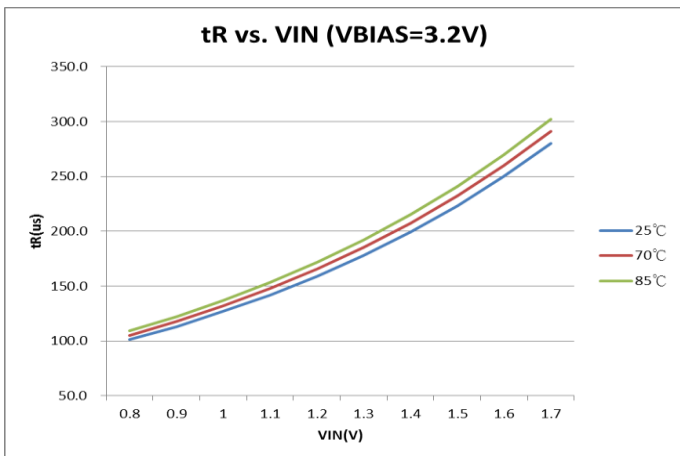
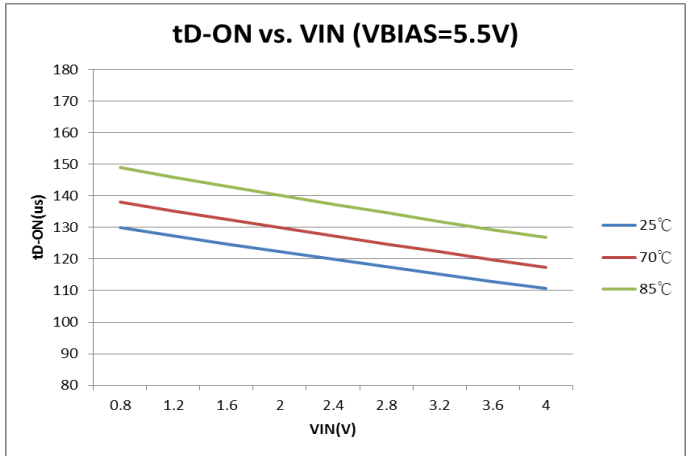
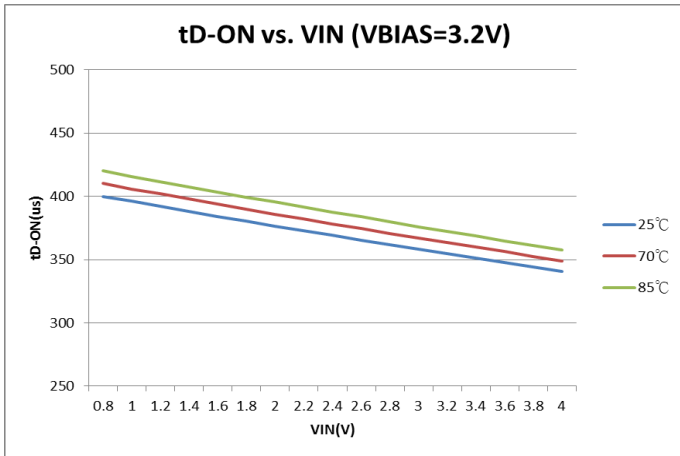
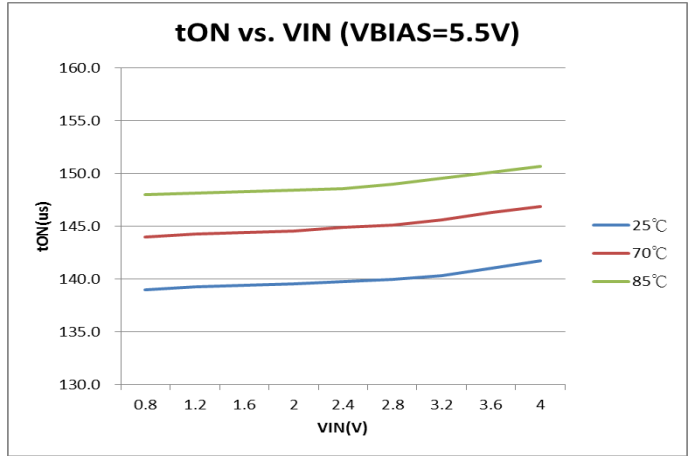
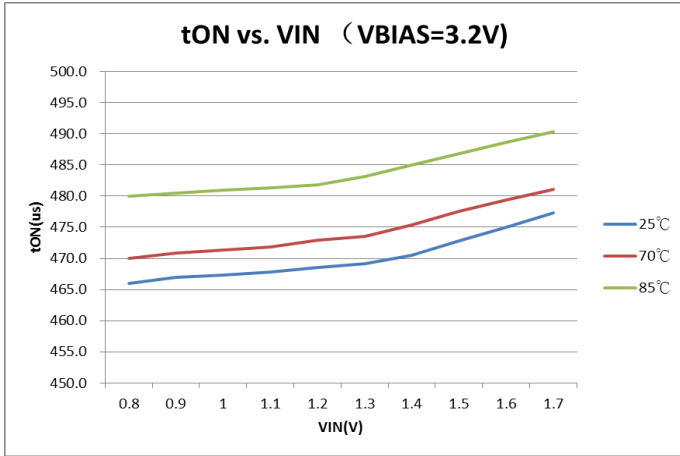

**Typical Characteristics (Cont.)**

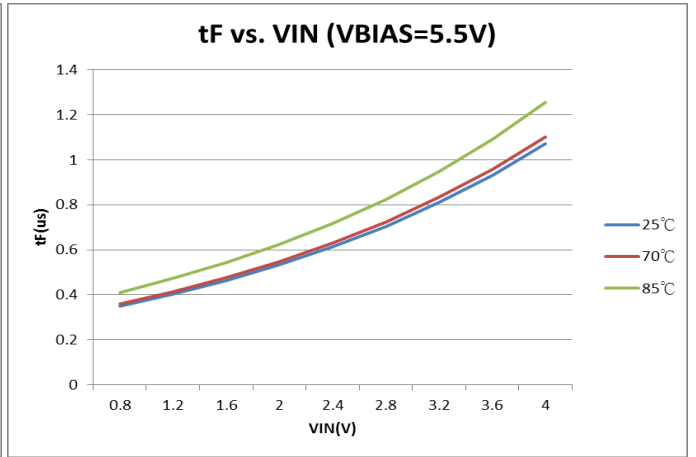
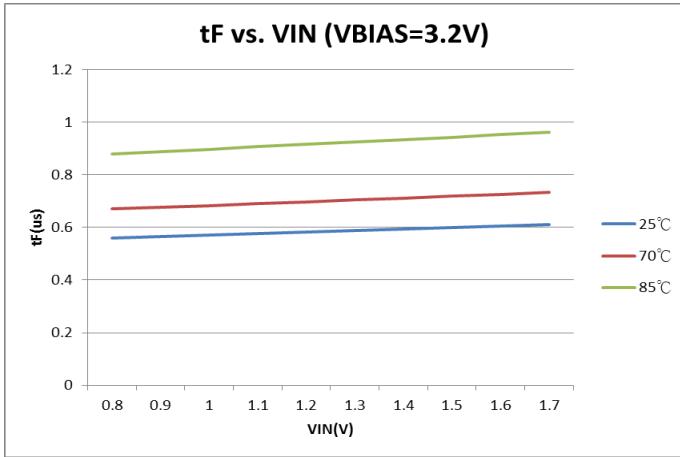
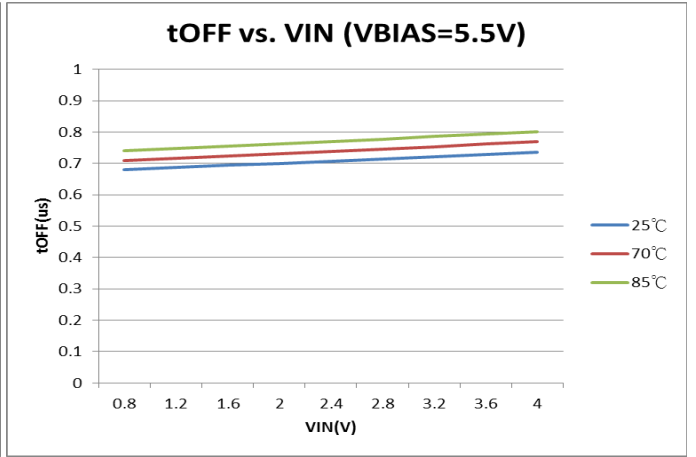
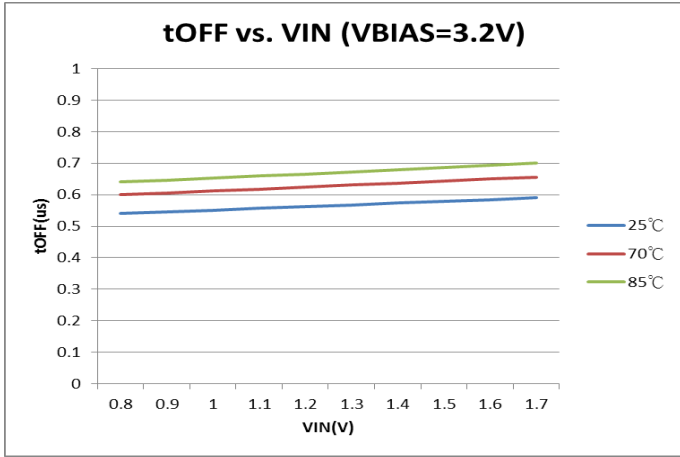

**Functional Characteristics**

**Turn-ON & Turn-ON Rise Time**

$V_{INX}=1.05V$ ,  $V_{BIAS}=5V$ ,  $C_{IN}=1\mu F$ ,  $C_L=0.1\mu F$ ,  $R_L=10\Omega$

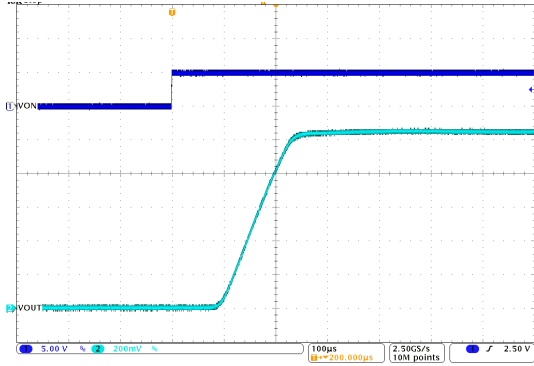

$V_{ON}$   
(5V/div)  
 $V_{OUT}$   
(200mV/div)

**Turn-ON & Turn-ON Rise Time**

$V_{INX}=1.05V$ ,  $V_{BIAS}=3.2V$ ,  $C_{IN}=1\mu F$ ,  $C_L=0.1\mu F$ ,  $R_L=10\Omega$

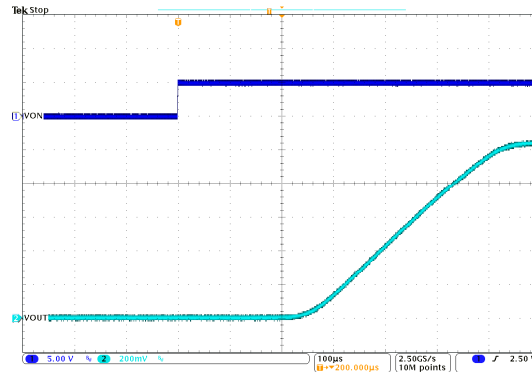

$V_{ON}$   
(5V/div)  
 $V_{OUT}$   
(200mV/div)

**Turn-OFF & Turn-OFF FALL Time**

$V_{INX}=1.05V$ ,  $V_{BIAS}=5V$ ,  $C_{IN}=1\mu F$ ,  $C_L=0.1\mu F$ ,  $R_L=10\Omega$

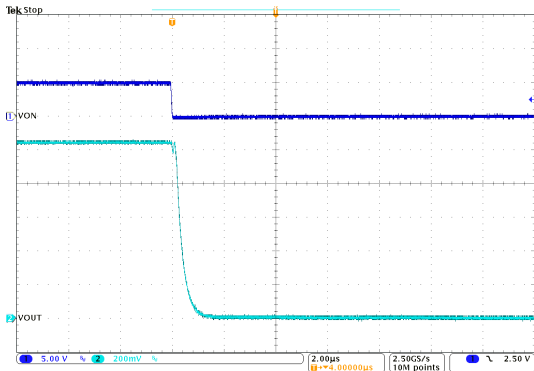

$V_{ON}$   
(5V/div)  
 $V_{OUT}$   
(200mV/div)

**Turn-OFF & Turn-OFF FALL Time**

$V_{INX}=1.05V$ ,  $V_{BIAS}=3.2V$ ,  $C_{IN}=1\mu F$ ,  $C_L=0.1\mu F$ ,  $R_L=10\Omega$

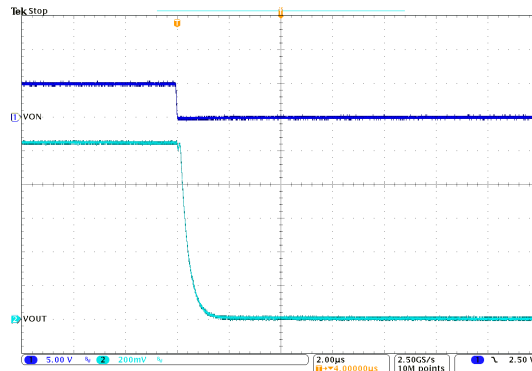

$V_{ON}$   
(5V/div)  
 $V_{OUT}$   
(200mV/div)

**Turn-ON & Turn-OFF at  $I_{OUT} = -10A$**

$V_{INX}=1.05V$ ,  $V_{BIAS}=5V$ ,  $C_{IN}=1\mu F$ ,  $C_L=0.1\mu F$ ,  $R_L=0.1\Omega$

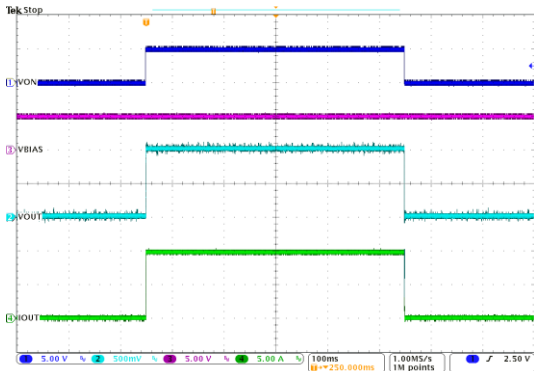

$V_{ON}$   
(5V/div)  
 $V_{BIAS}$   
(5V/div)  
 $V_{OUT}$   
(500mV/div)  
 $I_{OUT}$   
(5A/div)

**Turn-ON & Turn-OFF at  $I_{OUT} = -10A$**

$V_{INX}=1.05V$ ,  $V_{BIAS}=3.2V$ ,  $C_{IN}=1\mu F$ ,  $C_L=0.1\mu F$ ,  $R_L=0.1\Omega$

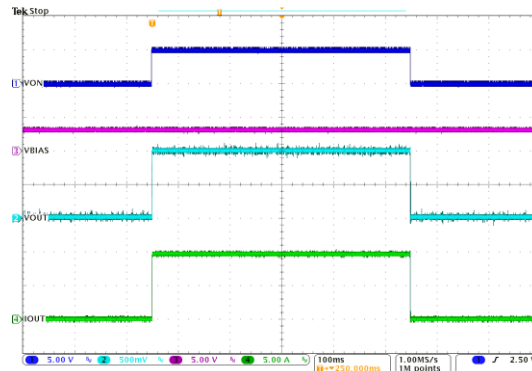

$V_{ON}$   
(5V/div)  
 $V_{BIAS}$   
(5V/div)  
 $V_{OUT}$   
(500mV/div)  
 $I_{OUT}$   
(5A/div)

## Detailed Description

### ON/OFF Control

The DML1007LDS is enabled when the ON pin is on active high with 1.2V or above voltage. The device is disabled when the ON pin voltage is 0.5V or lower. The EN input is compatible with both TTL and CMOS logic.

### VBIAS Voltage Range

For optimal on-resistance of load switch, make sure  $V_{IN} \leq 1.5V + V_{BIAS}$  and  $V_{BIAS}$  is within the voltage range from 3.2V to 5.5V. On-resistance of load switch will be higher if  $V_{IN} + 1.5V > V_{BIAS}$ . Resistance curves of a typical sample device at different  $V_{BIAS} = V_{IN}$  at  $I_{OUT} = -200mA$  are shown as below.

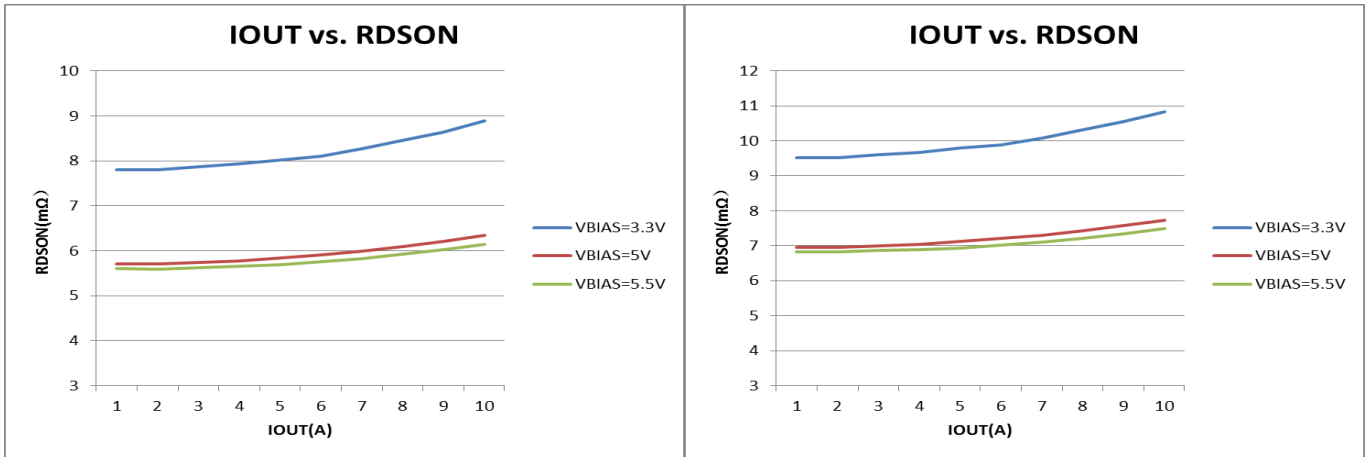

## Applications Information

The basic DML1007LDS application circuit is shown in the second page. Component selection is explained below.

### Input Capacitor

A capacitor of 10μF or higher value is recommended to be placed close to the IN pins of DML1007LDS. This capacitor can reduce the voltage drop caused by the in-rush current during the turn-on transient of the load switch. A higher value capacitor can be used to further reduce the voltage drop during high-current application.

### Output Capacitor

A capacitor of 0.1μF or higher value is recommended to be placed between the OUT pins and GND. The switching times are affected by the capacitance. A larger capacitor makes the initial turn-on transient smoother. This capacitor must be large enough to supply a fast transient load in order to prevent the output from dropping.

### Thermal Considerations

To ensure proper operation, the maximum junction temperature of the DML1007LDS should not exceed +150°C. Several factors attribute to the junction temperature rise: load current, MOSFET on-resistance, junction-to-ambient thermal resistance, and ambient temperature. The maximum load current can be determined by:

$$I_{LOAD(MAX)} = \sqrt{\frac{T_{J(MAX)} - T_C}{\Theta_{JC} \times R_{DS(ON)}}$$

It is noted that the maximum continuous load current is 6A.

### Layout Guidelines

Good PCB is important for improving the thermal performance of DML1007LDS. Place the input and output bypass capacitors close to the IN and OUT pins. The input and output PCB traces should be as wide as possible for the given PCB space. Use a ground plane to enhance the power dissipation capability of the device.

**Package Outline Dimensions**

Please see <http://www.diodes.com/package-outlines.html> for the latest version.

**V-DFN3030-8 (Type R)**

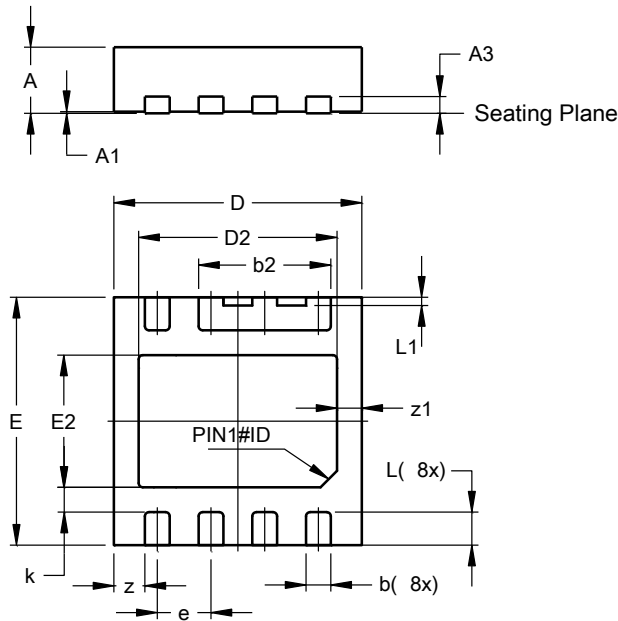

V-DFN3030-8 (Type R)			
Dim	Min	Max	Typ
A	0.77	0.83	0.80
A1	0.00	0.05	0.03
A3	--	--	0.203
b	0.25	0.35	0.30
b2	1.55	1.65	1.60
D	2.95	3.05	3.00
D2	2.30	2.50	2.40
E	2.95	3.05	3.00
E2	1.50	1.70	1.60
e	0.65 BSC		
k	--	--	0.30
L	0.35	0.45	0.40
L1	0.05	0.15	0.10
z	--	--	0.375
z1	--	--	0.30
All Dimensions in mm			

**Suggested Pad Layout**

Please see <http://www.diodes.com/package-outlines.html> for the latest version.

**V-DFN3030-8 (Type R)**

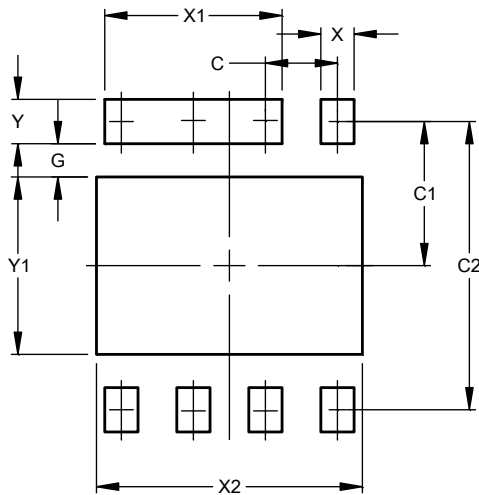

Dimensions	Value (in mm)
C	0.65
C1	1.30
C2	2.60
G	0.30
X	0.30
X1	1.60
X2	2.40
Y	0.40
Y1	1.60



**Surface Mount Reel Specifications** (All dimensions in mm.)

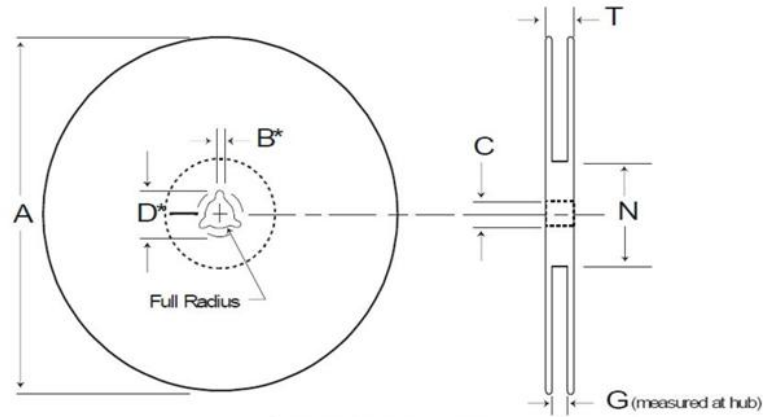

\* Drive spokes optional. If used, dimensions with asterisks apply.

Tape Size	A Max	B* Max	C	D* Max	N Min	G	T Max
8mm	330 ±2	2.0 +0.5 -0	13 +0.5 -0.2	20.5 ±0.2	100 ±2	8.4 +2.0 -0.0	14.4
	178 ±2	2.0 +0.5 -0	13 +0.5 -0.2	20.5 ±0.2	55 ±5	8.4 +1.5 -0.0	14.4

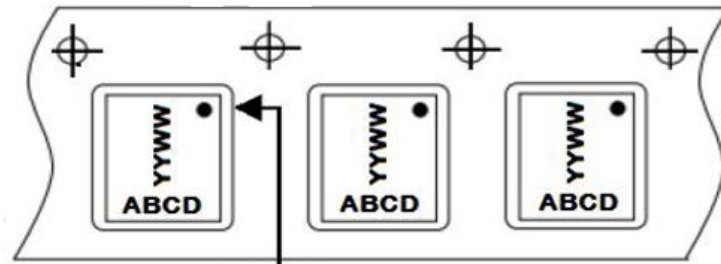

Pin 1

**Tape Leader and Trailer**

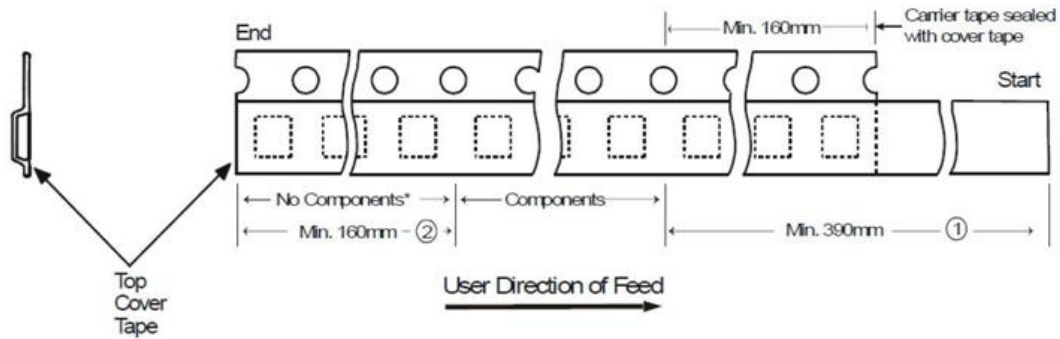

- Notes:
5. There shall be a leader of 230mm [9.05 inches] minimum which may consist of carrier and/or cover tape or a start tape followed by a minimum of 160mm [6.30 inches] of empty carrier tape sealed with cover tape.
  6. There shall be a trailer of 160mm [6.30 inches] minimum of empty carrier tape sealed with cover tape. The entire carrier tape must release from the reel hub as the last portion of the tape unwinds from the reel without damage to the carrier tape and the remaining components in the cavities.

**IMPORTANT NOTICE**

DIODES INCORPORATED MAKES NO WARRANTY OF ANY KIND, EXPRESS OR IMPLIED, WITH REGARDS TO THIS DOCUMENT, INCLUDING, BUT NOT LIMITED TO, THE IMPLIED WARRANTIES OF MERCHANTABILITY AND FITNESS FOR A PARTICULAR PURPOSE (AND THEIR EQUIVALENTS UNDER THE LAWS OF ANY JURISDICTION).

Diodes Incorporated and its subsidiaries reserve the right to make modifications, enhancements, improvements, corrections or other changes without further notice to this document and any product described herein. Diodes Incorporated does not assume any liability arising out of the application or use of this document or any product described herein; neither does Diodes Incorporated convey any license under its patent or trademark rights, nor the rights of others. Any Customer or user of this document or products described herein in such applications shall assume all risks of such use and will agree to hold Diodes Incorporated and all the companies whose products are represented on Diodes Incorporated website, harmless against all damages.

Diodes Incorporated does not warrant or accept any liability whatsoever in respect of any products purchased through unauthorized sales channel. Should Customers purchase or use Diodes Incorporated products for any unintended or unauthorized application, Customers shall indemnify and hold Diodes Incorporated and its representatives harmless against all claims, damages, expenses, and attorney fees arising out of, directly or indirectly, any claim of personal injury or death associated with such unintended or unauthorized application.

Products described herein may be covered by one or more United States, international or foreign patents pending. Product names and markings noted herein may also be covered by one or more United States, international or foreign trademarks.

This document is written in English but may be translated into multiple languages for reference. Only the English version of this document is the final and determinative format released by Diodes Incorporated.

**LIFE SUPPORT**

Diodes Incorporated products are specifically not authorized for use as critical components in life support devices or systems without the express written approval of the Chief Executive Officer of Diodes Incorporated. As used herein:

A. Life support devices or systems are devices or systems which:

1. are intended to implant into the body, or
2. support or sustain life and whose failure to perform when properly used in accordance with instructions for use provided in the labeling can be reasonably expected to result in significant injury to the user.

B. A critical component is any component in a life support device or system whose failure to perform can be reasonably expected to cause the failure of the life support device or to affect its safety or effectiveness.

Customers represent that they have all necessary expertise in the safety and regulatory ramifications of their life support devices or systems, and acknowledge and agree that they are solely responsible for all legal, regulatory and safety-related requirements concerning their products and any use of Diodes Incorporated products in such safety-critical, life support devices or systems, notwithstanding any devices- or systems-related information or support that may be provided by Diodes Incorporated. Further, Customers must fully indemnify Diodes Incorporated and its representatives against any damages arising out of the use of Diodes Incorporated products in such safety-critical, life support devices or systems.

Copyright © 2016, Diodes Incorporated

[www.diodes.com](http://www.diodes.com)