

Specifications (measured at $T_A = 25^\circ\text{C}$, nominal input voltage, full load and after warm-up)

BASIC CHARACTERISTICS				
Parameter	Condition	Min.	Typ.	Max.
Operating Frequency	full load		67kHz	
Efficiency				see Selection Guide
Minimum Load	RAC04-0512DC/277(-E) All Others		$\pm 5\% / \pm 0\%$ 0%	
Output Ripple and Noise ⁽⁴⁾			200mVp-p	

Notes:

Note4: Ripple and Noise is measured at 20MHz bandwidth and with a 47 μF low-ESR electrolytic capacitor in parallel with a 0.1 μF ceramic capacitor across output.

Efficiency vs. Load

RAC04-3.3SC/277 (-E)

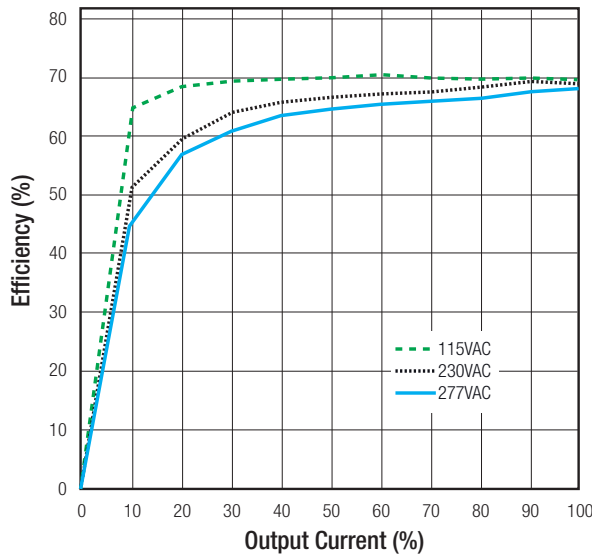

RAC04-05SC/277 (-E)

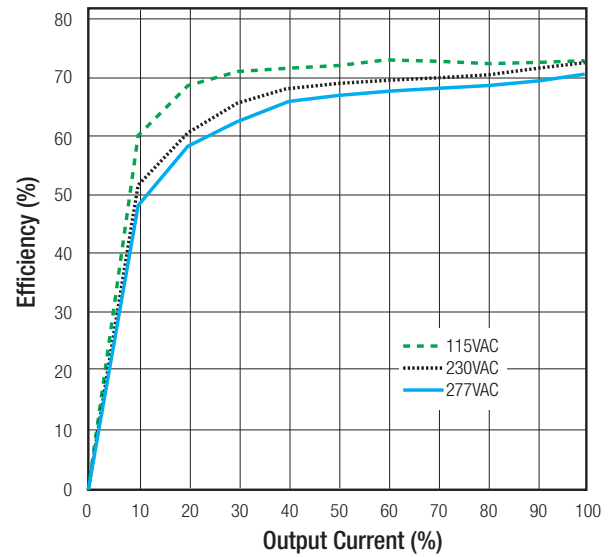

RAC04-12SC/277 (-E)

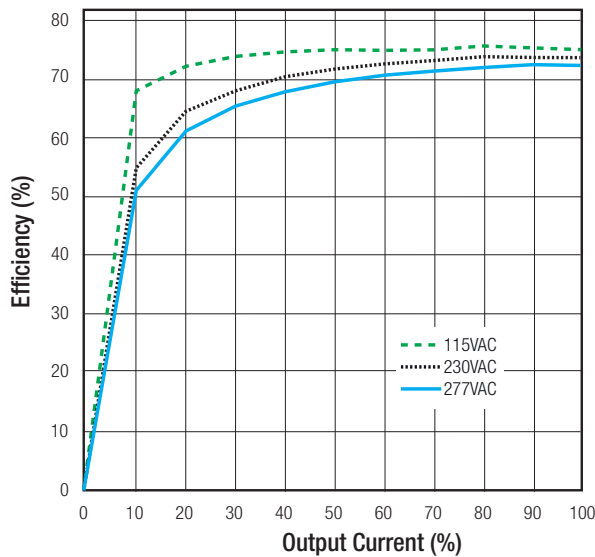

RAC04-15SC/277 (-E)

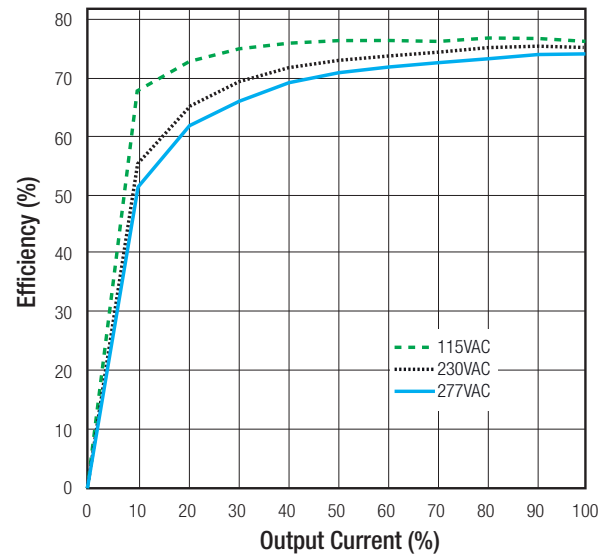

continued on next page

Specifications (measured at $T_A=25^{\circ}\text{C}$, nominal input voltage, full load and after warm-up)

Efficiency vs. Load

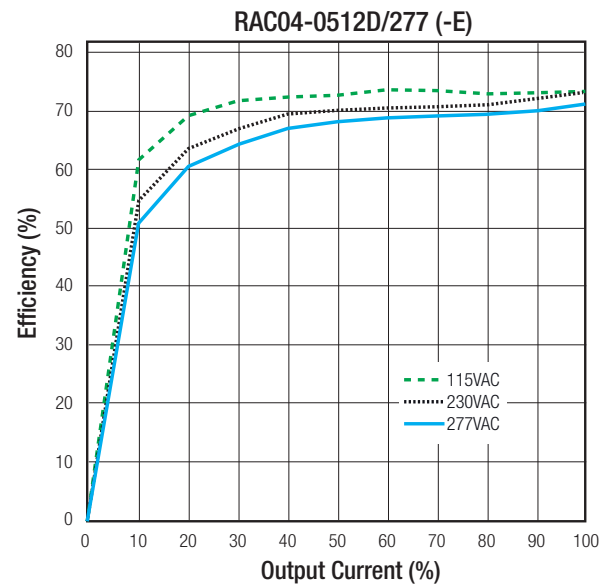
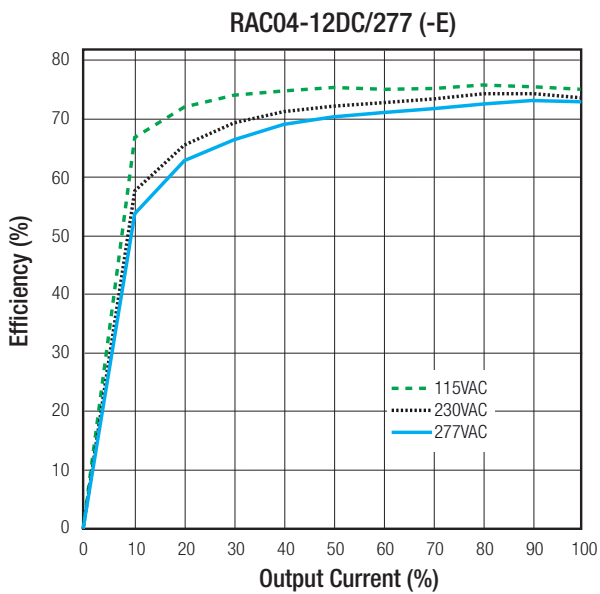
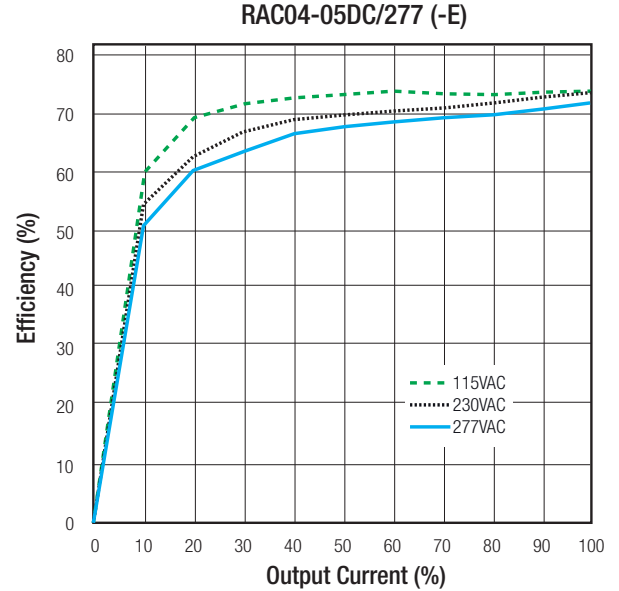
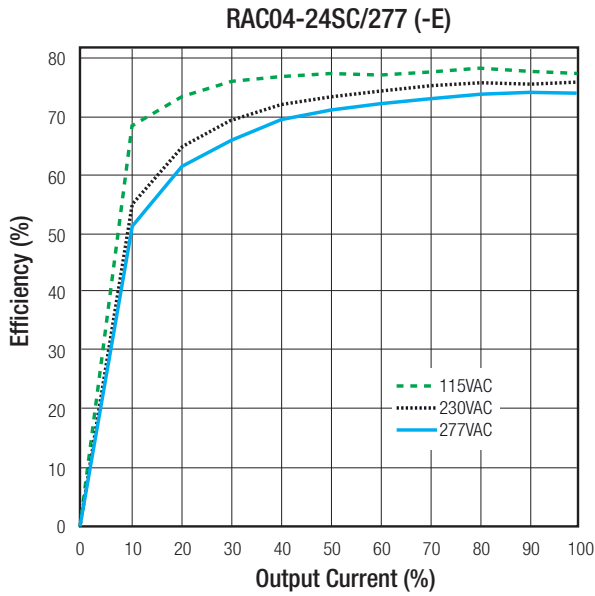

REGULATIONS

Parameter	Condition	Value
Output Voltage Tolerance	RAC04-0512DC/277(-E)	$\pm 2\%$ / $\pm 10\%$ typ.
	All Others	$\pm 2\%$ typ.
Line Voltage Regulation	90-305VAC, RAC04-0512DC/277(-E)	$\pm 0.2\%$ / $\pm 1\%$ typ.
	90-305VAC, All Others	$\pm 0.2\%$ typ.
Load Voltage Regulation (5V minimum load 5% @12V full load)	3.3V, 5V	$\pm 1\%$ typ.
	RAC04-0512DC/277(-E)	$\pm 1\%$ / $\pm 5\%$ typ.
	All Others	$\pm 0.5\%$ typ.

Specifications (measured at $T_A = 25^\circ\text{C}$, nominal input voltage, full load and after warm-up)

PROTECTIONS

Parameter	Type	Value
Short Circuit Protection (SCP)		automatic recovery
Isolation Voltage	I/P to O/P	3.75kVAC / 1 Minute
Isolation Resistance		100M Ω min.
Leakage Current	277VAC / 50Hz	0.25mA max.

Application Note

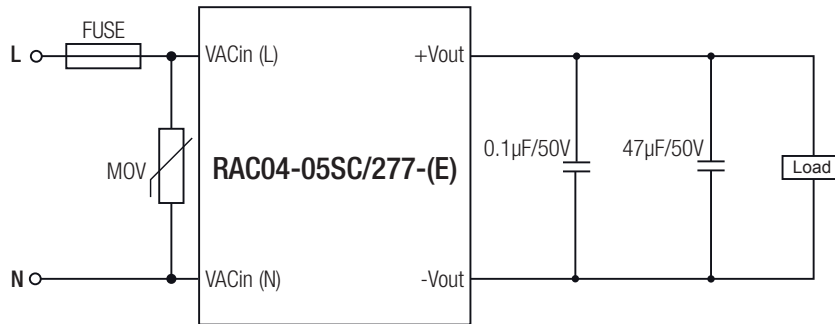

Notes:

Note5: An external input fuse is recommended: T1A slow blow type

Note6: To measure the output ripple and noise short runs by 0.1 $\mu\text{F}/50\text{V}$ & 47 $\mu\text{F}/50\text{V}$ @20MHz, nominal input and full load.

Note7: An external MOV is required for 230VAC operation. (MOV model: shall comply with IEC 61051-2, e.g. Epcos S14 Series.)

ENVIRONMENTAL

Parameter	Condition	Value
Operating Temperature Range	230VAC, with derating (see graph) with suffix "-E", with derating (see graph)	-25 $^\circ\text{C}$ to +80 $^\circ\text{C}$ -40 $^\circ\text{C}$ to +80 $^\circ\text{C}$
Maximum Case Temperature		90 $^\circ\text{C}$
Thermal Impedance		10 $^\circ\text{C}/\text{W}$
Humidity	non-condensing	95%, RH max.
MTBF ⁽⁶⁾	MIL-HDBK-217F, +25 $^\circ\text{C}$	500 x 10 ³ hours

Derating Graph

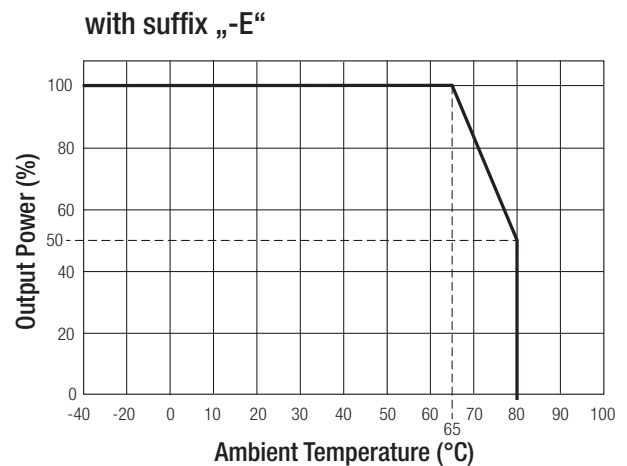
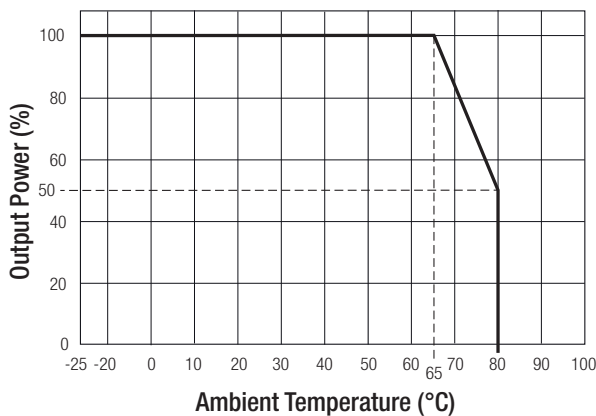

Specifications (measured at $T_A=25^\circ\text{C}$, nominal input voltage, full load and after warm-up)

SAFETY AND CERTIFICATIONS

Certificate Type	Report / File Number	Standard
CB Report	1310055-1-CB-M1	IEC-60950-1, 2nd Edition
EN General Safety	SPCLVD1310055-1-M1	EN-60950-1, 2nd Edition
UL General Safety	E224736-X1-A18	UL-60950-1, 2nd Edition, 2011
Canada General Safety		CAN/CSA C22.2 No. 60950-1-07, 2nd Edition, 2011

Certificate Type (Environmental)	Report / File Number	Standard / Criterion
EMI Standard	Report: T160225D10-E	EN55022, Class B EN55024
ESD	Report: T160225D10-E	EN61000-4-2, Criteria B
Radiated Immunity		EN61000-4-3, Criteria A
Fast Transient		EN61000-4-4, Criteria B
Surge		EN61000-4-5, Criteria B
Conducted Immunity		EN61000-4-6, Criteria A
Voltage dips and variations		EN61000-4-8, Criteria A
Harmonic Current Emissions		EN-61000-3-2
Voltage flicker		EN-61000-3-3
Vibration		MIL-STD-202G
Over Voltage Category		OVC II

DIMENSION and PHYSICAL CHARACTERISTICS

Parameter	Type	Value
Case Material		UL94V-0, black plastic
Potting Material		UL94V-0, Silicone
Package Dimension (LxWxH)		36.7 x 27.2 x 17.1mm
Package Weight		41g typ.

Dimension Drawing (mm)

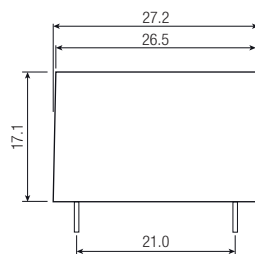
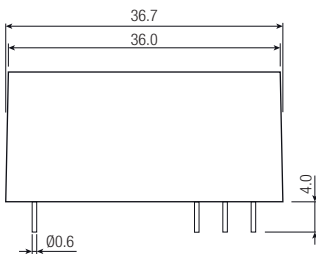
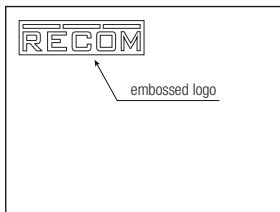
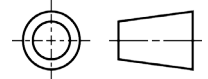

Pin Connections

Pin #	Single	Dual	Dual (asymmetric)
2	+VDC out	+VDC out	+5V
3	-VDC out	Com	Com
4	NC	-VDC out	+12V
5	VAC in (L)	VAC in (L)	VAC in (L)
6	VAC in (N)	VAC in (N)	VAC in (N)
7	NC	NC	NC

NC= no connection
Tolerance: xx.x= $\pm 0.5\text{mm}$
xx.xx= $\pm 0.35\text{mm}$
Pin width: $\pm 0.05\text{mm}$

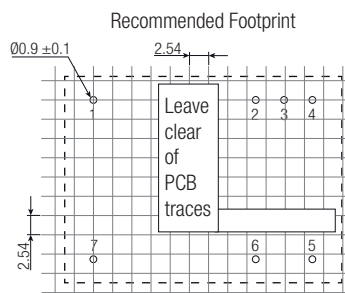
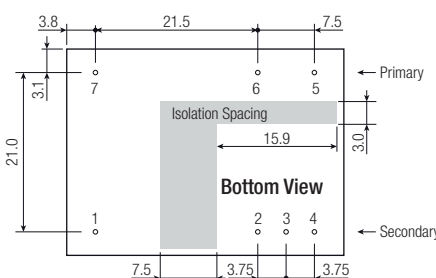

Specifications (measured at $T_A = 25^\circ\text{C}$, nominal input voltage, full load and after warm-up)

PACKAGING INFORMATION		
Parameter	Type	Value
Packaging Dimension (LxWxH)	Tube	520 x 32 x 27mm
Packaging Quantity		12 pcs.
Storage Temperature Range		-40°C to +100°C