

EVB-USB3300 User Manual

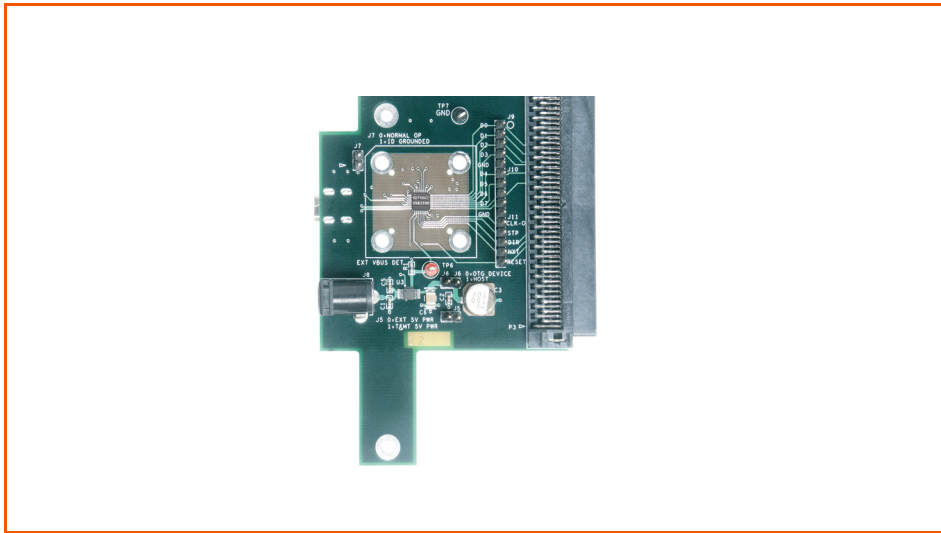

Copyright © 2006 SMSC or its subsidiaries. All rights reserved.

SMSC is a registered trademark of Standard Microsystems Corporation ("SMSC").

The information contained herein is proprietary to SMSC and shall be used solely in accordance with the agreement pursuant to which it is provided. Although the information is believed to be accurate, no responsibility is assumed for inaccuracies. SMSC reserves the right to make changes to this document and to specifications and product descriptions at any time without notice. Neither the provision of this information nor the sale of the described semiconductor devices conveys any licenses under any patent rights or other intellectual property rights of SMSC or others unless specifically specified otherwise. The product may contain design defects or errors known as anomalies, including but not necessarily limited to any which may be identified in this document, which may cause the product to deviate from published specifications. SMSC products are not designed, intended, authorized or warranted for use in any life support or other application where product failure could cause or contribute to personal injury or severe property damage. Any and all such uses without prior written approval of an officer of SMSC will be fully at the risk of the customer. SMSC is a registered trademark of Standard Microsystems Corporation ("SMSC").

SMSC DISCLAIMS AND EXCLUDES ANY AND ALL WARRANTIES, INCLUDING WITHOUT LIMITATION ANY AND ALL IMPLIED WARRANTIES OF MERCHANTABILITY, FITNESS FOR A PARTICULAR PURPOSE, TITLE, AND AGAINST INFRINGEMENT AND THE LIKE, AND ANY AND ALL WARRANTIES ARISING FROM ANY COURSE OF DEALING OR USAGE OF TRADE. IN NO EVENT SHALL SMSC BE LIABLE FOR ANY DIRECT, INCIDENTAL, INDIRECT, SPECIAL, PUNITIVE, OR CONSEQUENTIAL DAMAGES; OR FOR LOST DATA, PROFITS, SAVINGS OR REV-ENUES OF ANY KIND; REGARDLESS OF THE FORM OF ACTION, WHETHER BASED ON CONTRACT; TORT; NEGLIGENCE OF SMSC OR OTHERS; STRICT LIABILITY; BREACH OF WARRANTY; OR OTHERWISE; WHETHER OR NOT ANY REMEDY OF BUYER IS HELD TO HAVE FAILED OF ITS ESSENTIAL PURPOSE, AND WHETHER OR NOT SMSC HAS BEEN ADVISED OF THE POSSIBILITY OF SUCH DAMAGES.

1 Introduction

The USB3300 features a ULPI interface to support systems operating as a USB Host, Device, or On-the-Go (OTG) system. The UTMI+ specification is built up in progressive levels as shown in [Figure 1](#). SMSC supplies a complete family of PHY products to meet the needs of many applications. The ULPI compliant USB3300 implements all of UTMI+ Level 3 with a 12 pin interface.

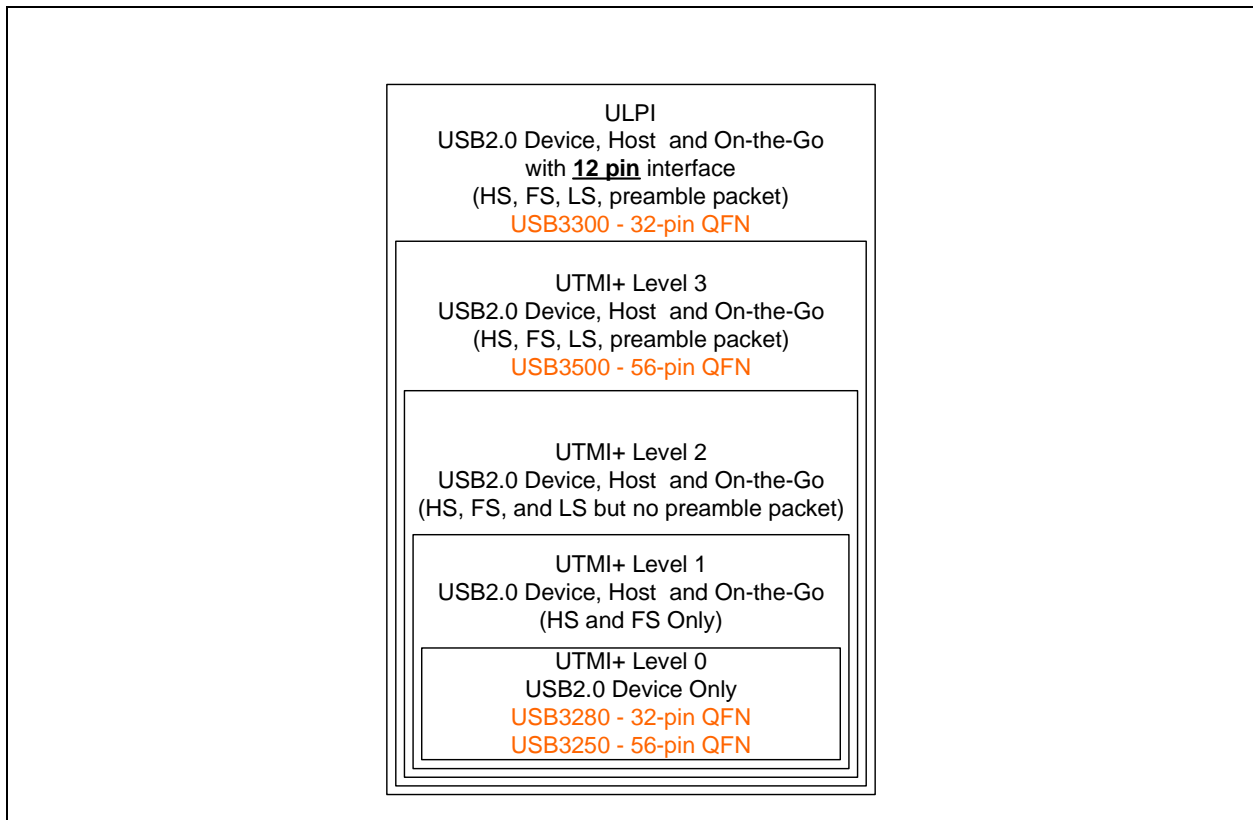

Figure 1 UTMI+ Levels

2 Overview

The EVB-USB3300 User Manual is a Daughter Card designed to plug into a user's test system using a T&MT connector. The card attaches to a USB link layer to create a USB Host, Device, or On-the-Go (OTG) system. The board edge connector meets the UTMI+ Low Pin Interface (ULPI) specification requirements for the T&MT connector. A link to the ULPI Working Group Page is available at www.ulpi.org. The board includes the USB300 packaged silicon and all associated external components.

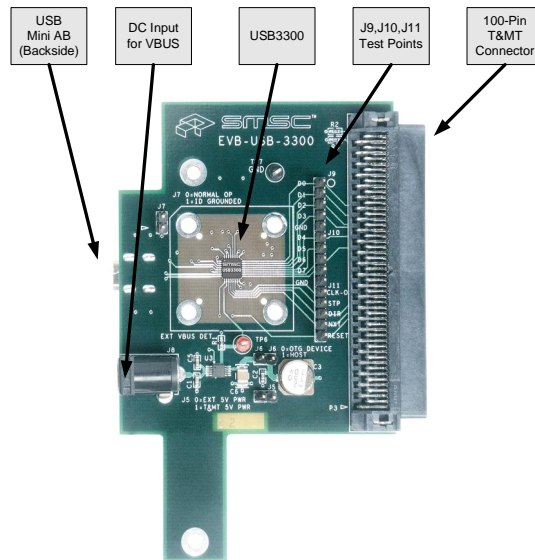

Figure 2 Top View of the EVB-USB3300 User Manual

2.1 Supplying VBUS Power

In host or OTG mode the EVB-USB3300 User Manual must provide 5 volts on V_{BUS} . The EVB-USB3300 User Manual includes a 5 volt switch that can connect 5 volts to V_{BUS} . The EVB-USB3300 User Manual 5 volt supply can come from either external power supplied at J4 or pin 28 of the T&MT connector when J5 is installed. If using the external power on J4, J5 should be removed.

The 5 volt switch is controlled by the CPEN signal from the USB3300. The CPEN state is controlled by ULPI registers in the USB3300. The 5 volt switch is backdrive protected and can handle 5 volts to ground from either direction. The switch does not provide protection from reverse currents. The user should take care to ensure the switch is off when V_{BUS} is being sourced by the USB cable.

In host mode, connector J6 can be installed to add capacitance to V_{BUS} .

2.2 3.3 Volt Power Supply

The EVB-USB3300 User Manual requires a 3.3 volt supply capable of providing 80mA of current to be present at the T&MT connector.

2.3 Edge Connector for Digital I/O

The T&MT edge connector is compliant to the UTMI specification. The 100 pin edge connector on the EVB-USB3300 User Manual is an AMP 2-557101-5, and it mates with the AMP 2-557100-5.

2.4 Crystal Oscillator

The 24 MHz crystal is connected to the internal oscillator of the USB3300. A PLL circuit in the USB3300 generates the 60MHz CLKOUT signal used by the link layer.

2.5 USB Connector

A standard Mini-AB connector is provided to attach a USB cable or connector. If only Host operation is desired, J7 may be installed to ground the ID pin.

2.6 VBUS Present Detection

The SIE must detect VBUS when the USB cable is attached. The USB connector VBUS signal is connected to the VBUS pin of the USB3300. The USB3300 includes all of the Vbus comparators required for OTG. Please refer to the USB3300 data sheet for a complete description.

The VBUS_in pin of the T&MT connector is not connected on the EVB-USB3300 User Manual.

2.7 UTMI Signal Test Points

The headers J9, J10 and J11 provide easy access to the ULPI signals, and each pin is labeled with a signal name as shown in [Figure 3](#) .

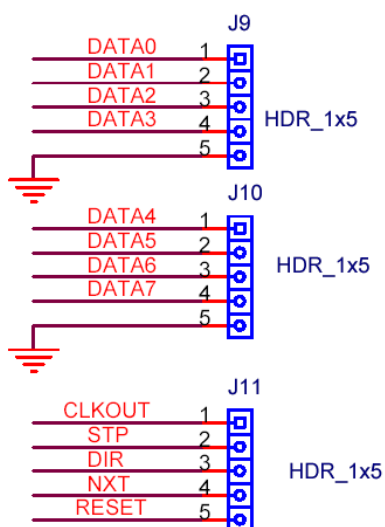

Figure 3 UTMI Signal Test Points

2.8 Block Diagram

The block diagram shows how the jumpers are used on the board.

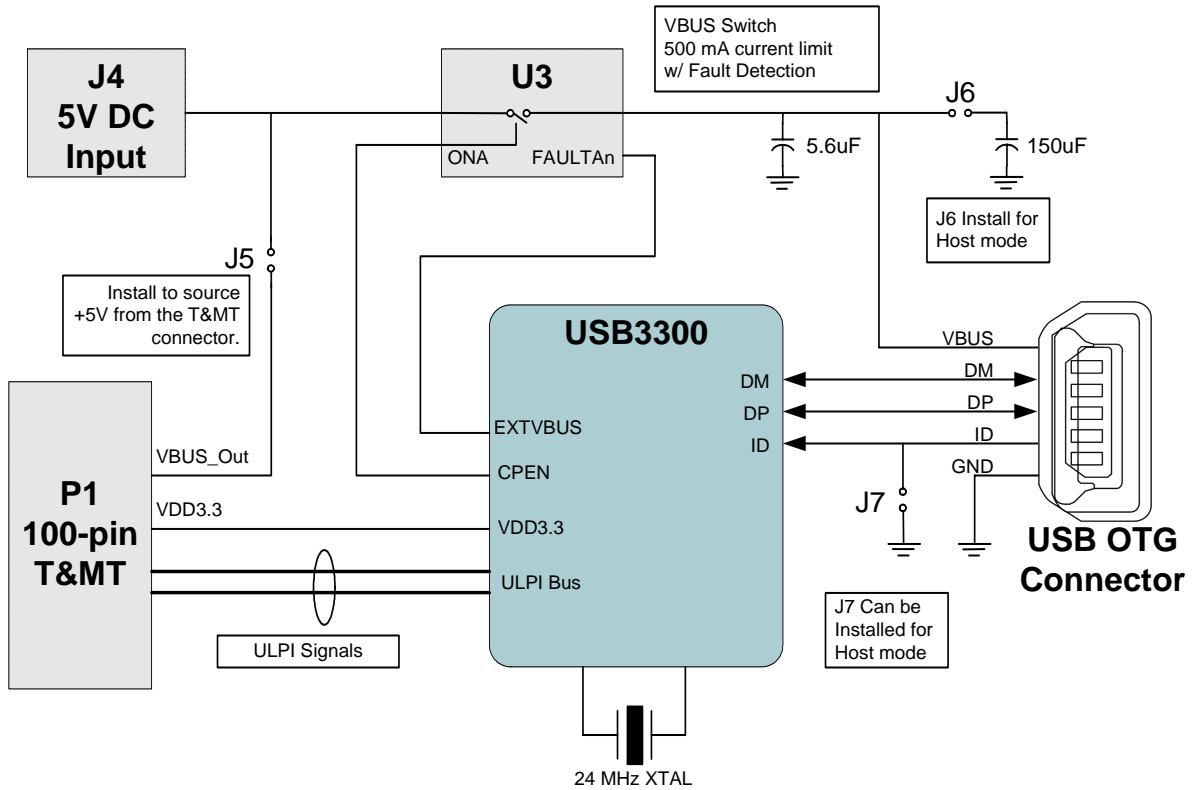

Figure 4 EVB-USB3300 User Manual Block Diagram

2.9 T&MT Connector Pinout

The T&MT connector is a 100 pin connector with a standard pinout for all ULPI PHY devices. The pin assignments are shown in [Table 1](#) below. The signals are defined in [Table 2](#) with a description relative to the EVB-USB3300 User Manual.

Table 1 T&MT Pin Assignments

PIN	DESCRIPTION	PIN	DESCRIPTION	PIN	DESCRIPTION	PIN	DESCRIPTION
1	GPIO0	26	GPIO1	51	GND	76	GND
2	GND	27	GND	52	sys_clk	77	Reserved
3	GPIO2	28	VBUS_out	53	GND	78	GPIO14
4	GND	29	GPIO3	54	GND	79	Reserved
5	GPIO4	30	Reserved	55	Reserved	80	GND
6	GPIO5	31	data7	56	GPIO6	81	VIO
7	GPIO7	32	GND	57	VDD	82	data6
8	VDD	33	data5	58	GPIO8	83	data4
9	GND	34	data3	59	Reserved	84	GND
10	Reserved	35	GND	60	Reserved	85	data2
11	GPIO9	36	data1	61	GPIO10	86	data0
12	GPIO11	37	Reserved	62	GND	87	VIO
13	GND	38	VIO	63	GPIO12	88	Reserved
14	Reserved	39	GND	64	Reserved	89	Reserved
15	SPKR_L	40	Reserved	65	GND	90	clock
16	VDD	41	Reserved	66	Reserved	91	Reserved
17	reset	42	Reserved	67	Reserved	92	GND
18	Reserved	43	GND	68	GND	93	Reserved
19	Reserved	44	Reserved	69	VDD	94	Reserved
20	Reserved	45	SPKR_MIC	70	dir	95	GND
21	GND	46	GND	71	nxt	96	stp
22	Reserved	47	VBUS_in	72	Reserved	97	Reserved
23	Reserved	48	Reserved	73	GND	98	Reserved
24	GND	49	dc_psnt_n	74	Reserved	99	Reserved
25	Reserved	50	GPIO13	75	Reserved	100	psu_shd_n

The location of data[7:0] is not the same as data[7:0] on the UTMI T&MT connector.

2.10 T&MT Pin Description

The signals are defined in [Table 2](#) with a description relative to the EVB-USB3300 User Manual

Table 2 T&MT PIN DESCRIPTION

NAME	DIRECTION RELATIVE TO EVB-USB3300	ACTIVE LEVEL	DESCRIPTION
clock	Output	n/a	60MHz clock output from PHY.
data[7-0]	I/O	n/a	ULPI Bi-Directional data bus. Bit[7] is the MSB.
dir	Output	High	ULPI dir signal.
stp	Input	n/a	ULPI stp signal.
nxt	Output	n/a	ULPI nxt signal.
reset	Input	High	Reset Pin.
dc_psnt_n	Output	Low	When low, the Link detects the presence of a daughter-card. The EVB-USB3300 has a 200 ohm pull-down resistor.
psu_shd_n	Input	Low	When low, the PHY will source 3.3 volts from the daughter-card. The EVB-USB3300 has a 200 ohm pull-down resistor.
sys_clk	Input	n/a	Not used.
Reserved	I/O	n/a	Reserved.
GPIO0-14	I/O	n/a	General Purpose I/O. Not used.
GND	I/O	n/a	Ground Plane.
VBUS_in	I/O	n/a	Not used.
VBUS_out	I/O	n/a	5 Volt supply from the Link. Can be used by the EVB-USB3300 for driving V _{BUS} . To use remove power from jumper 4 and install jumper 5.
VDD	I/O	n/a	3.3 volt PHY Power supply.
VIO	I/O	n/a	3.3 volt I/O supply.
SPKR_L	Not used.	n/a	Reserved for carkit. Not used.
SPKR_MIC	Not used.	n/a	Reserved for carkit. Not used.

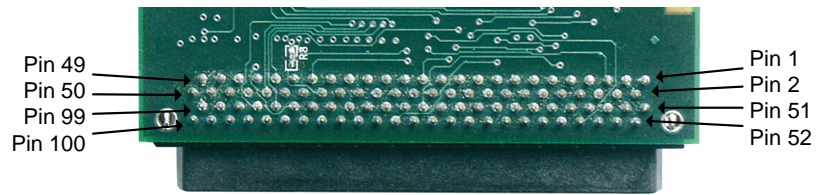
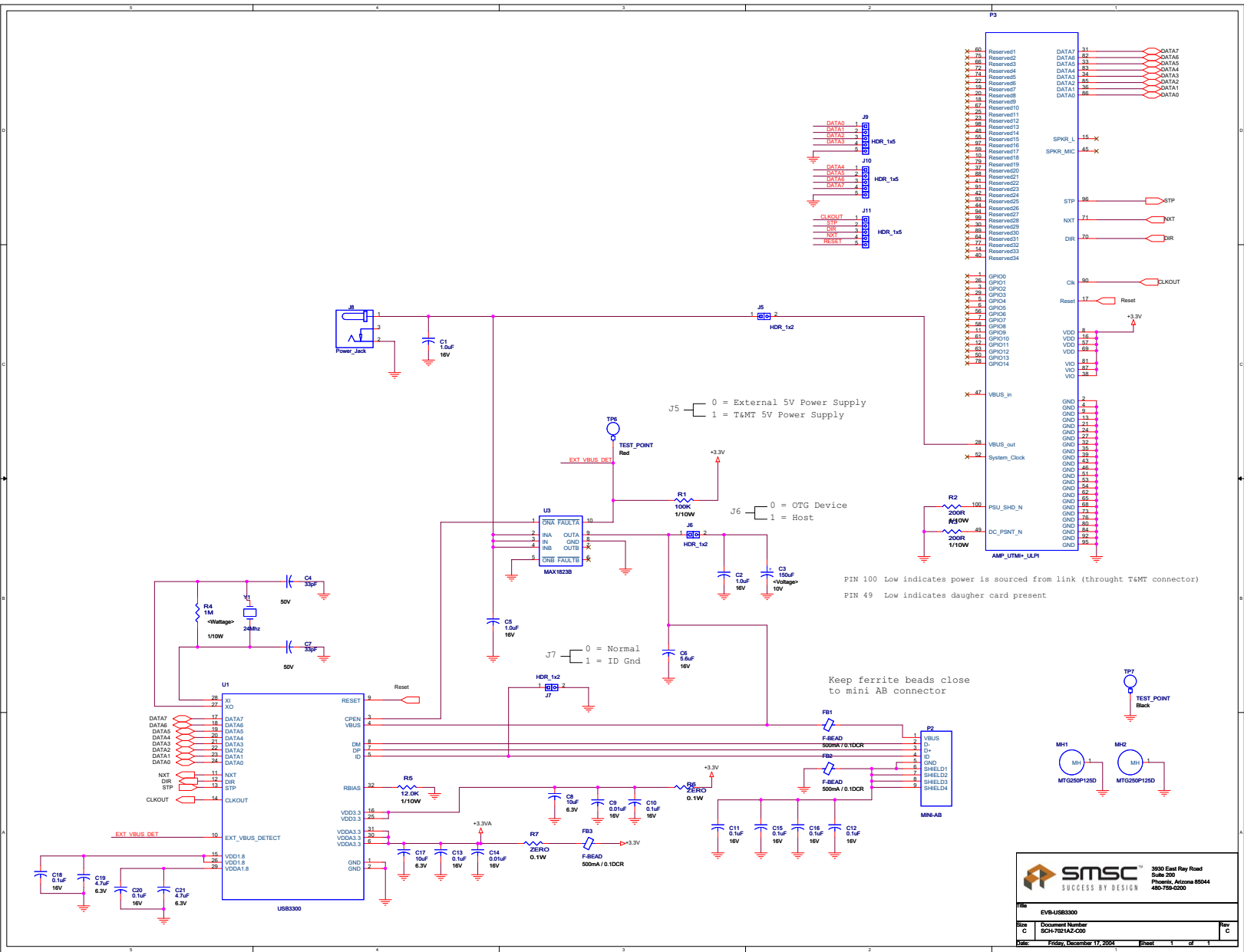

Figure 5 Back Side of board showing T&MT Connector pin numbers.

2.11 Boards Schematic

The schematic diagram is included for reference, and can be enlarged for increased readability. The schematic is also available from the SMSC web site as a separate pdf document.



SMSC
SUCCESS BY DESIGN

3950 East Ray Road
Suite 200
Phoenix, Arizona 85044
480-759-0200

EV4-USB3300

Document Number: SCH-7821AZ-C00

Friday, December 17, 2004 Sheet 1 of 1