

# NTMS4101P

## Trench Power MOSFET 20 V, 9.0 A, Single P-Channel, SO-8

### Features

- Leading -20 V Trench for Low  $R_{DS(on)}$
- Surface Mount SO-8 Package Saves Board Space
- Lead-Free Package for Green Manufacturing (G Suffix)

### Applications

- Power Management
- Load Switch
- Battery Protection

### MAXIMUM RATINGS ( $T_J = 25^\circ\text{C}$ unless otherwise noted)

Rating	Symbol	Value	Unit
Drain-to-Source Voltage	$V_{DS}$	-20	V
Gate-to-Source Voltage	$V_{GS}$	$\pm 8.0$	V
Continuous Drain Current	$I_D$	Steady State	-6.9
		$t \leq 10$ s	-9.0
Pulsed Drain Current	$I_{DM}$	-30	A
Power Dissipation	$P_D$	1.38	W
Operating Junction and Storage Temperature Range	$T_J, T_{stg}$	-55 to 150	$^\circ\text{C}$
Continuous Source Current (Body Diode)	$I_S$	-6.9	A
Lead Temperature for Soldering Purposes (1/8" from case for 10 seconds)	$T_L$	260	$^\circ\text{C}$

### THERMAL RESISTANCE RATINGS

Junction-to-Ambient - Steady State (Note 1)	$R_{\theta JA}$	90	$^\circ\text{C/W}$
Junction-to-Ambient - $t \leq 10$ s (Note 1)	$R_{\theta JA}$	50	

1. Surface-mounted on FR4 board using 1" sq. pad size (Cu. area = 1.127 in. sq. [1 oz.] including traces).



ON Semiconductor®

<http://onsemi.com>

$V_{(BR)DSS}$	$R_{DS(on)}$ TYP	$I_D$ MAX
-20 V	16 m $\Omega$ @ -4.5 V	-9.0 A
	22 m $\Omega$ @ -2.5 V	

P-Channel MOSFET

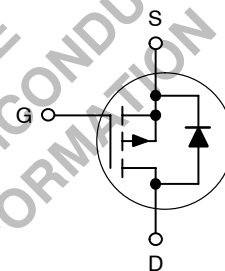

### MARKING DIAGRAM & PIN ASSIGNMENT

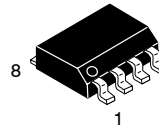

SO-8  
CASE 751  
STYLE 12

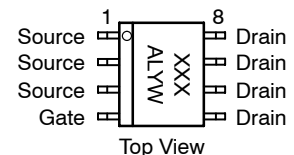

XXX = Specific Device Code  
A = Assembly Location  
L = Wafer Lot  
Y = Year  
W = Work Week

### ORDERING INFORMATION

Device	Package	Shipping
NTMS4101PR2	SO-8	2500/Reel
NTMS4101PR2G	SO-8 (Pb-Free)	2500/Reel

# NTMS4101P

## ELECTRICAL CHARACTERISTICS (T<sub>J</sub> = 25°C unless otherwise noted)

Parameter	Test Conditions	Symbol	Min	Typ	Max	Unit
-----------	-----------------	--------	-----	-----	-----	------

### OFF CHARACTERISTICS

Drain-to-Source Breakdown Voltage	V <sub>GS</sub> = 0 V, I <sub>D</sub> = -250 μA	V <sub>(BR)DSS</sub>	-20			V
Zero Gate Voltage Drain Current	V <sub>GS</sub> = 0 V, V <sub>DS</sub> = -16 V	I <sub>DSS</sub>			-10	μA
Gate-to-Source Leakage Current	V <sub>GS</sub> = ±8.0 V, V <sub>DS</sub> = 0 V	I <sub>GSS</sub>			±100	nA

### ON CHARACTERISTICS (Note 2)

Gate Threshold Voltage	V <sub>GS</sub> = V <sub>DS</sub> , I <sub>D</sub> = -250 μA	V <sub>GS(th)</sub>	-0.45			V
Drain-to-Source On-Resistance	V <sub>GS</sub> = -4.5 V, I <sub>D</sub> = -6.9 A	R <sub>DS(on)</sub>		16	19	mΩ
	V <sub>GS</sub> = -2.5 V, I <sub>D</sub> = -6.5 A			22	30	
Forward Transconductance	V <sub>DS</sub> = -15 V, I <sub>D</sub> = -6.9 A	g <sub>FS</sub>		70		S

### CHARGES AND CAPACITANCES

Input Capacitance	V <sub>GS</sub> = 0 V, f = 1 MHz, V <sub>DS</sub> = -10 V	C <sub>iss</sub>		3200		pF
Output Capacitance		C <sub>oss</sub>		320		
Reverse Transfer Capacitance		C <sub>rss</sub>		192		
Total Gate Charge	V <sub>GS</sub> = -4.5 V, V <sub>DS</sub> = -10 V, I <sub>D</sub> = -6.9 A	Q <sub>G(TOT)</sub>		29.5	32	nC
Gate-to-Source Charge		Q <sub>GS</sub>		6.0		
Gate-to-Drain Charge		Q <sub>GD</sub>		7.5		

### SWITCHING CHARACTERISTICS (Note 3)

Turn-On Delay Time	V <sub>GS</sub> = -4.5 V, V <sub>DD</sub> = -10 V, I <sub>D</sub> = -1.0 A, R <sub>G</sub> = 6.0 Ω	t <sub>d(on)</sub>		12.5		ns
Rise Time		t <sub>r</sub>		9.0		
Turn-Off Delay Time		t <sub>d(off)</sub>		144		
Fall Time		t <sub>f</sub>		38.5		

### DRAIN-SOURCE DIODE CHARACTERISTICS

Forward Diode Voltage	V <sub>GS</sub> = 0 V, I <sub>S</sub> = -6.9 A	V <sub>SD</sub>		0.72	0.95	V
Reverse Recovery Time	V <sub>GS</sub> = 0 V, V <sub>DS</sub> = -10 V, di/dt = 100 A/μs, I <sub>S</sub> = -6.9 A	t <sub>rr</sub>		28	35	ns
Charge Time		t <sub>a</sub>		12		
Discharge Time		t <sub>b</sub>		15		
Reverse Recovery Charge		Q <sub>rr</sub>		.017		nC

- Pulse Test: Pulse Width ≤ 300 μs, Duty Cycle ≤ 2%.
- Switching characteristics are independent of operating junction temperature.

# NTMS4101P

## TYPICAL PERFORMANCE CURVES ( $T_J = 25^\circ\text{C}$ unless otherwise noted)

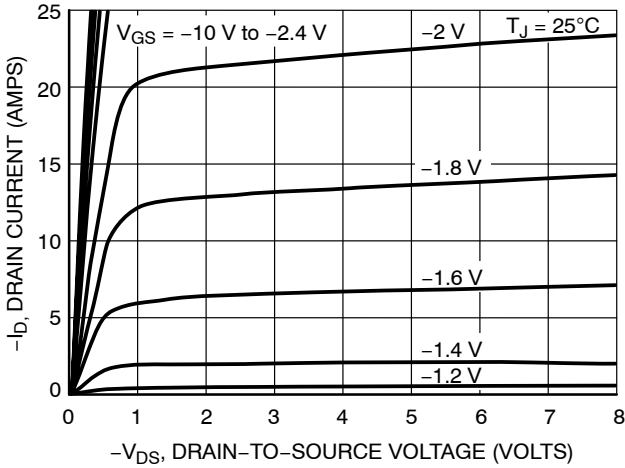

Figure 1. On-Region Characteristics

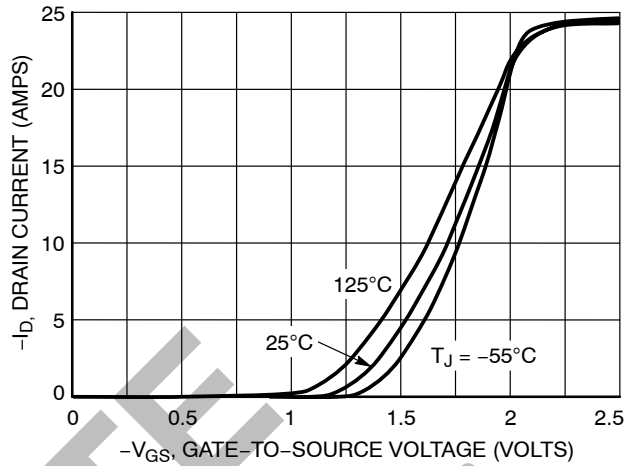

Figure 2. Transfer Characteristics

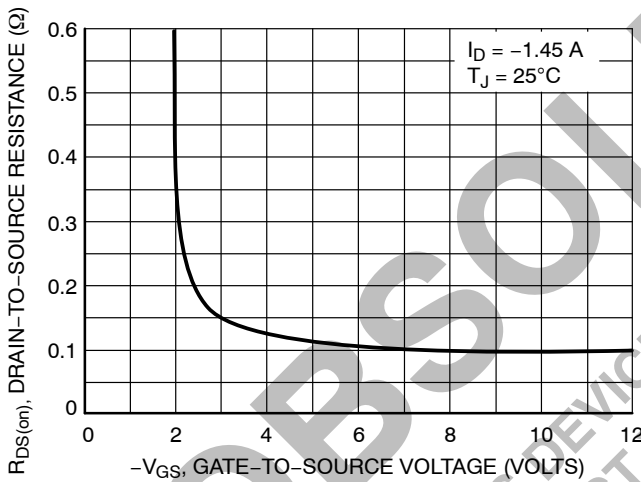

Figure 3. On-Resistance vs. Gate-to-Source Voltage

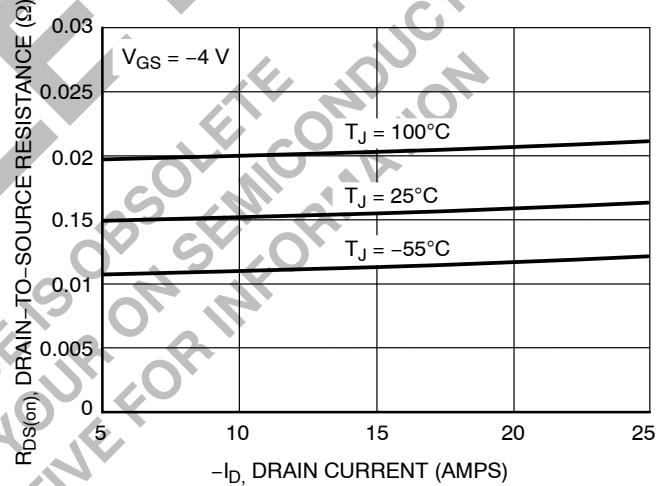

Figure 4. On-Resistance vs. Drain Current and Temperature

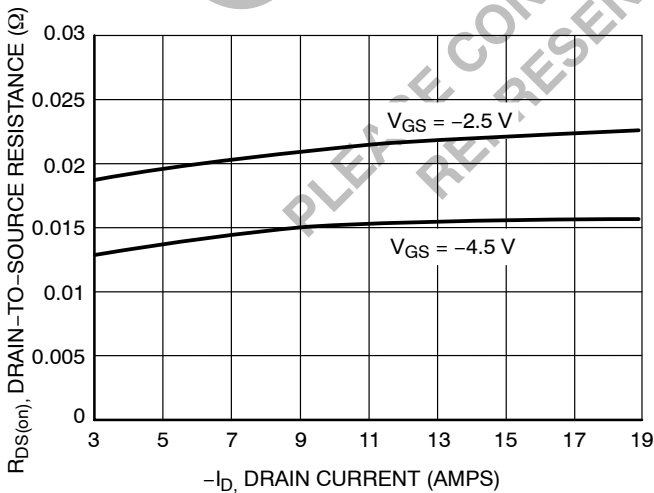

Figure 5. On-Resistance vs. Drain Current and Gate Voltage

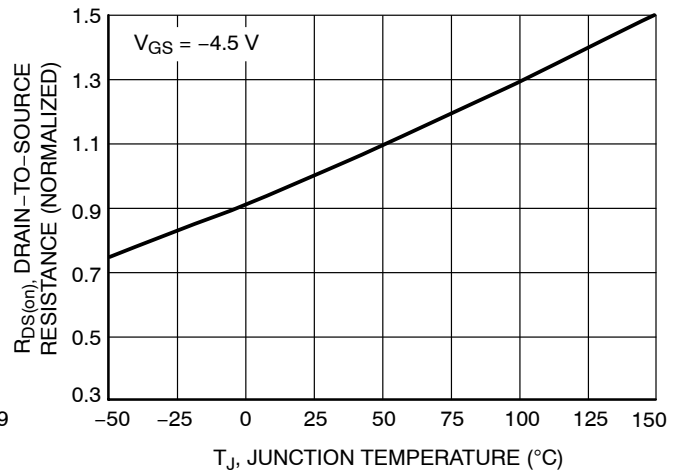

Figure 6. On-Resistance Variation with Temperature

# NTMS4101P

## TYPICAL PERFORMANCE CURVES ( $T_J = 25^\circ\text{C}$ unless otherwise noted)

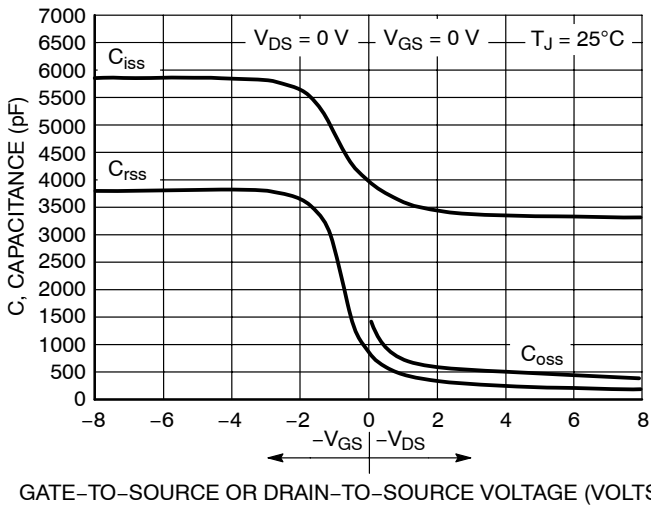

Figure 7. Capacitance Variation

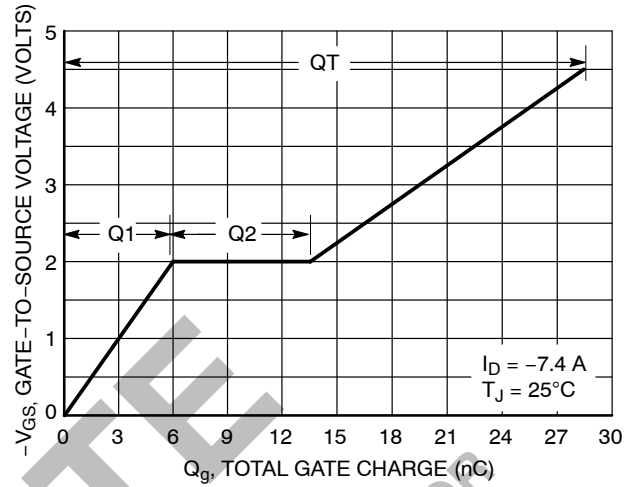

Figure 8. Gate-to-Source Voltage vs. Total Gate Charge

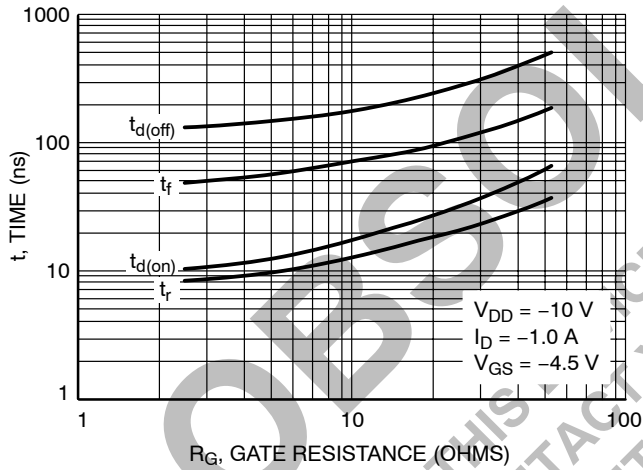

Figure 9. Resistive Switching Time Variation vs. Gate Resistance

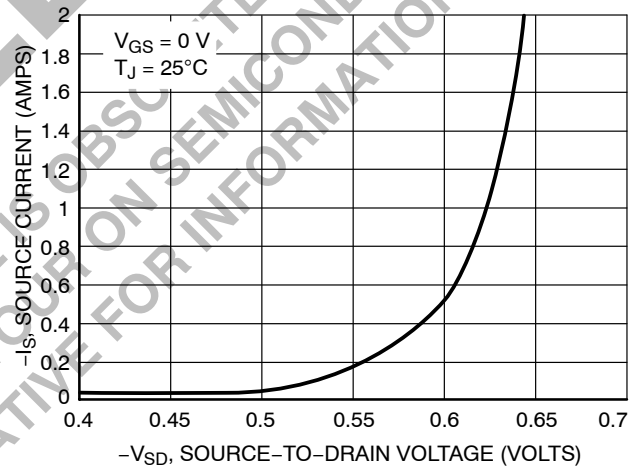

Figure 10. Diode Forward Voltage vs. Current

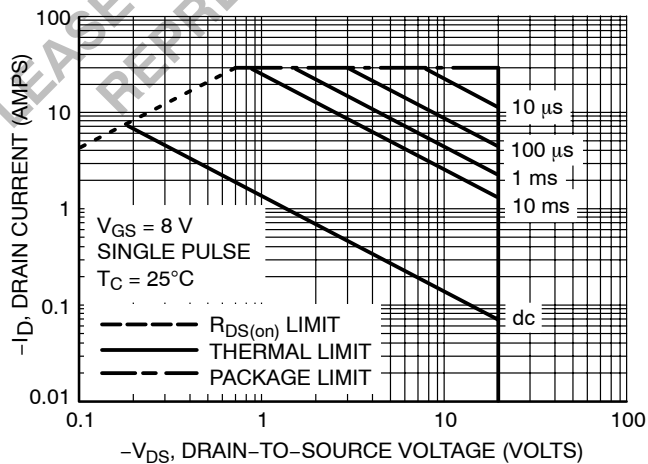
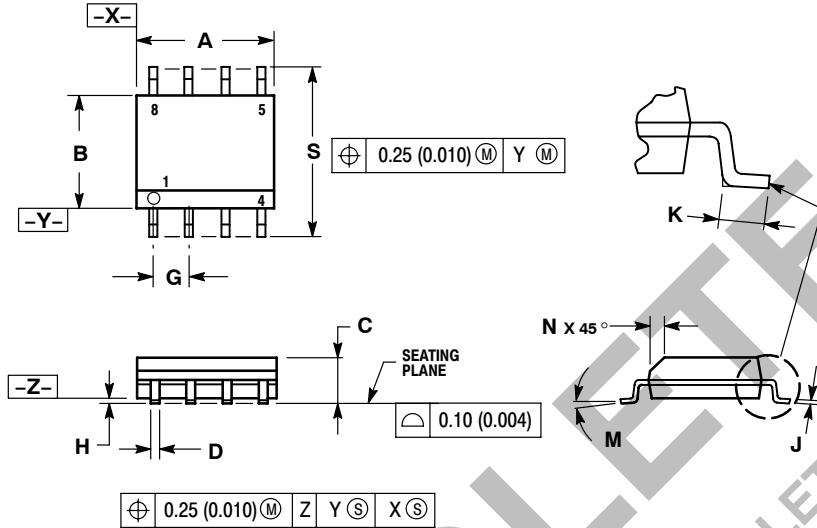

Figure 11. Maximum Rated Forward Biased Safe Operating Area

# NTMS4101P

## PACKAGE DIMENSIONS

SOIC-8 NB  
CASE 751-07  
ISSUE AA



### NOTES:

1. DIMENSIONING AND TOLERANCING PER ANSI Y14.5M, 1982.
2. CONTROLLING DIMENSION: MILLIMETER.
3. DIMENSION A AND B DO NOT INCLUDE MOLD PROTRUSION.
4. MAXIMUM MOLD PROTRUSION 0.15 (0.006) PER SIDE.
5. DIMENSION D DOES NOT INCLUDE DAMBAR PROTRUSION. ALLOWABLE DAMBAR PROTRUSION SHALL BE 0.127 (0.005) TOTAL IN EXCESS OF THE D DIMENSION AT MAXIMUM MATERIAL CONDITION.
6. 751-01 THRU 751-06 ARE OBSOLETE. NEW STANDARD IS 751-07.

DIM	MILLIMETERS		INCHES	
	MIN	MAX	MIN	MAX
A	4.80	5.00	0.189	0.197
B	3.80	4.00	0.150	0.157
C	1.35	1.75	0.053	0.069
D	0.33	0.51	0.013	0.020
G	1.27 BSC		0.050 BSC	
H	0.10	0.25	0.004	0.010
J	0.19	0.25	0.007	0.010
K	0.40	1.27	0.016	0.050
M	0°	8°	0°	8°
N	0.25	0.50	0.010	0.020
S	5.80	6.20	0.228	0.244

### STYLE 12:

1. SOURCE
2. SOURCE
3. SOURCE
4. GATE
5. DRAIN
6. DRAIN
7. DRAIN
8. DRAIN

ON Semiconductor and are registered trademarks of Semiconductor Components Industries, LLC (SCILLC). SCILLC reserves the right to make changes without further notice to any products herein. SCILLC makes no warranty, representation or guarantee regarding the suitability of its products for any particular purpose, nor does SCILLC assume any liability arising out of the application or use of any product or circuit, and specifically disclaims any and all liability, including without limitation special, consequential or incidental damages. "Typical" parameters which may be provided in SCILLC data sheets and/or specifications can and do vary in different applications and actual performance may vary over time. All operating parameters, including "Typicals" must be validated for each customer application by customer's technical experts. SCILLC does not convey any license under its patent rights nor the rights of others. SCILLC products are not designed, intended, or authorized for use as components in systems intended for surgical implant into the body, or other applications intended to support or sustain life, or for any other application in which the failure of the SCILLC product could create a situation where personal injury or death may occur. Should Buyer purchase or use SCILLC products for any such unintended or unauthorized application, Buyer shall indemnify and hold SCILLC and its officers, employees, subsidiaries, affiliates, and distributors harmless against all claims, costs, damages, and expenses, and reasonable attorney fees arising out of, directly or indirectly, any claim of personal injury or death associated with such unintended or unauthorized use, even if such claim alleges that SCILLC was negligent regarding the design or manufacture of the part. SCILLC is an Equal Opportunity/Affirmative Action Employer. This literature is subject to all applicable copyright laws and is not for resale in any manner.

### PUBLICATION ORDERING INFORMATION

#### LITERATURE FULFILLMENT:

Literature Distribution Center for ON Semiconductor  
P.O. Box 5163, Denver, Colorado 80217 USA  
Phone: 303-675-2175 or 800-344-3860 Toll Free USA/Canada  
Fax: 303-675-2176 or 800-344-3867 Toll Free USA/Canada  
Email: orderlit@onsemi.com

N. American Technical Support: 800-282-9855 Toll Free  
USA/Canada  
Europe, Middle East and Africa Technical Support:  
Phone: 421 33 790 2910  
Japan Customer Focus Center  
Phone: 81-3-5773-3850

ON Semiconductor Website: [www.onsemi.com](http://www.onsemi.com)

Order Literature: <http://www.onsemi.com/orderlit>

For additional information, please contact your local Sales Representative