

---

**IRU3055 EVALUATION BOARD USER GUIDE****INTRODUCTION**

The IRU3055 is a 3-phase synchronous Buck controller which provides high performance DC to DC converter for high current and low voltage applications, such as power supply for Intel or AMD processors. It can meet Intel VRM 9.0 specifications. The IRU3055 features on-Board DAC that programs the output voltage from 1.075V to 1.850V, loss-less short circuit protection, programmable switching frequency, soft-start, 3-phase on-board MOSFET drivers and PGood function, etc. The evaluation board is designed to provide 60A load at 1.5V output. The output voltage droop function is also included to meet the Intel specification.

(see the IRU3055 data sheet for detailed description).

**SPECIFICATION DATA**

$V_{IN}=12V$

$V_{OUT}=1.5V @ (D4=0 \text{ and } D0=0)$

$I_{OUT}=60A$

switching frequency  $F_s=150KHz$

---

**INPUT/OUTPUT CONNECTIONS**

The following is the input/output connections:

**Inputs:**

JP1: Power input, +12V,+5V and GND

JP2: Power input, +IN and RETURN

JP3: 20-pin ATX connector

JP4: Jumper. The power input of converter. It can be configured at +5V or +12V. Default is +12V input.

JP7: DAC input setting. '0' is set by using a 2-pin short connector. Default setting is '1' for each input. Default setting is 1.075V. To provide a 1.5V output, the pin "D4" and "D0" should be set to '1' by using 2-pin short connector.

**Outputs:**

JP5: + $V_{OUT}$  output

JP6: +GND output

JP8: PGood output

JP9: 3.3V input and 1.2V VID and VIDGood output

JP10: Tektronics probe test point

**INSTRUCTIONS****Short Circuit Test**

The IRU3055 provides hiccup mode current limit. It senses the  $R_{DS(ON)}$  of low side MOSFET in channel 1 and provides lossless over current protection. It can be tested by shorting the output terminal to ground through a short piece of wire.

 **$V_{DROOP}$  Function**

In this demo-board, the voltage droop function is provided by default. The output voltage decreases as load current increases. The output voltage versus load line falls into the specification by INTEL.

The voltage droop function can be disabled by setting resistor R33 to zero or to short. In that case, the IRU3055 regulates the output voltage to the set voltage by the DAC setting. The output voltage does not linearly decrease as load current increases.

**SCHEMATIC**

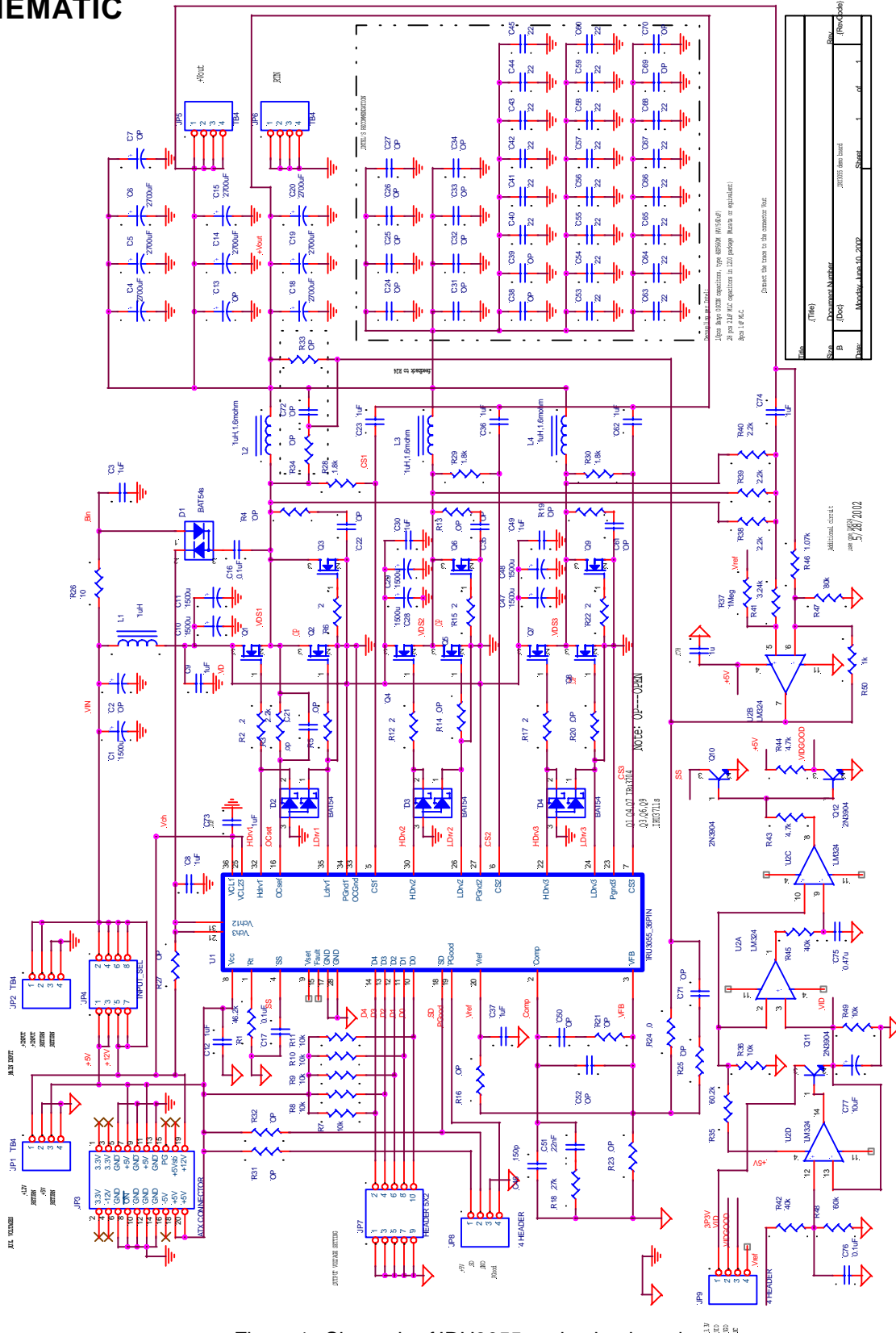

Titre	(Title)	
Stat.	Document Number	Doc
B	(Doc)	200505 Rev.001
Date	Model: IRLM10_2002	Sheet 1 of 1

Figure 1 - Schematic of IRU3055 evaluation-board.

**PARTS LIST**

Ref Desig	Description	Value	Qty	Part#	Manuf	Web site (www.)
Q1,Q4,Q7	MOSFET	20V, 9mΩ	3	IRF3704S	IR	irf.com
Q3,Q6,Q9	MOSFET	20V, 6mΩ	3	IRF3711S	IR	
Q10,11,12	Transistor	2N3904	3			
U1	Controller	Synchronous PWM	1	IRU3055	IR	
U2	OPAMP		1	LM324,14-pin SOIC	3M	
D1	Schottky Diode		1	BAT54S	IR	
D2,D3,D4	Schottky Diode		3	BAT54A	IR	
L1	Inductor	1.3μH, 10A	1	Z9479-A	Coilcraft	coilcraft.com
L2,L3,L4	Inductor	1μH, 20A	3	T60-18 core, 6 turns #14 AWG		
C1,10,11,28,29,47,48	Cap,Electrolytic	1500μF, 16V	7	EEU-FJ1C152	Panasonic	maco.panasonic.co.jp
C3,8,9,30,49	Cap, Ceramic	1μF, X7R, 25V	5	ECJ-3YB1E105K	Panasonic	
C4,5,6,14,15,18,19,20	Cap,Electrolytic	2700μF, 6.3V, 13mΩ	8	EEU-FJ0J222	Panasonic	
C12,23,36,37,62,73,74,78	Cap, Ceramic	1μF, Y5V, 16V	8	ECJ-2VF1C105Z	Panasonic	
C16,17,76	Cap, Ceramic	0.1μF, Y5V, 25V	3	ECJ-2VF1E104Z	Panasonic	
C46	Cap, Ceramic	150pF, 50V, Y5	1	ECU-V1H151JCG	Panasonic	
C51	Cap, Ceramic	22nF, Y5V, 25V	1	ECJ-2VF1E223K	Panasonic	
C75	Cap, Ceramic	0.47μF, X&R, 16V	1	ECJ-2YB1C474K	Panasonic	
C77	Capacitor	15μF, Tantalum	1	ECS-TOJX156R	Panasonic	
R1	Resistor	46.4K, 1%	1			
R2,6,12,15,17,22	Resistor	2.15Ω, 5%	6			
R3	Resistor	2.21K, 1%	1			
R7,8,9,10,11,36,49	Resistor	10K, 1%	7			
R18	Resistor	26.7K, 1%	1			
R24	Resistor	0Ω	1			
R26	Resistor	10Ω, 5%	1			
R28,29,30	Resistor	1.8K, 1%	3			
R35,R48	Resistor	60.4K, 1%	2			
R37	Resistor	1M, 1%	1			
R38,39,40	Resistor	2.21K, 1%	3			
R41	Resistor	3.24K	1			
R42,R45	Resistor	40.2K, 1%	2			
R43,R44	Resistor	4.64K, 5%	2			
R46	Resistor	1.07K	1			
R47	Resistor	80.6K, 1%	1			
R50	Resistor	1K	1			
JP1,2,5,6	Terminal		4	ED1973-ND	DigiKey	
JP3	Terminal		1	147379	Jameco	
JP7	Terminal		1	S201205-ND		
JP8,JP9	Terminal		2	S1012-04-ND	DigiKey	
JP10	Scope Probe Connector		1	131503100	Tektronix	

**CONNECTION DIAGRAM**

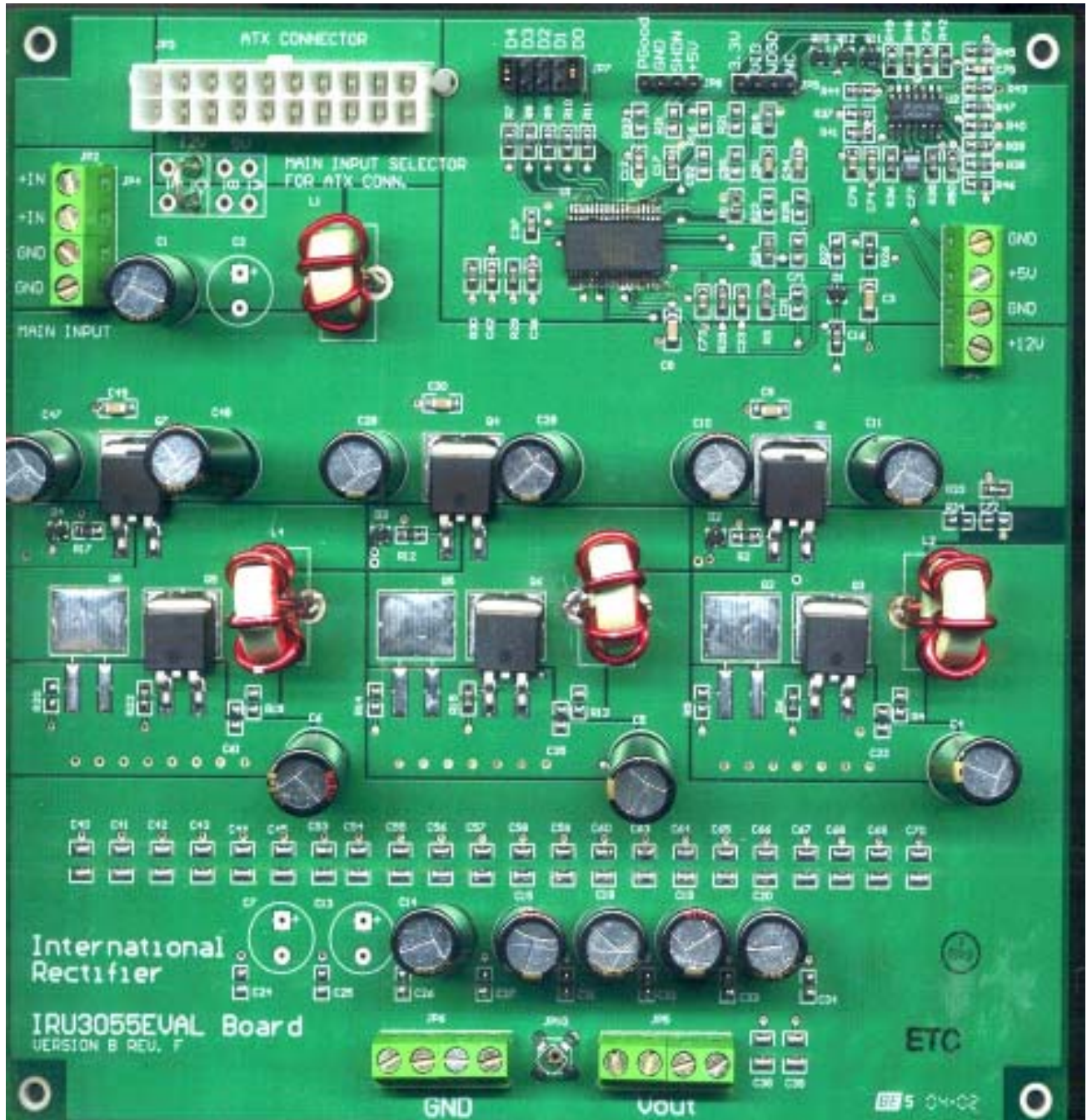

Figure 2 - Picture of IRU3055 evaluation-board.

**LAYOUT**

The top side (component) layer for IRU3055 Eval board is shown in Figure 3. The input capacitors are all located close to the MOSFETs. All the decoupling capacitors, charge pump capacitors and feedback components are located close to IC. The feedback pin  $V_{FB}$  is connected

to the output voltage at the output terminal.

The PCB is a 4-layer board. One layer is dedicated to Power GND. The analog GND is separated from the PGND and is connected at a single point.

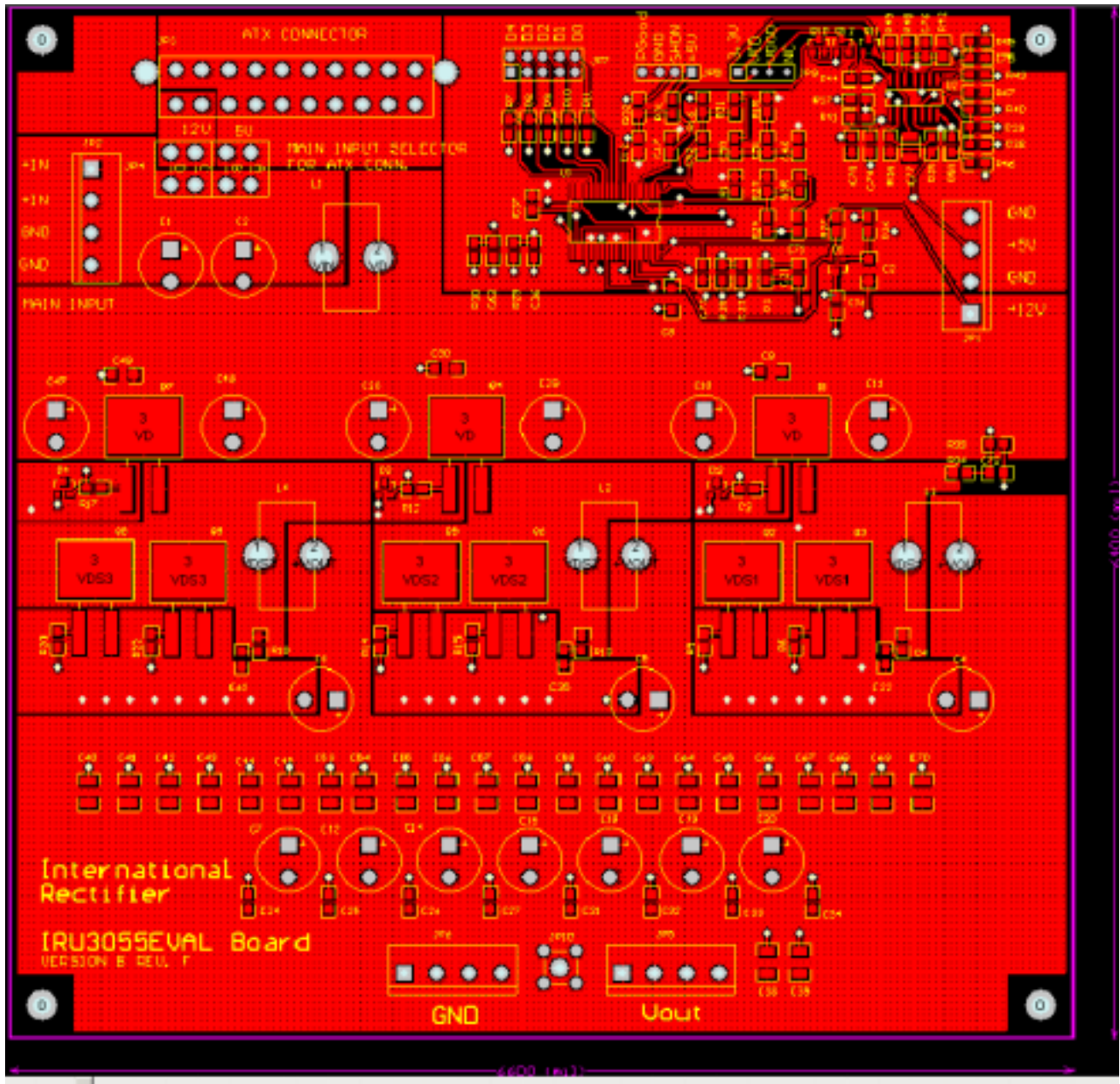

Figure 3 - Top layer of IRU3055 demo-board PCB layout.

**LAYOUT**

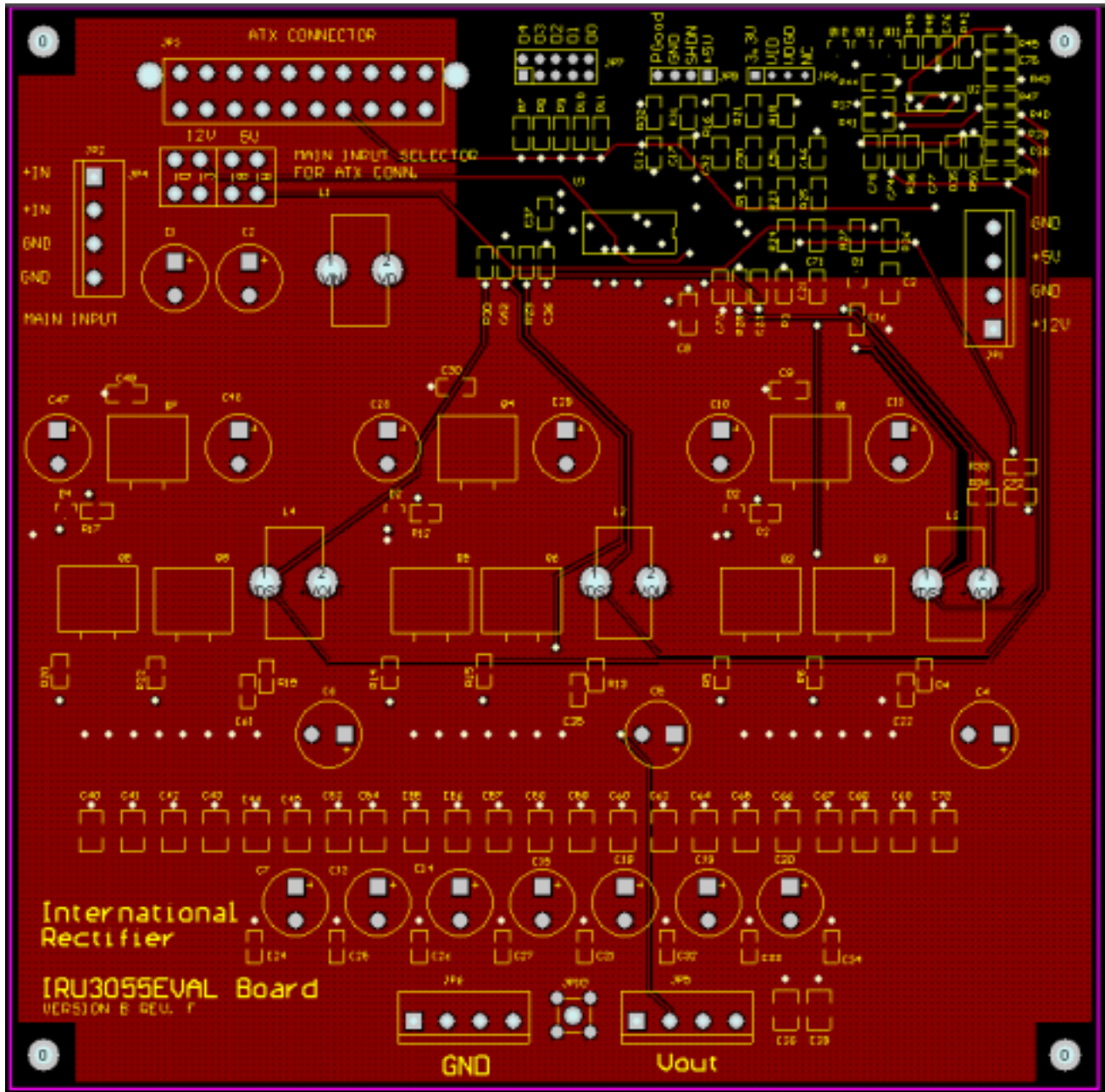

Figure 4 - Second layer of IRU3055 demo-board PCB layout.

LAYOUT

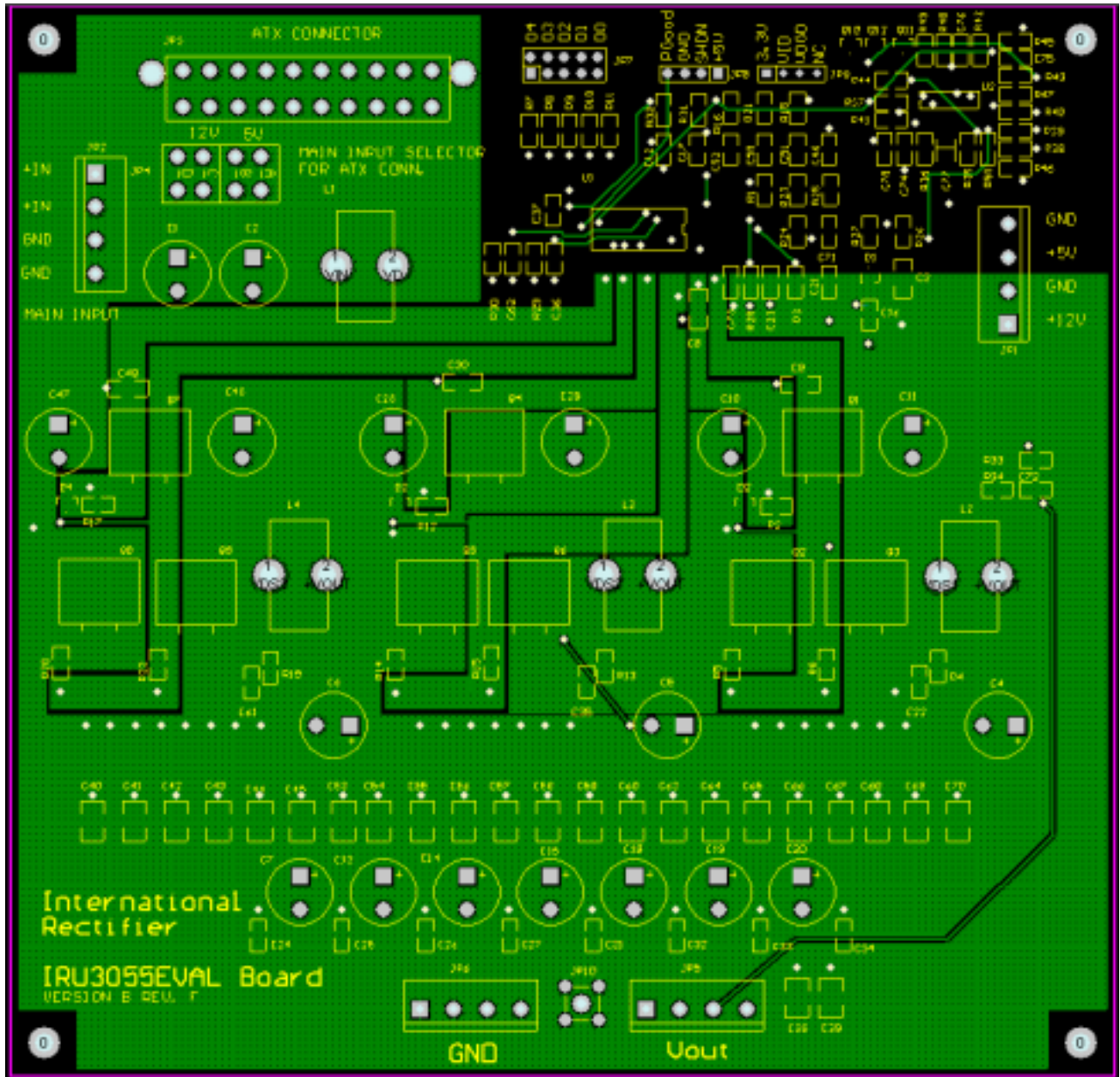

Figure 5 - Third layer of IRU3055 demo-board PCB layout.

**LAYOUT**

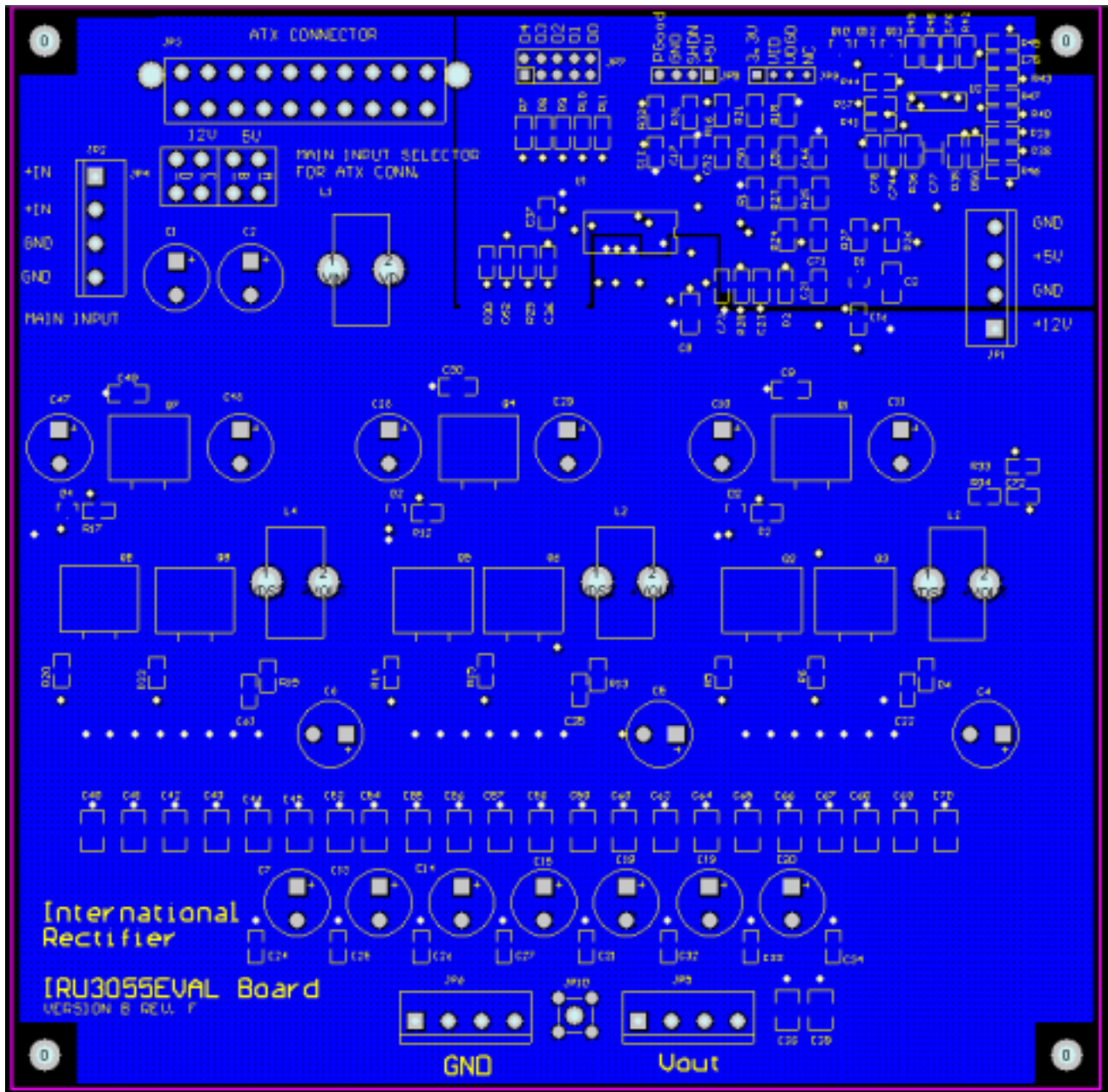

Figure 7 - The bottom layer of IRU3055 demo-board PCB layout.



**TEST WAVEFORMS WITHOUT ACTIVE VOLTAGE DROOP (R33=0)**

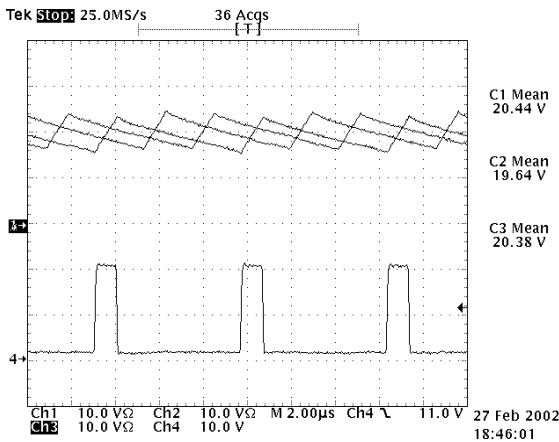

Figure 8 - 3-Phase inductor current at 60A load, Ch1, Ch2 and Ch3: 10A/div. Ch4: gate signal.

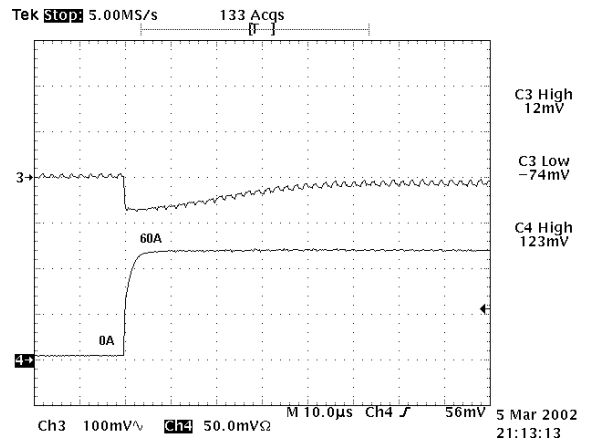

Figure 11 - Zoomed 60A Load dynamic (rising). Ch3: Output voltage, 100mV/div, AC. Ch4: Load current, 20A/us, sensed by 2mΩ resistor, 25A/div.

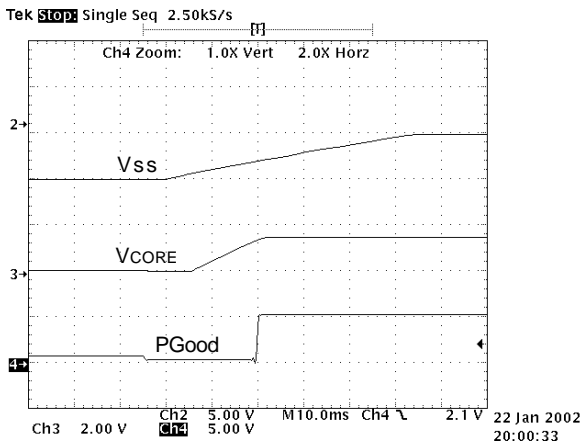

Figure 9 - Soft-start, Vcore and PGood.

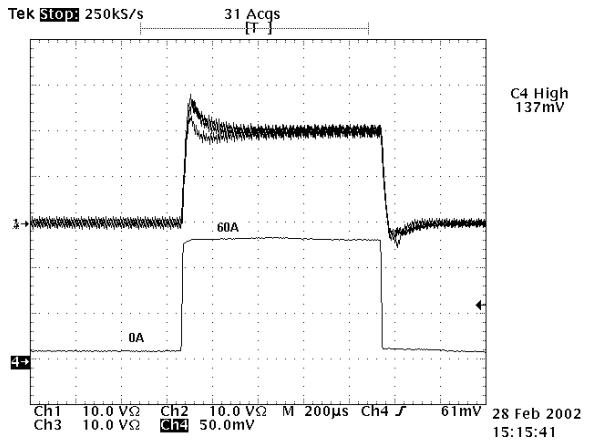

Figure 12 - 60A load dynamic waveforms with three-phase inductor current. Ch1, Ch2 and Ch3: Inductor current, 10A/div. Ch4: Load current, 20A/us, sensed by 2mΩ resistor, 25A/div.

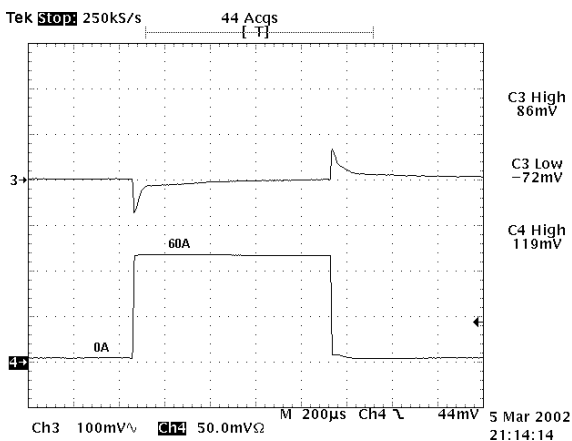

Figure 10 - 60A Dynamic load response with 20A/µs slew rate. Ch3: Output voltage, 100mV/div, AC. Ch4: Load current, 20A/us, sensed by 2mΩ resistor, 25A/div.

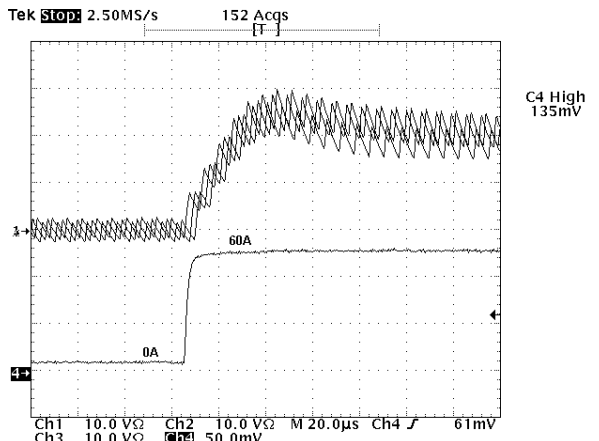

Figure 13 - 60A load dynamic waveforms with three-phase inductor current. (Zoomed) Ch1, Ch2 and Ch3: Inductor current, 10A/div. Ch4: Load current, 20A/us, sensed by 2mΩ resistor, 25A/div.

**TEST WAVEFORMS WITH ACTIVE VOLTAGE DROOP (R33=OPEN)**

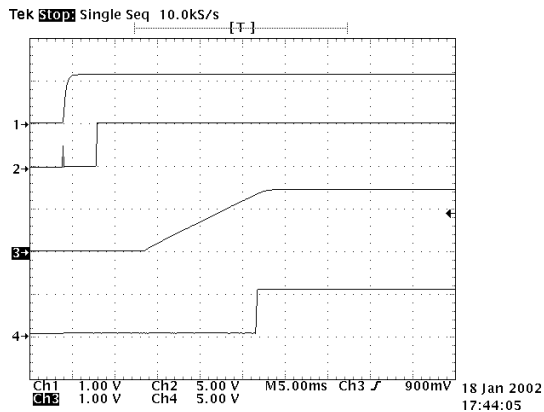

Figure 14 - Soft-start.  
 Ch1: 1.2V VID. Ch2: VID Good.  
 Ch3: 1.5V Output. Ch4: PGood.

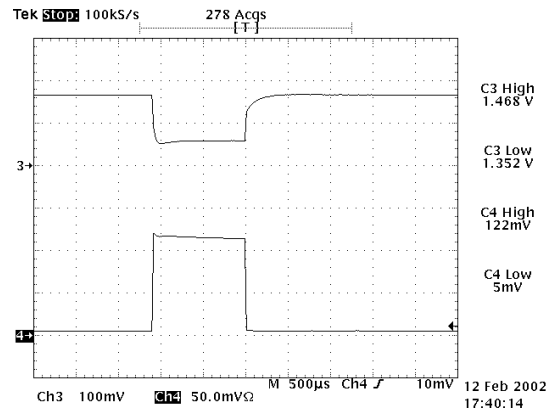

Figure 15 - 60A Load dynamic with 20A/ $\mu$ s slew rate.  
 Ch4: Output current, sensed through 2m $\Omega$  resistor, 25A/div.  
 Ch3: Output voltage, DC offset 1.3V, 100mV/div.

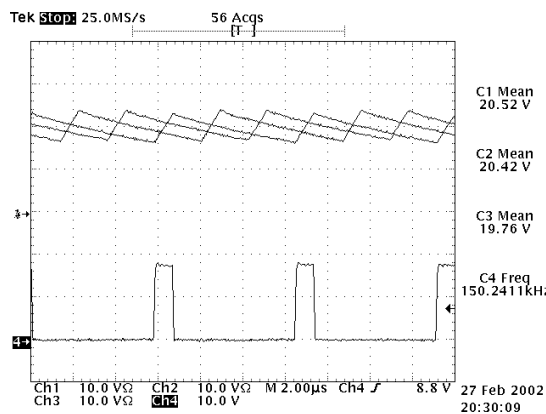

Figure 16 - 3-Phase inductor current at 60A load,  
 Ch1, Ch2 and Ch3: 10A/div and gate signal.