

QPA6489A

DC to 3500 MHz, CASCADABLE SiGe HBT MMIC AMPLIFIER

The QPA6489A is a high performance SiGe HBT MMIC amplifier. A Darlington configuration provides high F_T and excellent thermal performance. The heterojunction increases breakdown voltage and minimizes leakage current between junctions. Cancellation of emitter junction non-linearities results in higher suppression of intermodulation products. Only two DC-blocking capacitors, a bias resistor, and an optional RF choke are required for operation.



SOT-89 Package

Features

- DC to 3500MHz Operation
- High Gain: 19.2 dB at 1950MHz
- Cascadable 50 Ω
- Operates from Single Supply
- Low Thermal Resistance Package

Functional Block Diagram

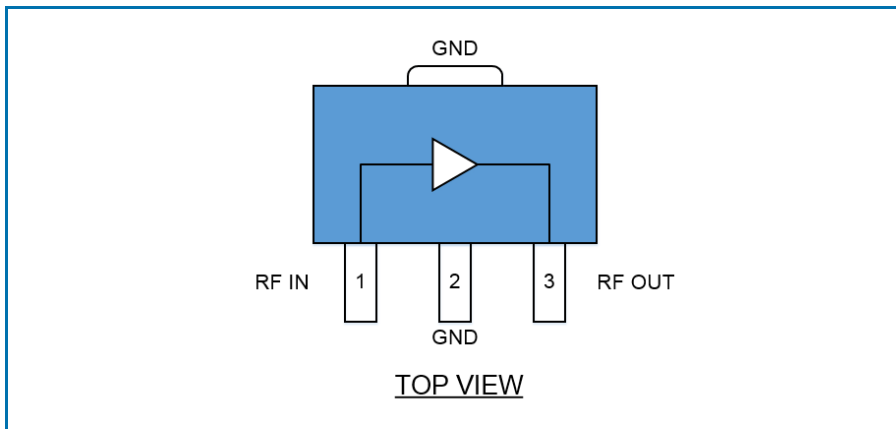

Applications

- Power Amplifier Driver
- Cellular, PCS, GSM, UMTS
- IF Amplifier
- Wireless Data, Satellite

Ordering Information

QPA6489ASQ	Sample Bag with 25 pieces
QPA6489ASR	7" Reel with 100 pieces
QPA6489ATR13	13" Reel with 3500 pieces
QPA6489APCK401	850MHz, 8V Operation PCBA with 5-piece Sample Bag

QPA6489A

Absolute Maximum Ratings

Parameter	Rating	Units
Device Voltage(V _D)	+7.0	V
Device Current (I _D)	150	mA
RF Input Power ^{Note 1}	+18	dBm
Storage Temperature	-55 to +150	°C
ESD Rating (HBM)	TBD	V
Moisture Sensitivity Level	MSL2	-



Caution! ESD sensitive device.



RFMD Green: RoHS status based on EU Directive 2011/65/EU (at time of this document revision), halogen free per IEC 61249-2-21, < 1000 ppm each of antimony trioxide in polymeric materials and red phosphorus as a flame retardant, and <2% antimony in solder.

Notes:

1. Load Condition 1: Z_L = 50 Ω
2. Operation of this device beyond any one of these limits may cause permanent damage. For reliable continuous operation, the device voltage and current must not exceed the maximum operating values specified in this table.
3. Bias Conditions should also satisfy the following expression: I_DV_D < (T_J - T_L) / R_{TH}, and T_L = T_{LEAD}.

Exceeding any one or a combination of the Absolute Maximum Rating conditions may cause permanent damage to the device. Extended application of Absolute Maximum Rating conditions to the device may reduce device reliability. Specified typical performance or functional - operation of the device under Absolute Maximum Rating conditions is not implied.

Recommended Operating Conditions

Parameter	Rating			Units
	Min	Typ	Max	
Operating Temperature Range	-40		+85	°C
Junction Temperature (T _J)			+125	°C
Device Operating Voltage	+4.7	+5.1	+5.5	V

Electrical Specifications – General

Parameter	Specification			Units	Conditions
	Min	Typ	Max		
Small Signal Gain, S ₂₁		20.3		dB	850MHz
		19.2		dB	1950MHz
		18.5		dB	2400MHz
Output Power at 1 dB Compression		+20.1		dBm	850MHz
		+19.4		dBm	1950MHz
		+18.4		dBm	2400MHz
Output Third Order Intercept Point		+36.0		dBm	500MHz
		+36.0		dBm	850MHz
		+31.9		dBm	1950MHz
Input Return Loss, S ₁₁		+30.4		dBm	2400MHz
		30.7		dB	850MHz
		19.4		dB	1950MHz
Output Return Loss, S ₂₂		14.7		dB	2400MHz
		20.9		dB	850MHz
		10.4		dB	1950MHz
		9.0		dB	2400MHz

Test Conditions unless otherwise specified: +V_D = +5.1 V, V_S = 8 V, I_D = 75 mA Typ., OIP3 Tone Spacing=1 MHz, P_{OUT} per tone = 0 dBm, R_{BIAS} = 39Ω, T_L = 25°C, Z_S = Z_L = 50 Ω

QPA6489A

Electrical Specifications – General (Continued)

Parameter	Specification			Units	Conditions
	Min	Typ	Max		
Reverse Isolation, S12		23.5		dB	850MHz
		24.3		dB	1950MHz
		24.8		dB	2400MHz
Noise Figure		3.2		dB	850MHz
		3.4		dB	1950MHz
		3.7		dB	2400MHz
Thermal Resistance		97		°C/W	
Device Operating Current		75		mA	

Test Conditions unless otherwise specified: $+V_D = +5.1\text{ V}$, $V_S = 8\text{ V}$, $I_D = 75\text{ mA Typ.}$, OIP3 Tone Spacing=1 MHz, P_{OUT} per tone = 0 dBm, $R_{BIAS} = 39\Omega$, $T_L = 25^\circ\text{C}$, $Z_S = Z_L = 50\Omega$

Typical Performance Using 850MHz Application Circuit

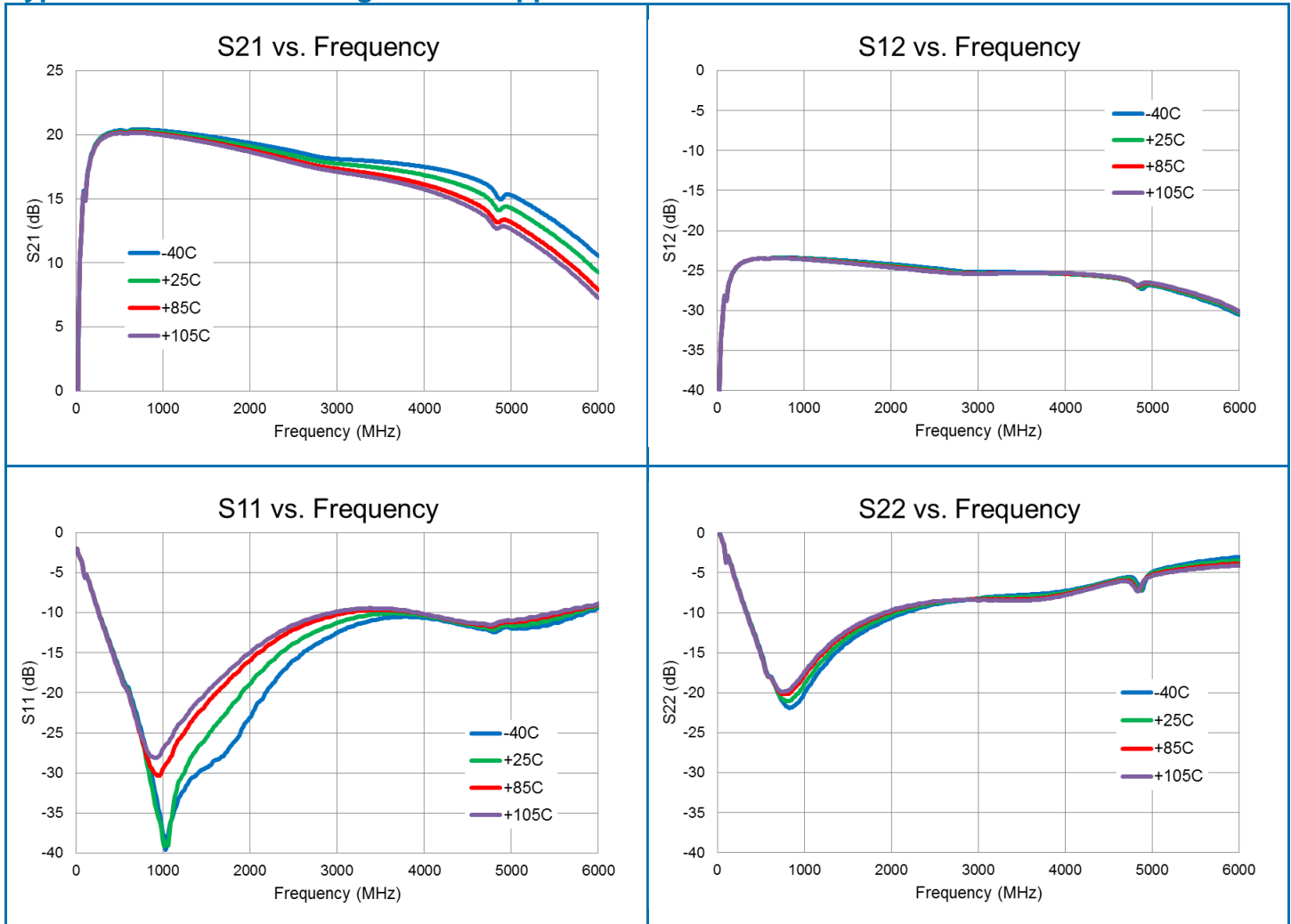

QPA6489A

Typical Performance Using 850MHz Application Circuit

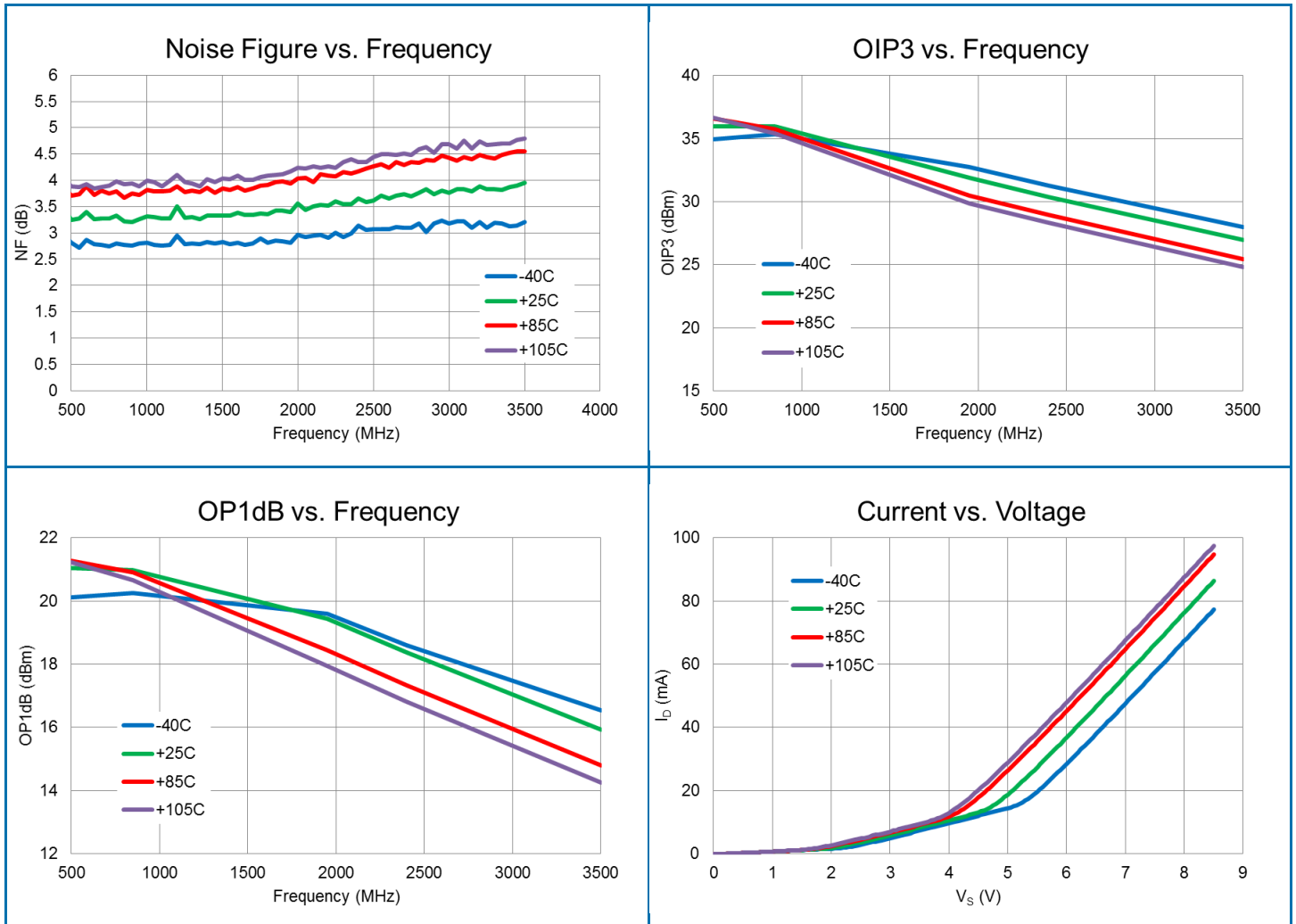

QPA6489A

Evaluation Board and Schematic

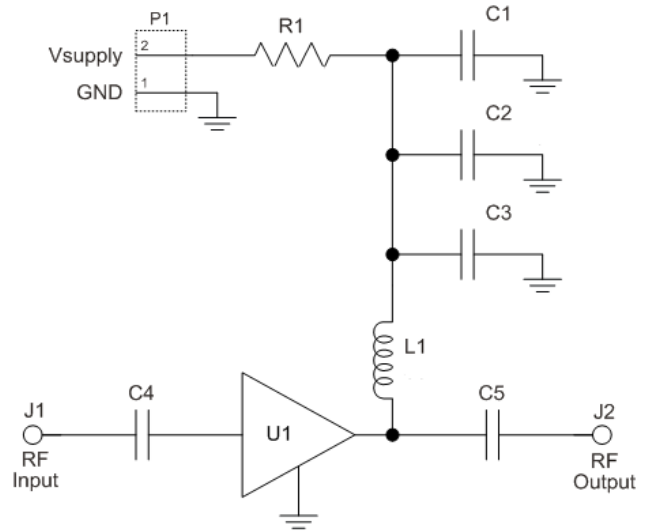
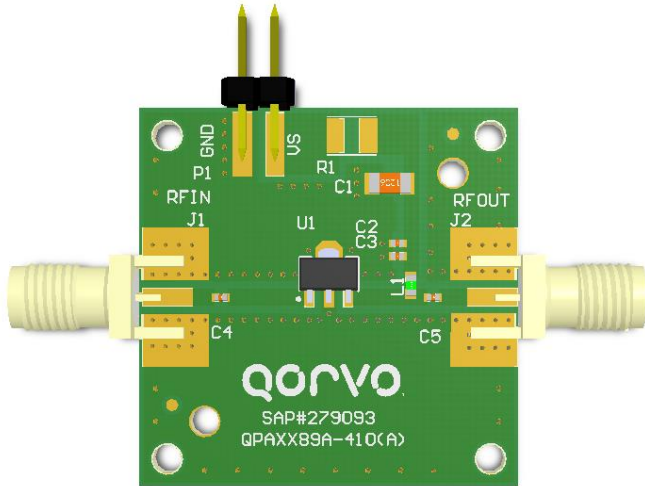

Evaluation Board Bill of Materials For 850MHz Application Circuit

Description	Reference Designator	Manufacturer	Manufacturer's P/N
Gain Block	U1	QORVO	QPA6489A
PCB	NA	Viasystems	QPAXX89A
CAP, 1uF, 10%, 25V, X7R, 1206	C1	Murata Electronics	GRM31MR71E105KA01L
CAP, 1000pF, 10%, 50V, X7R, 0402	C2	Murata Electronics	GRM155R71H102KA01D
CAP, 68pF, 5%, 50V, C0G, 0402	C3	Murata Electronics	GRM1555C1H680JA01D
CAP, 100pF, 5%, 50V, C0G, 0402	C4, C5	Murata Electronics	GRM1555C1H101JA01D
RES, 39 OHM, 1%, 1/2W, 1210	R1	Panasonic Industrial Devices	ERJ-P14F39R0U
IND, 33nH, 5%, M/L, 0603	L1	Murata Electronics	LL1608-FSL33NJ
CONN, SMA, EL, FLT, 0.068" SPE-000318	J1, J2	Amphenol RF Asia Corp	901-10426
CONN, HDR, ST, 1x2, 0.100", HI-TEMP, T/H	P1	Samtec Inc.	HTSW-102-07-G-S

QPA6489A

Component Values For Specific Frequency and Voltage in Application Circuit

Reference Designator	Frequency (MHz)				
	500	850	1950	2400	3500
C ₄ , C ₅	220pF	100pF	68pF	56pF	39pF
C ₃	100pF	68pF	22pF	22pF	15pF
L ₁	68nH	33nH	22nH	18nH	15nH
Required Bias Resistance for I _D =75mA Bias Resistance = R _{BIAS} + R _{LDC} = (V _S -V _D) / I _D					
Supply Voltage (V _s)	6 V	8 V	8 V	10 V	12 V
Bias Resistance (R ₁ = R _{Bias})	12 Ω	39 Ω	39 Ω	62 Ω	91 Ω

*Note: Bias resistor improves current stability over temperature

Pin Configuration and Description

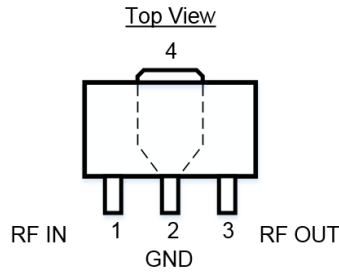

Pin	Label	Description
1	RF IN	RF input pin. This pin requires the use of an external DC blocking capacitor as shown in the application schematics
2	GND	Connect to ground per application circuit drawing.
3	RF OUT	RF output and bias pin. Bias will be supplied to this pin through an external RF choke. A DC blocking capacitor is necessary on the RF output as shown in the application circuit
4	GND	Exposed area on the bottom side of the package needs to be soldered to the ground plane of the board for thermal and RF performance. Vias should be located under the EPAD as shown in the recommended land pattern.

QPA6489A

Package Marking

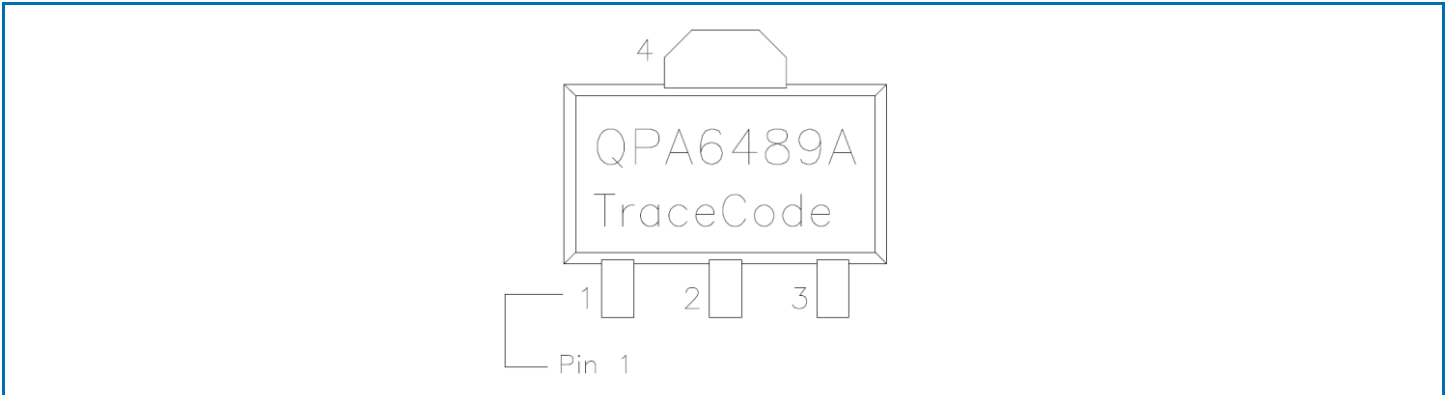

Suggested Pad Layout (Dimensions in millimeters)

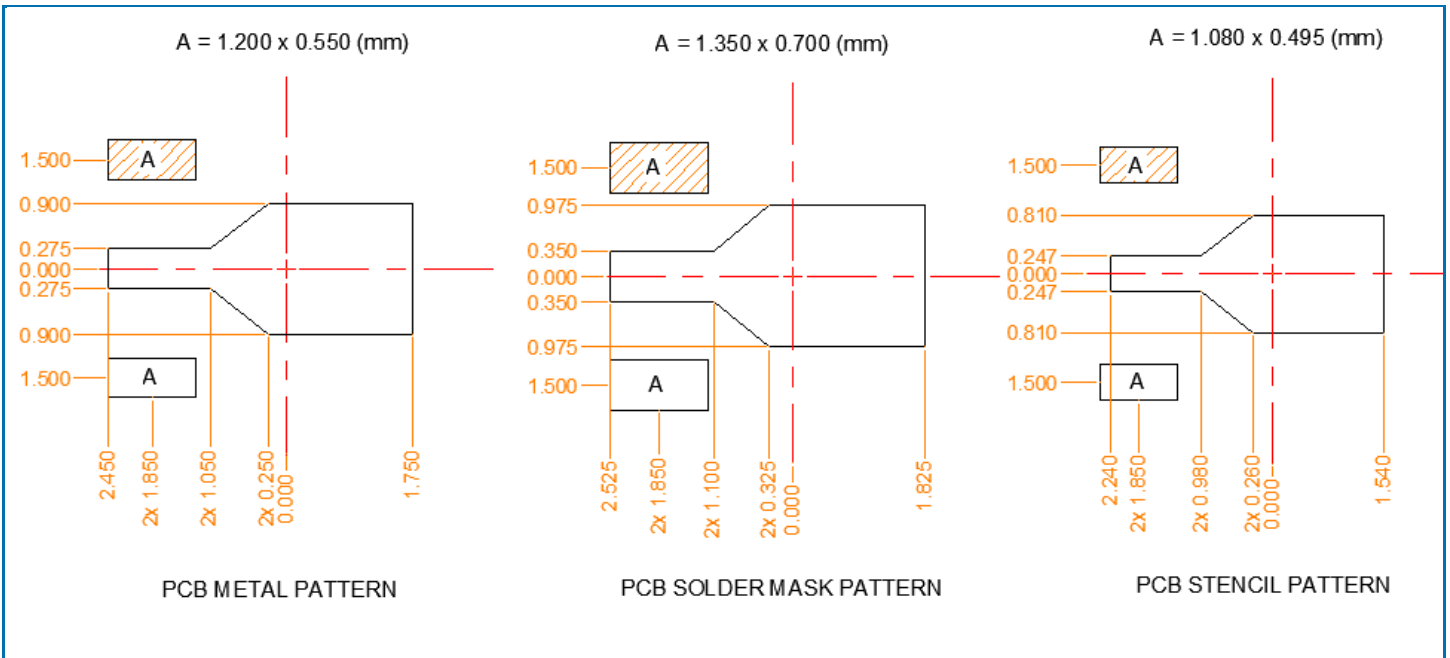

Preliminary

QPA6489A

Package Outline (Dimensions in millimeters)

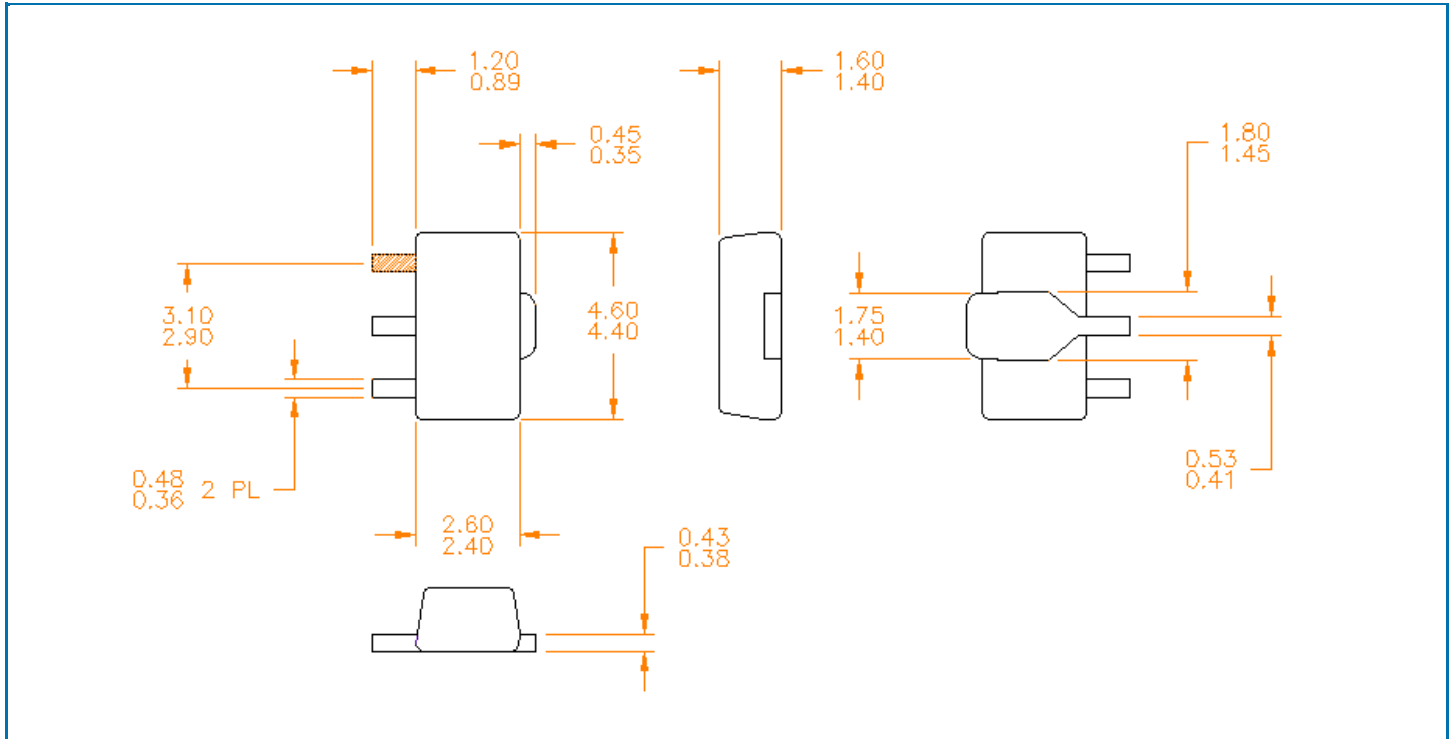

Preliminary



QPA6489A

Contact Information

For the latest specifications, additional product information, worldwide sales and distribution locations:

Web: www.rfmd.com **Tel:** 1-844-890-8163
Email: customer.support@qorvo.com

For information about the merger of RFMD and TriQuint as Qorvo:

Web: www.qorvo.com

Important Notice

The information contained herein is believed to be reliable. RFMD and or Qorvo makes no warranties regarding the information contained herein. RFMD and or Qorvo assumes no responsibility or liability whatsoever for any of the information contained herein. RFMD and or Qorvo assumes no responsibility or liability whatsoever for the use of the information contained herein. The information contained herein is provided "AS IS, WHERE IS" and with all faults, and the entire risk associated with such information is entirely with the user. All information contained herein is subject to change without notice. Customers should obtain and verify the latest relevant information before placing orders for RFMD and or Qorvo products. The information contained herein or any use of such information does not grant, explicitly or implicitly, to any party any patent rights, licenses, or any other intellectual property rights, whether with regard to such information itself or anything described by such information.

RFMD and or Qorvo products are not warranted or authorized for use as critical components in medical, life-saving, or life-sustaining applications, or other applications where a failure would reasonably be expected to cause severe personal injury or death.