

# Hyper Mini TOPLED® Hyper-Bright LED

LB M673, LV M673, LT M673

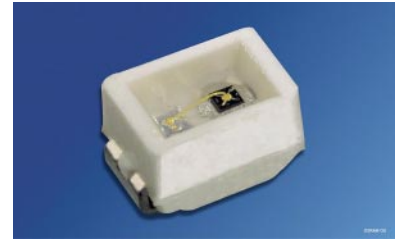

## Vorläufige Daten / Preliminary Data

### Besondere Merkmale

- **Gehäusetyp:** weißes SMT Gehäuse
- **Besonderheit des Bauteils:** kleine Bauform für Anwendungen mit wenig Platzbedarf
- **Wellenlänge:** 470 nm (blau), 505 nm (verde), 528 nm (true green)
- **Abstrahlwinkel:** Lambertscher Strahler (120°)
- **Technologie:** InGaN
- **optischer Wirkungsgrad:** 2 lm/W (blau), 6 lm/W (verde), 8 lm/W (true green)
- **Gruppierungsparameter:** Lichtstärke, Wellenlänge
- **Verarbeitungsmethode:** für alle SMT-Bestücktechniken geeignet
- **Lötmethode:** IR Reflow Löten
- **Vorbehandlung:** nach JEDEC Level 2
- **Gurtung:** 8 mm Gurt mit 3000/Rolle, ø180 mm oder 12000/Rolle, ø330 mm
- **ESD-Festigkeit:** ESD-sicher bis 2 kV nach MIL STD 883 D, Method 3015.7

### Anwendungen

- Informationsanzeigen im Außenbereich
- optischer Indikator
- Hinterleuchtung (LCD, Schalter, Tasten, Displays, Werbebeleuchtung, Allgemeinbeleuchtung)
- Innenbeleuchtung im Automobilbereich (z.B. Instrumentenbeleuchtung, u. ä.)
- Markierungsbeleuchtung (z.B. Stufen, Fluchtwege, u.ä.)
- Signal- und Symbolleuchten
- Scanner

### Features

- **package:** white SMT package
- **feature of the device:** small package for applications where small space is required
- **wavelength:** 470 nm (blue), 505 nm (verde), 528 nm (true green)
- **viewing angle:** Lambertian Emitter (120°)
- **technology:** InGaN
- **optical efficiency:** 2 lm/W (blue), 6 lm/W (verde), 8 lm/W (true green)
- **grouping parameter:** luminous intensity, wavelength
- **assembly methods:** suitable for all SMT assembly methods
- **soldering methods:** IR reflow soldering
- **preconditioning:** acc. to JEDEC Level 2
- **taping:** 8 mm tape with 3000/reel, ø180 mm or 12000/reel, ø330 mm
- **ESD-withstand voltage:** up to 2 kV acc. to MIL STD 883 D, Method 3015.7

### Applications

- outdoor displays
- optical indicators
- backlighting (LCD, switches, keys, displays, illuminated advertising, general lighting)
- interior automotive lighting (e.g. dashboard backlighting, etc.)
- marker lights (e.g. steps, exit ways, etc.)
- signal and symbol luminaire
- scanners

<b>Type</b>	<b>Emissionsfarbe</b>	<b>Farbe der Lichtaustrittsfläche</b>	<b>Lichtstärke</b>	<b>Lichtstrom</b>	<b>Bestellnummer</b>
<b>Type</b>	<b>Color of Emission</b>	<b>Color of the Light Emitting Area</b>	<b>Luminous Intensity <math>I_F = 20 \text{ mA}</math> <math>I_V \text{ (mcd)}</math></b>	<b>Luminous Flux <math>I_F = 20 \text{ mA}</math> <math>\Phi_V \text{ (lm)}</math></b>	<b>Ordering Code</b>
LB M673-M1N1-1	blue	colorless clear	18.0 ... 35.5	77 (typ.)	Q62703-Q4840
LB M673-N1P2-1			28.0 ... 71.0	140 (typ.)	Q62703-Q4889
LB M673-M1			18.0 ... 22.4	60 (typ.)	
LB M673-M2			22.4 ... 28.0	75 (typ.)	
LB M673-N1			28.0 ... 35.5	95 (typ.)	
LB M673-N2			35.5 ... 45.0	120 (typ.)	
LB M673-P1			45.0 ... 56.0	150 (typ.)	
LB M673-P2			56.0 ... 71.0	190 (typ.)	
LV M673-P2Q2-1	verde	colorless clear	56 ... 112	240 (typ.)	Q62703-Q4847
LV M673-Q2S1-1			90 ... 224	440 (typ.)	Q62703-Q4893
LV M673-P2			56 ... 71	190 (typ.)	
LV M673-Q1			71 ... 90	240 (typ.)	
LV M673-Q2			90 ... 112	300 (typ.)	
LV M673-R1			112 ... 140	380 (typ.)	
LV M673-R2			140 ... 180	480 (typ.)	
LV M673-S1			180 ... 224	600 (typ.)	
LT M673-Q1R1-1	true green	colorless clear	71 ... 140	310 (typ.)	Q62703-Q4853
LT M673-R1S2-1			112 ... 280	560 (typ.)	Q62703-Q4897
LT M673-Q1			71 ... 90	240 (typ.)	
LT M673-Q2			90 ... 112	300 (typ.)	
LT M673-R1			112 ... 140	380 (typ.)	
LT M673-R2			140 ... 180	480 (typ.)	
LT M673-S1			180 ... 224	600 (typ.)	
LT M673-S2			224 ... 280	760 (typ.)	

Helligkeitswerte werden mit einer Stromeinprägedauer von 25 ms und einer Genauigkeit von  $\pm 11 \%$  ermittelt.

Luminous intensity is tested at a current pulse duration of 25 ms and an accuracy of  $\pm 11 \%$ .

-1 Farbselektiert nach Wellenlängengruppen (siehe Seite 4).

-1 Color selection acc. to Wavelength groups (see page 4)

**Grenzwerte  
Maximum Ratings**

Bezeichnung Parameter	Symbol Symbol	Wert Value		Einheit Unit
		LB	LV, LT	
Betriebstemperatur Operating temperature range	$T_{op}$	- 40 ... + 100		°C
Lagertemperatur Storage temperature range	$T_{stg}$	- 40 ... + 100		°C
Sperrschichttemperatur Junction temperature	$T_j$	+ 110	+ 125	°C
Durchlassstrom Forward current	$I_F$	20		mA
Stoßstrom Surge current $t \leq 10 \mu s, D = 0.005$	$I_{FM}$	200	250	A
Sperrspannung Reverse voltage	$V_R$	5		V
Leistungsaufnahme Power dissipation $T_A \leq 25 \text{ °C}$	$P_{tot}$	85		mW
Wärmewiderstand Thermal resistance Sperrschicht/Umgebung Junction/ambient Sperrschicht/Löt­pad Junction/solder point Montage auf PC-Board FR 4 (Padgröße $\geq 16 \text{ mm}^2$ ) mounted on PC board FR 4 (pad size $\geq 16 \text{ mm}^2$ )	$R_{th JA}$  $R_{th JS}$	480	230	K/W  K/W

**Kennwerte** ( $T_A = 25\text{ °C}$ )

**Characteristics**

Bezeichnung Parameter	Symbol Symbol	Werte Values			Einheit Unit
		LB	LV	LT	
Wellenlänge des emittierten Lichtes Wavelength at peak emission $I_F = 20\text{ mA}$	(typ.) $\lambda_{\text{peak}}$	465	503	523	nm
Dominantwellenlänge <sup>1)</sup> Dominant wavelength <sup>1)</sup> $I_F = 20\text{ mA}$	(typ.) $\lambda_{\text{dom}}$	470 $\pm 7$	505 $\pm 8$	528 $\pm 10$	nm
Spektrale Bandbreite bei 50 % $I_{\text{rel max}}$ Spectral bandwidth at 50 % $I_{\text{rel max}}$ $I_F = 20\text{ mA}$	(typ.) $\Delta\lambda$	25	30	33	nm
Abstrahlwinkel bei 50 % $I_V$ (Vollwinkel) Viewing angle at 50 % $I_V$	(typ.) $2\phi$	120	120	120	Grad deg.
Durchlassspannung Forward voltage $I_F = 20\text{ mA}$	(typ.) $V_F$ (max.) $V_F$	3.5 4.2	3.3 4.2	3.3 4.2	V V
Sperrstrom Reverse current $V_R = 5\text{ V}$	(typ.) $I_R$ (max.) $I_R$	0.01 10	0.01 10	0.01 10	$\mu\text{A}$ $\mu\text{A}$
Temperaturkoeffizient von $\lambda_{\text{peak}}$ Temperature coefficient of $\lambda_{\text{peak}}$ $I_F = 20\text{ mA}$	(typ.) $TC_{\lambda_{\text{peak}}}$	0.04	0.03	0.04	nm/K
Temperaturkoeffizient von $\lambda_{\text{dom}}$ Temperature coefficient of $\lambda_{\text{dom}}$ $I_F = 20\text{ mA}$	(typ.) $TC_{\lambda_{\text{dom}}}$	0.02	0.02	0.03	nm/K
Temperaturkoeffizient von $V_F$ Temperature coefficient of $V_F$ $I_F = 20\text{ mA}$	(typ.) $TC_V$	- 2.9	- 3.2	- 3.6	mV/K
Optischer Wirkungsgrad Optical efficiency $I_F = 20\text{ mA}$	(typ.) $\eta_{\text{opt}}$	2	6	8	lm/W

<sup>1)</sup> **Wellenlängengruppen / Wavelength groups**

Gruppe Group	blue		verde		true green	
	min.	max.	min.	max.	min.	max.
3	464	468	498	503	519	525
4	468	472	503	507	525	531
5	472	476	507	512	531	537

Wellenlängengruppen werden mit einer Stromeinprägedauer von 25 ms und einer Genauigkeit von  $\pm 1\text{ nm}$  ermittelt.

Wavelength groups are tested at a current pulse duration of 25 ms and an accuracy of  $\pm 1\text{ nm}$ .

Relative spektrale Emission  $I_{rel} = f(\lambda)$ ,  $T_A = 25\text{ °C}$ ,  $I_F = 20\text{ mA}$

**Relative Spectral Emission**

$V(\lambda)$  = spektrale Augenempfindlichkeit

Standard eye response curve

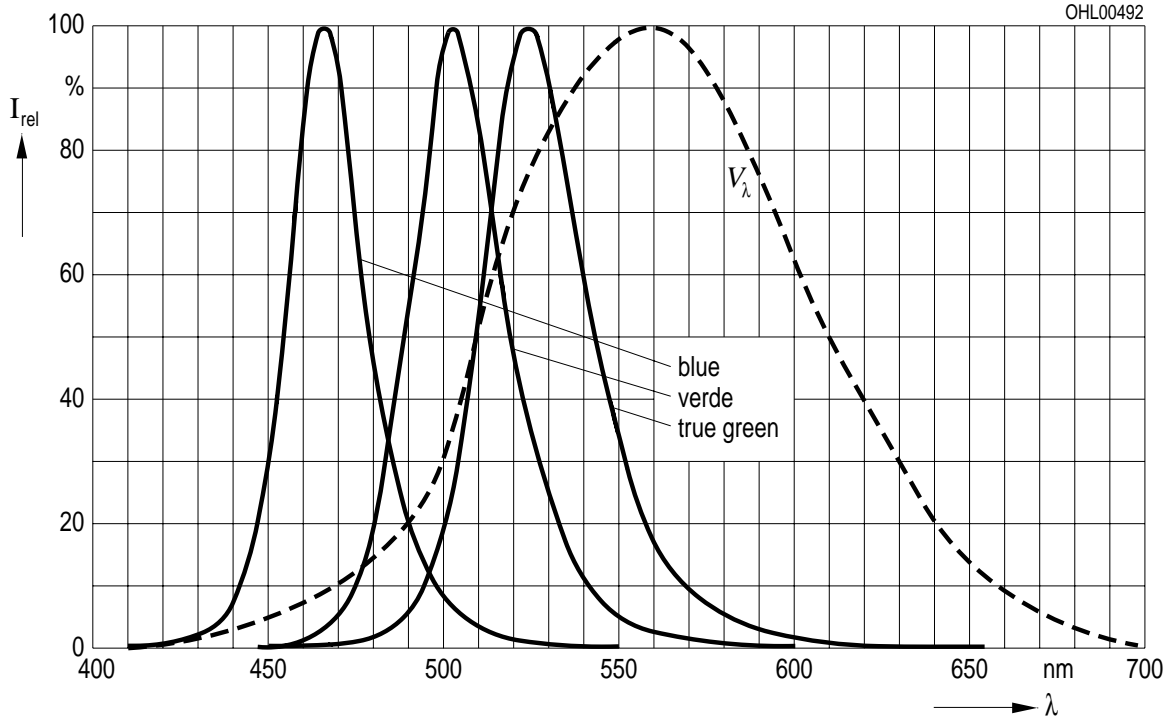

Abstrahlcharakteristik  $I_{rel} = f(\varphi)$

**Radiation Characteristic**

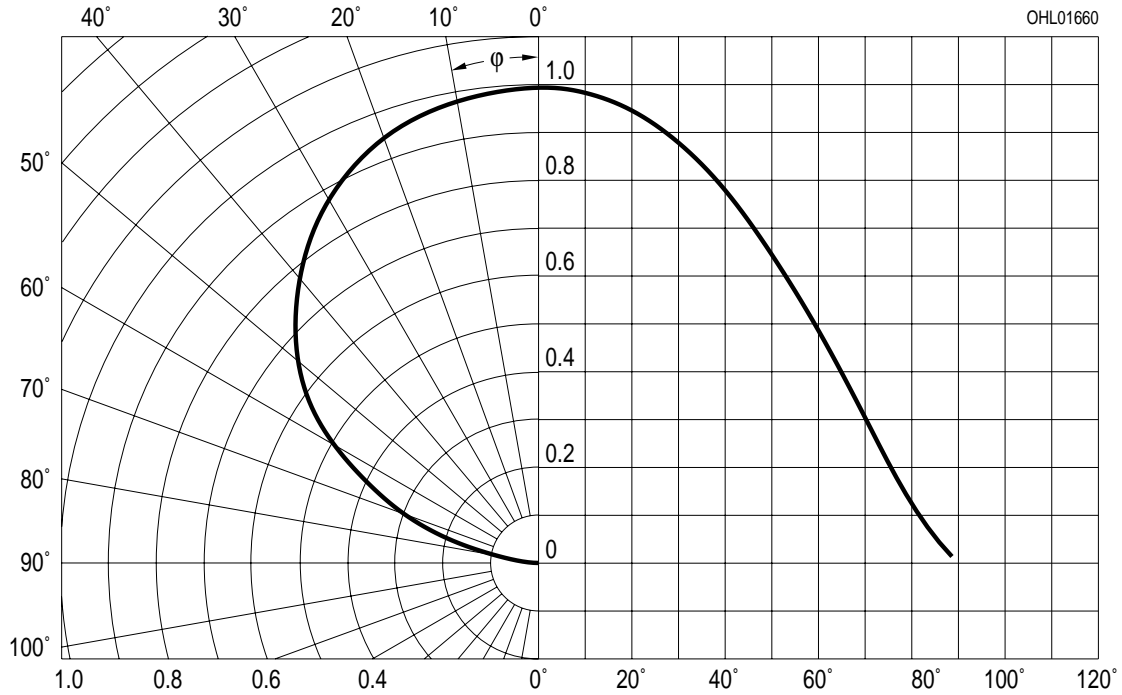

**Durchlassstrom  $I_F = f(V_F)$**

**Forward Current**

$T_A = 25\text{ °C}$

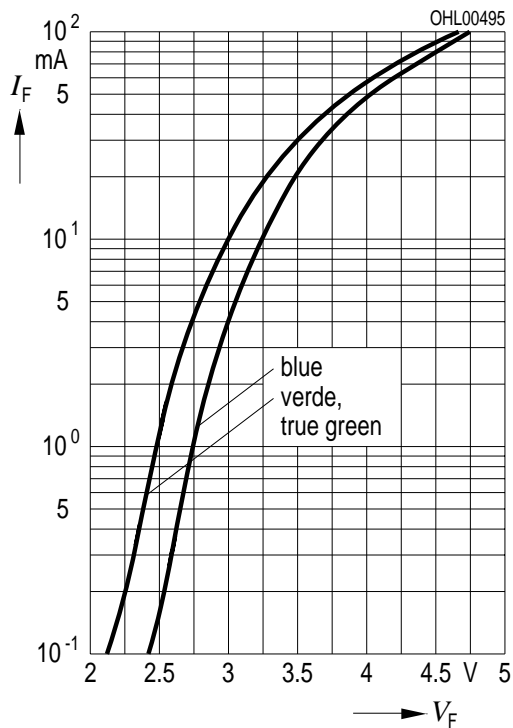

**Relative Lichtstärke  $I_V/I_{V(20\text{ mA})} = f(I_F)$**

**Relative Luminous Intensity**

$T_A = 25\text{ °C}$

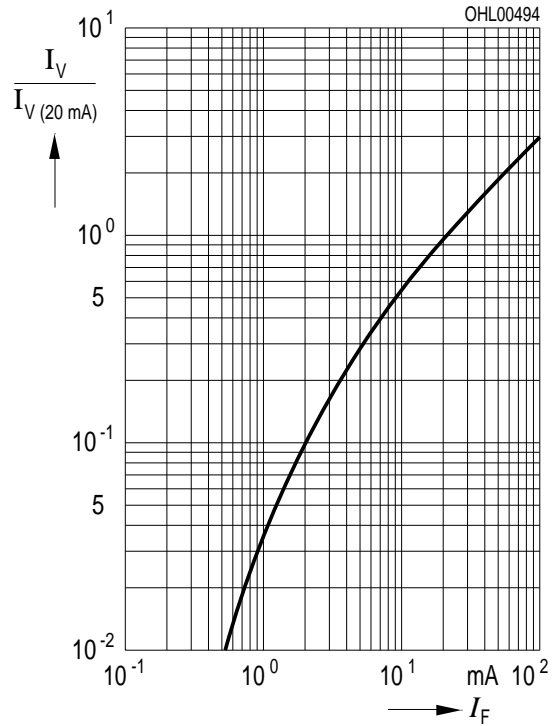

**Maximal zulässiger Durchlassstrom  $I_F = f(T)$**

**Max. Permissible Forward Current**

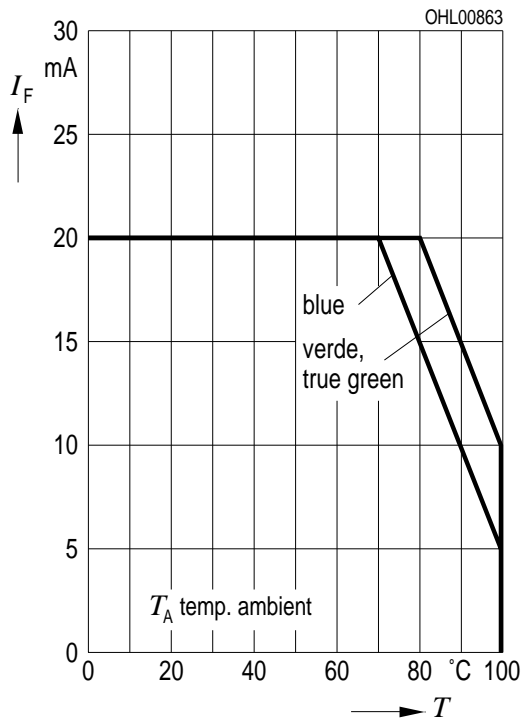

**Maximal zulässiger Durchlassstrom  $I_F = f(T)$**

**Max. Permissible Forward Current**

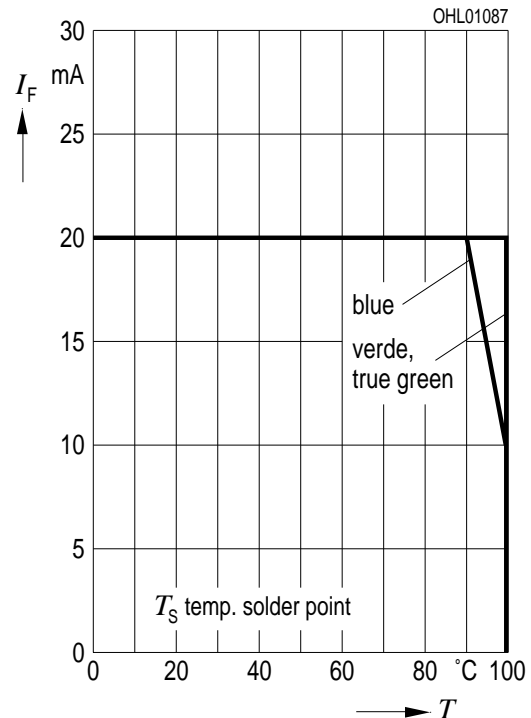

Relative Lichtstärke  $I_V/I_{V(25^\circ\text{C})} = f(T_A)$

Relative Luminous Intensity

$I_F = 20 \text{ mA}$

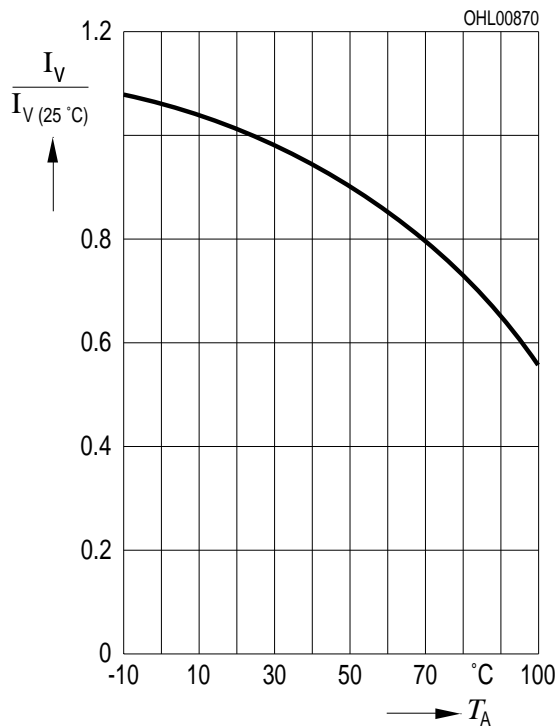

Dominante Wellenlänge  $\lambda_{\text{dom}} = f(I_F)$

Dominant Wavelength

LB,  $T_A = 25^\circ\text{C}$

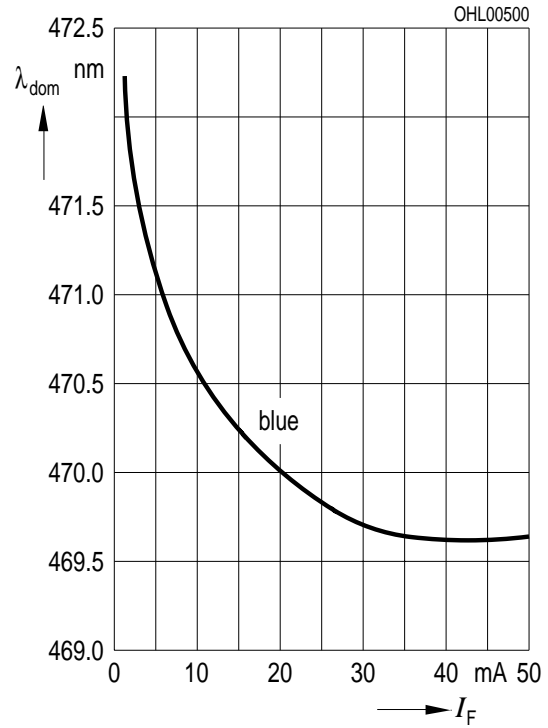

Dominante Wellenlänge  $\lambda_{\text{dom}} = f(I_F)$

Dominant Wavelength

LV,  $T_A = 25^\circ\text{C}$

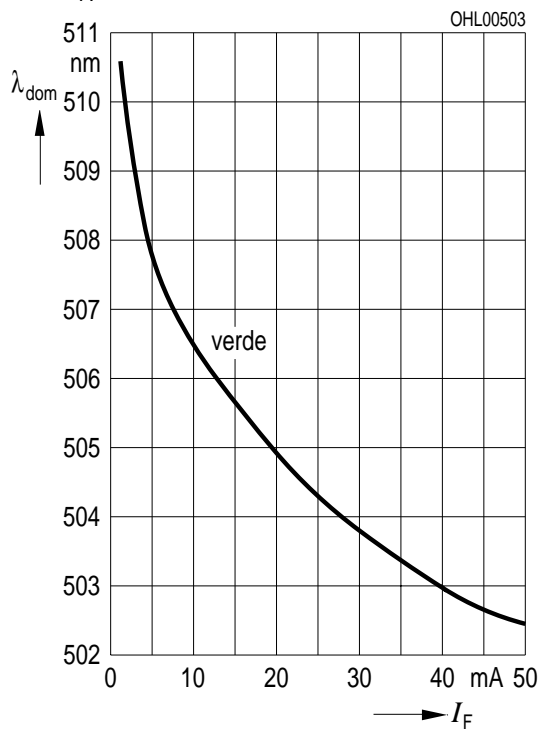

Dominante Wellenlänge  $\lambda_{\text{dom}} = f(I_F)$

Dominant Wavelength

LT,  $T_A = 25^\circ\text{C}$

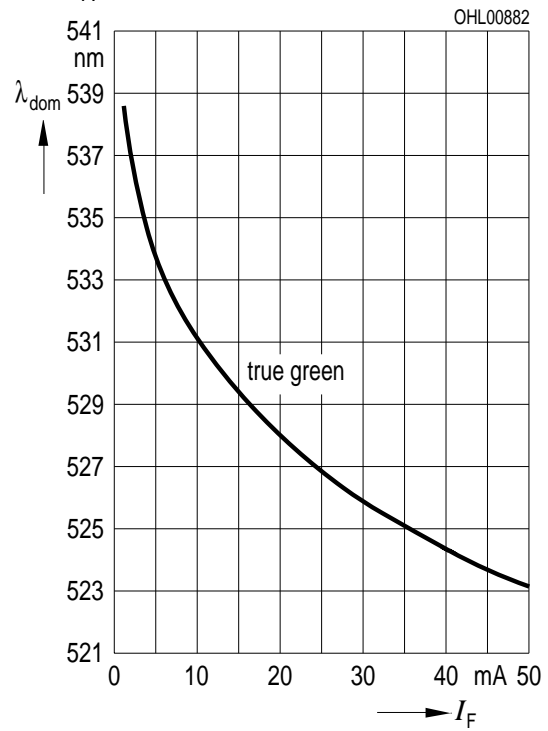

**Zulässige Impulsbelastbarkeit  $I_F = f(t_p)$**   
**Permissible Pulse Handling Capability**  
 Duty cycle  $D =$  parameter,  $T_A = 25\text{ °C}$   
**LB**

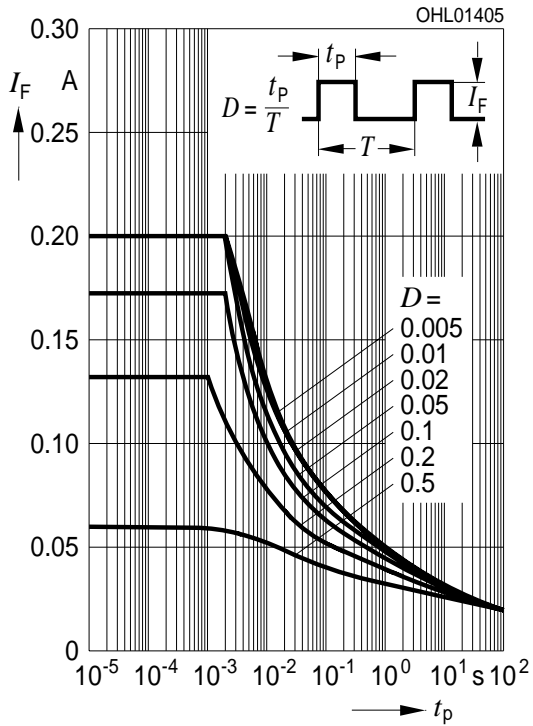

**Zulässige Impulsbelastbarkeit  $I_F = f(t_p)$**   
**Permissible Pulse Handling Capability**  
 Duty cycle  $D =$  parameter,  $T_A = 85\text{ °C}$   
**LB**

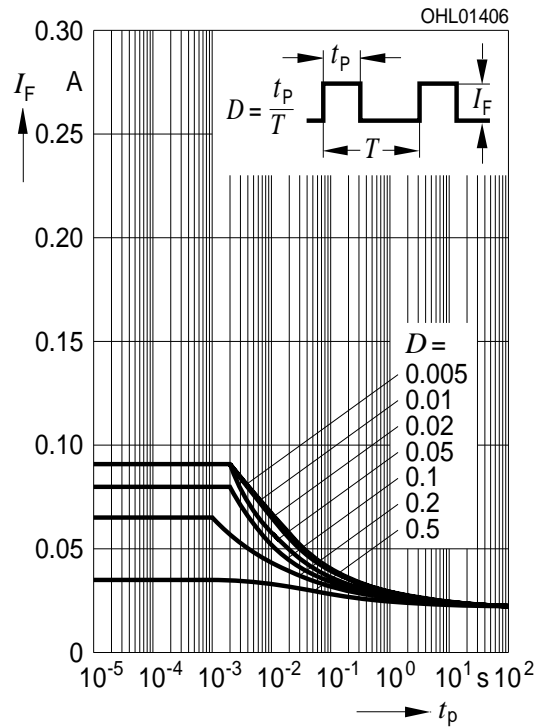



**Zulässige Impulsbelastbarkeit  $I_F = f(t_p)$**   
**Permissible Pulse Handling Capability**  
 Duty cycle  $D =$  parameter,  $T_A = 25\text{ °C}$   
**LV, LT**

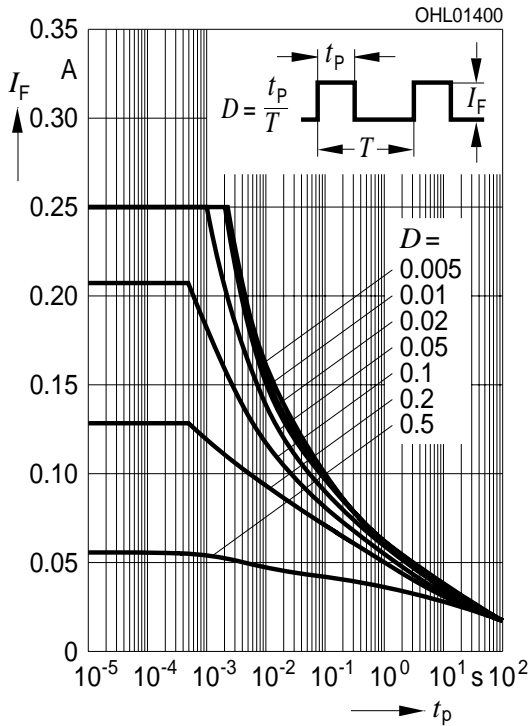

**Zulässige Impulsbelastbarkeit  $I_F = f(t_p)$**   
**Permissible Pulse Handling Capability**  
 Duty cycle  $D =$  parameter,  $T_A = 85\text{ °C}$   
**LV, LT**

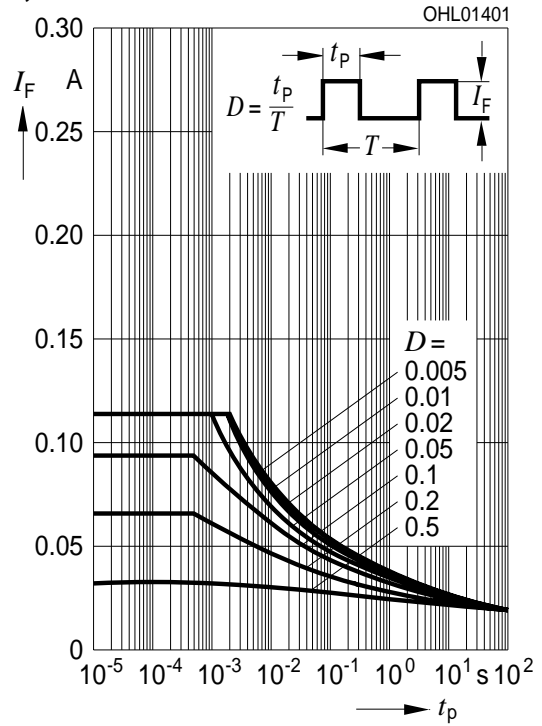

Maßzeichnung  
Package Outlines

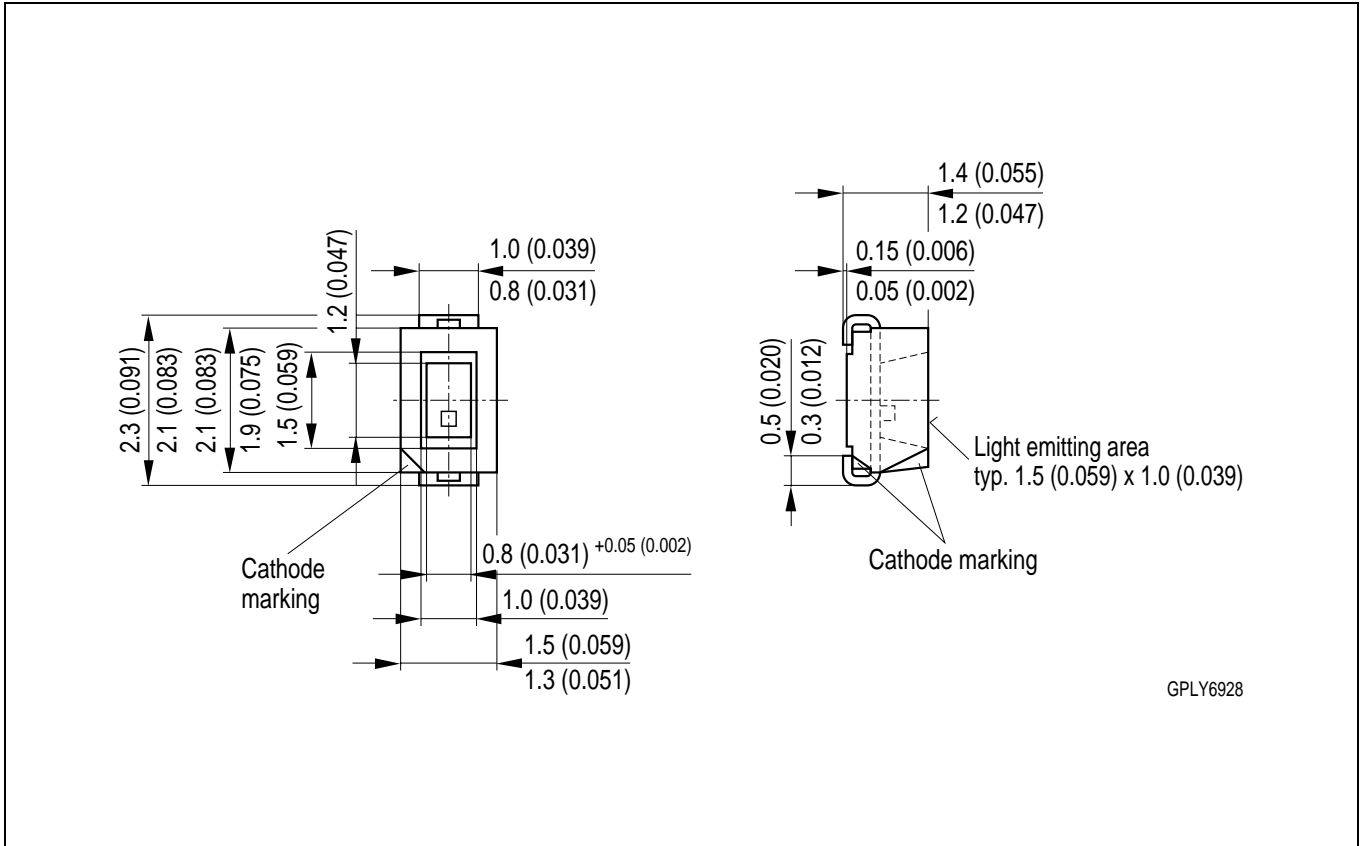

Maße werden wie folgt angegeben: mm (inch) / Dimensions are specified as follows: mm (inch).

**Kathodenkennung:** abgeschrägte Ecke  
**Cathode mark:** bevelled edge

**Lötbedingungen** Vorbehandlung nach JEDEC Level 2  
**Soldering Conditions** Preconditioning acc. to JEDEC Level 2

**IR-Reflow Lötprofil** (nach IPC 9501)  
**IR Reflow Soldering Profile** (acc. to IPC 9501)

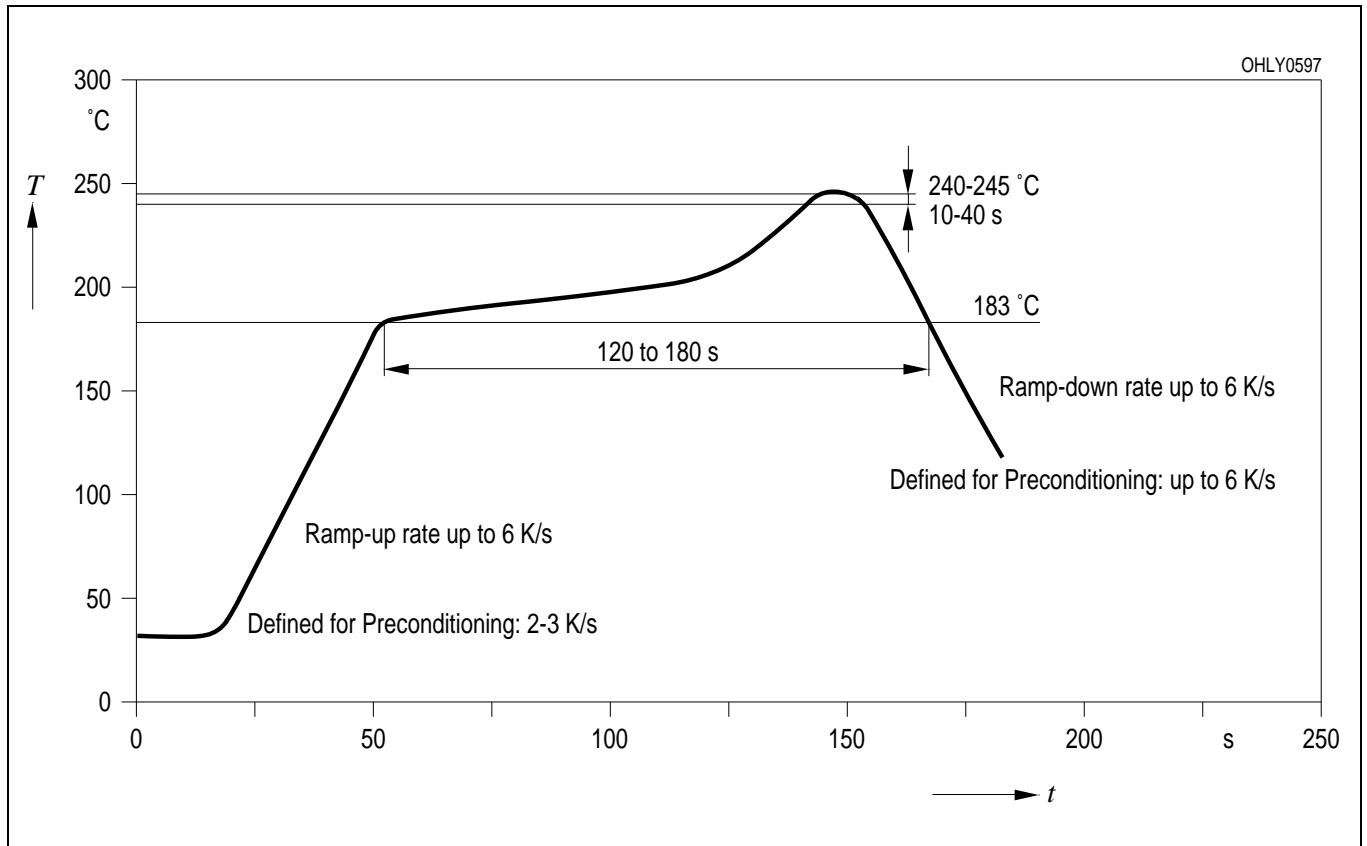

**Empfohlenes Lötpad Design** IR Reflow Löten  
**Recommended Solder Pad** IR Reflow Soldering

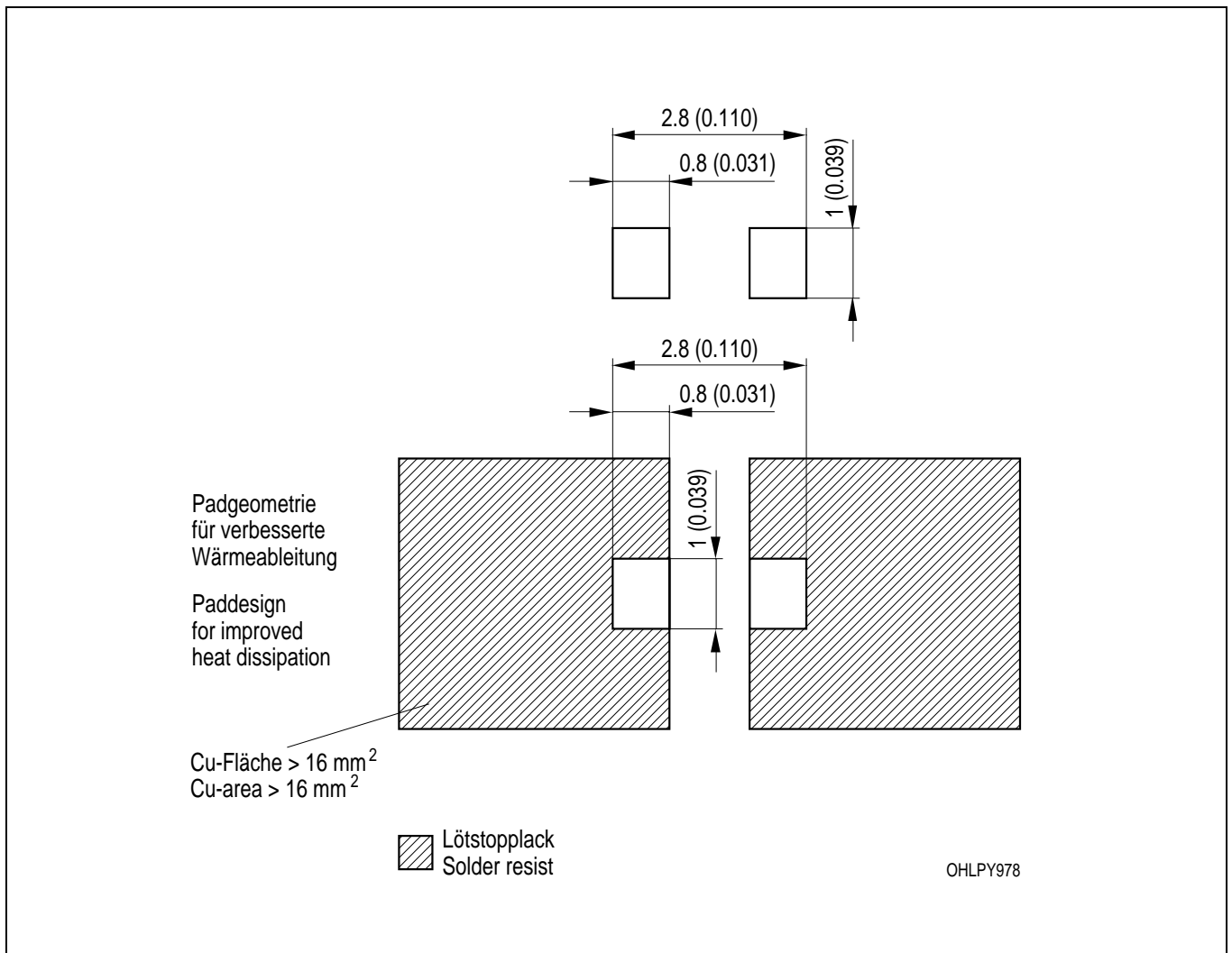

Maße werden wie folgt angegeben: mm (inch) / Dimensions are specified as follows: mm (inch).

**Gurtung / Polarität und Lage**

Verpackungseinheit 3000/Rolle,  $\varnothing$ 180 mm  
oder 12000/Rolle,  $\varnothing$ 330 mm

**Method of Taping / Polarity and Orientation**

Packing unit 3000/reel,  $\varnothing$ 180 mm  
or 12000/reel,  $\varnothing$ 330 mm

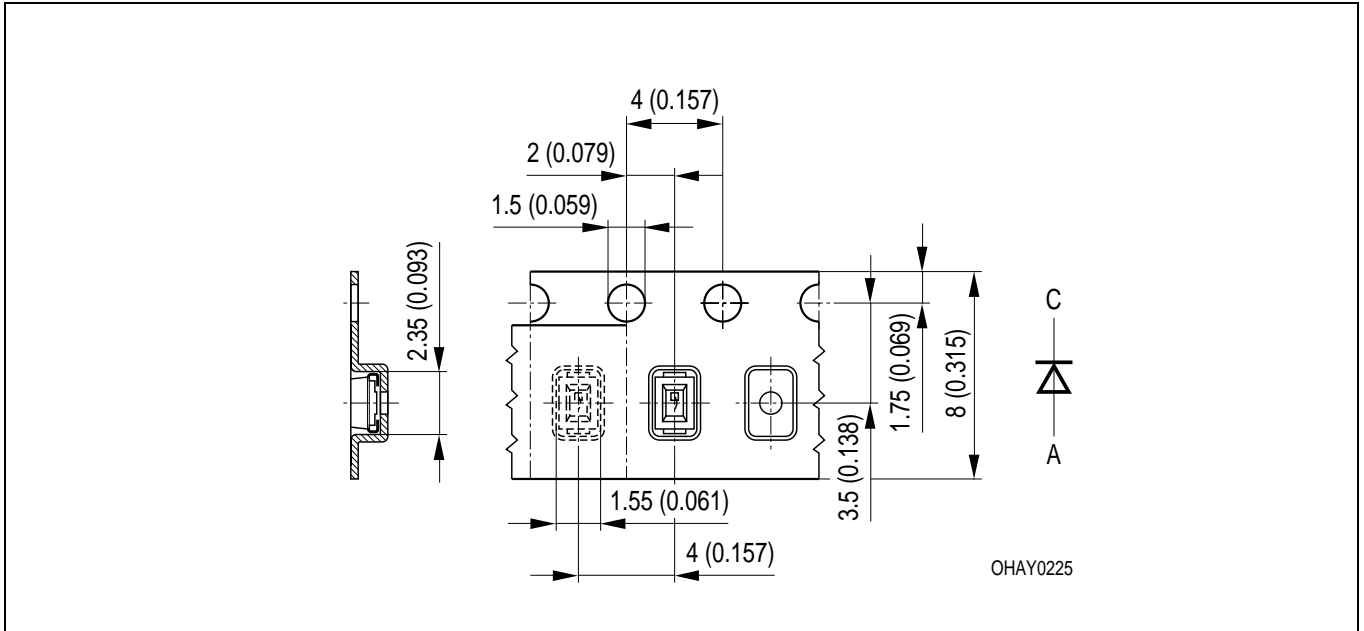

Maße werden wie folgt angegeben: mm (inch) / Dimensions are specified as follows: mm (inch).