

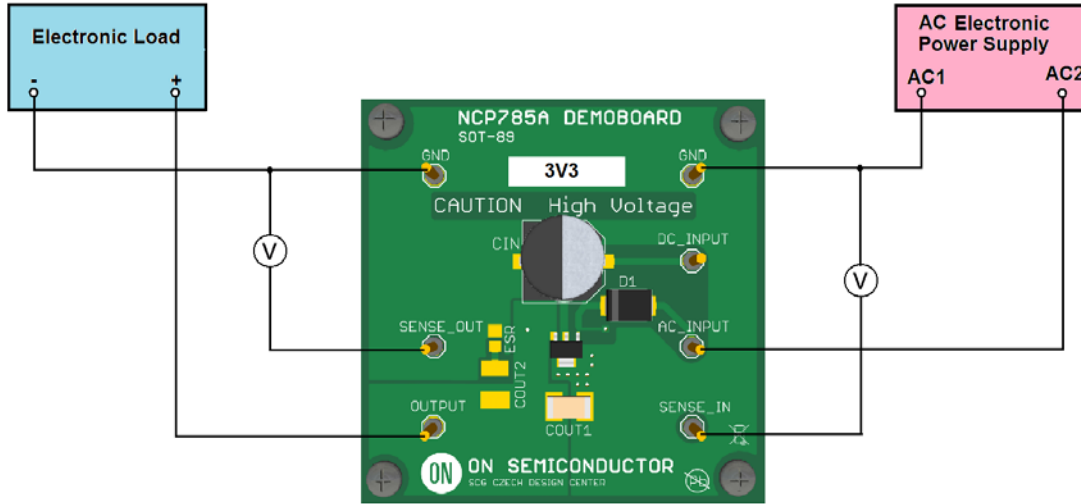

Test Procedure for NCP785AH33GEVB



Test procedure:

1. Connect the test setup as shown Figure above
2. Apply an input AC voltage $V_{in} = 85 \text{ Vac}$
4. Apply $I_{out} = 0 \text{ mA}$ load.
5. Check that V_{out} is $3.3 \text{ V} \pm 5\%$.
6. Increase I_{out} up to 10 mA
7. Check that V_{out} is $3.3 \text{ V} \pm 5\%$.
7. Increase V_{in} up to 235 Vac and decrease the load in accordance with SOA
8. Power down the Load
9. Power down the Input Voltage
10. End of test