

CARMEN-RS-C

~10° spot beam. Assembly with holder C compatible with LEDiL HEKLA.

TECHNICAL SPECIFICATIONS:

Dimensions	Ø 69.5 mm
Height	41.5 mm
Fastening	socket
Colour	black
Box size	480 x 280 x 300 mm
Box weight	6.2 kg
Quantity in Box	150 pcs
ROHS compliant	yes ⓘ







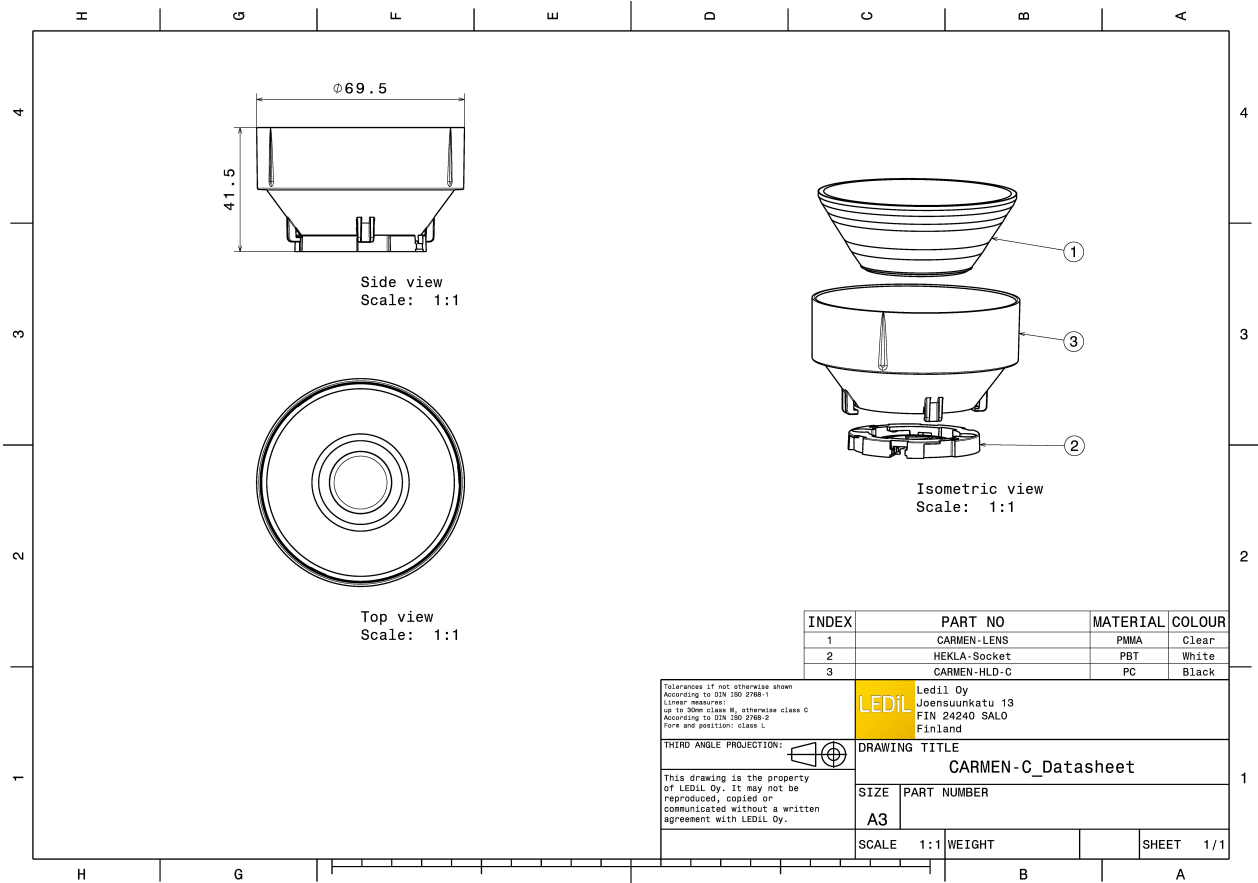

MATERIAL SPECIFICATIONS:

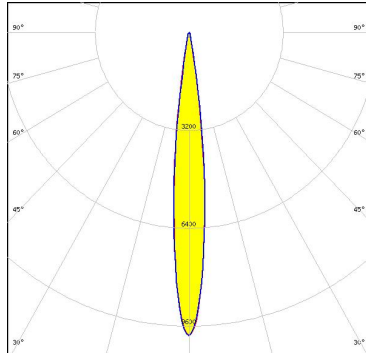
Component	Type	Material	Colour
CARMEN-RS	Lens	PMMA	clear
CARMEN-HLD-C	Holder	PC	black

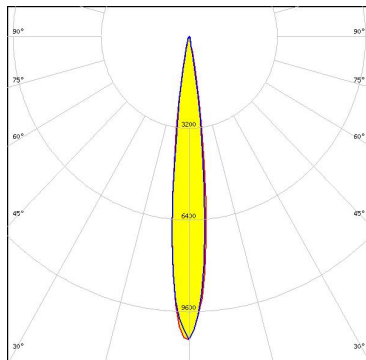

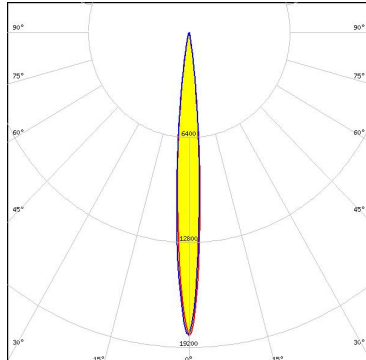
PHOTOMETRIC DATA (MEASURED):

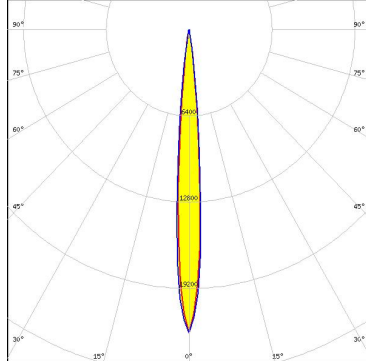
<p>bridgelux</p> <p>LED VERO10 FWHM 12.0° Efficiency 61 % Peak intensity 9.900 cd/lm Required components: F15616_HEKLA-SOCKET-F</p>		
<p>CITIZEN</p> <p>LED CLL02x/CLU02x (LES10) FWHM 13.0° Efficiency 59 % Peak intensity 8.600 cd/lm Required components: F15255_HEKLA-SOCKET-C</p>		
<p>CITIZEN</p> <p>LED CLU LES 4.2mm (HI-Ver.3) FWHM 6.0° Efficiency 65 % Peak intensity 34.700 cd/lm Required components: F15255_HEKLA-SOCKET-C</p>		
<p>CITIZEN</p> <p>LED CLU700/701 FWHM 8.0° Efficiency 62 % Peak intensity 20.200 cd/lm Required components: F15255_HEKLA-SOCKET-C</p>		

PHOTOMETRIC DATA (MEASURED):



LED CMA1516
 FWHM 13.0°
 Efficiency 63 %
 Peak intensity 9.700 cd/lm
 Required components:
 F15256_HEKLA-SOCKET-D

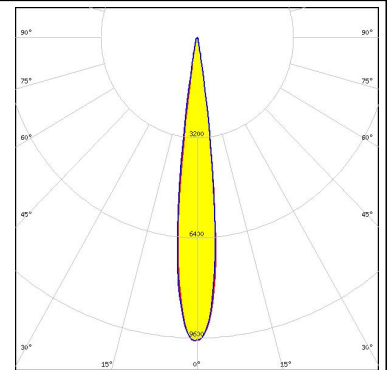
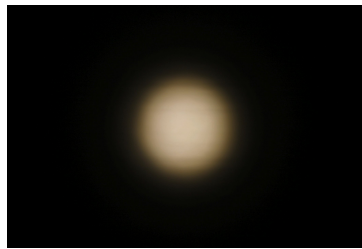

LED CXA/B 13xx
 FWHM 8.0°
 Efficiency 64 %
 Peak intensity 21.400 cd/lm
 Required components:
 F15956_HEKLA-SOCKET-J

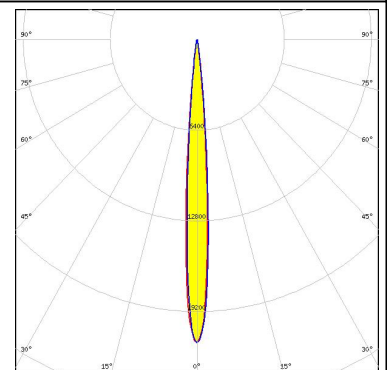

LED LUXEON CoB 1205HD
 FWHM 15.0°
 Efficiency 59 %
 Peak intensity 6.400 cd/lm
 Required components:
 F15858_HEKLA-SOCKET-H

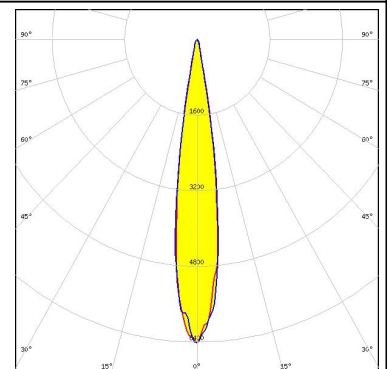
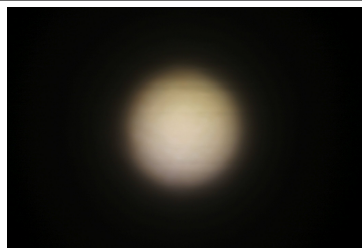

LED CXM-9
 FWHM 13.0°
 Efficiency 59 %
 Peak intensity 9.300 cd/lm
 Required components:
 F15255_HEKLA-SOCKET-C

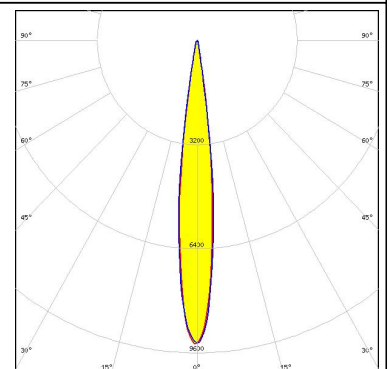

PHOTOMETRIC DATA (MEASURED):

SAMSUNG

LED COB D Series LES 9.8 mm
FWHM 13.0°
Efficiency 60 %
Peak intensity 9.300 cd/lm
Required components:
F15255_HEKLA-SOCKET-C

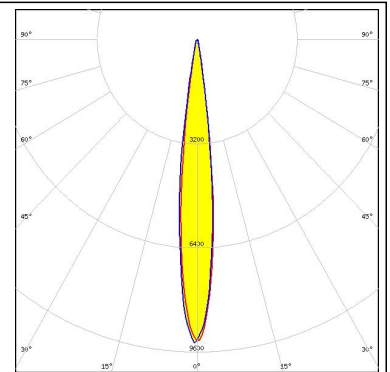
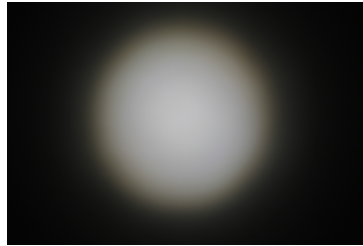



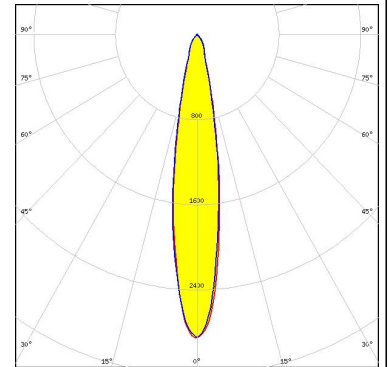
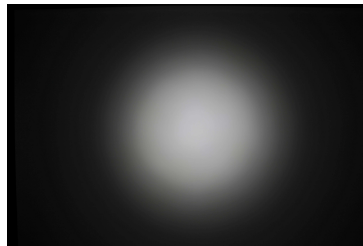

XICATO

LED XTM - 19mm LES
FWHM 18.0°
Efficiency 50 %
Peak intensity 2.900 cd/lm
Required components:
C16058_XTM-ADAPTER-50-C

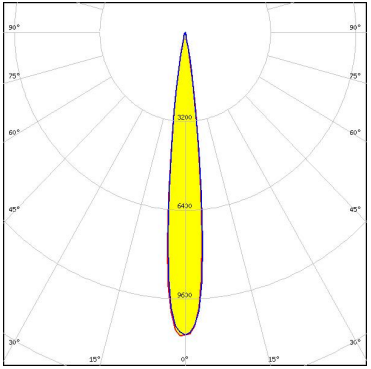
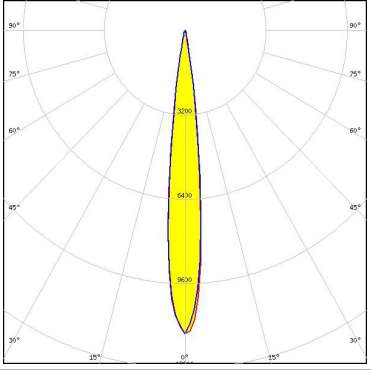
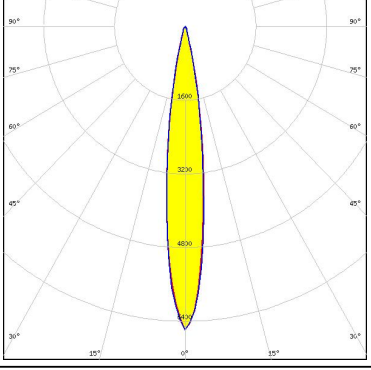

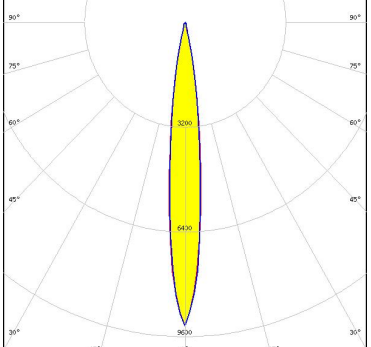
PHOTOMETRIC DATA (SIMULATED):

<p> bridgelux</p> <p>LED V9 HD FWHM 13.0° Efficiency 64 % Peak intensity 11.030 cd/lm Required components: F15859_HEKLA-SOCKET-I</p>	
<p>CITIZEN</p> <p>LED CLU710/711 FWHM 12.0° Efficiency 66 % Peak intensity 11.500 cd/lm Required components: F15859_HEKLA-SOCKET-I</p>	
<p>CITIZEN</p> <p>LED CLU720/721 FWHM 15.0° Efficiency 61 % Peak intensity 6.590 cd/lm Required components: F15859_HEKLA-SOCKET-I</p>	
<p> CREE</p> <p>LED CXA/B 15xx FWHM 12.0° Efficiency 63 % Peak intensity 9.300 cd/lm Required components: F15256_HEKLA-SOCKET-D</p>	 

PHOTOMETRIC DATA (SIMULATED):

LUMILEDS

LED LUXEON CoB Compact
FWHM 10.0°
Efficiency 71 %
Peak intensity 18.000 cd/lm
Required components:
F15848_HEKLA-SOCKET-G

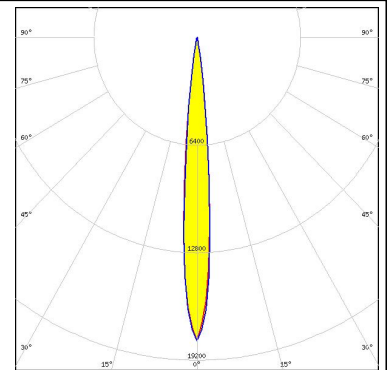

SAMSUNG

LED LC020C
FWHM 12.0°
Efficiency 66 %
Peak intensity 11.700 cd/lm
Required components:
F15848_HEKLA-SOCKET-G

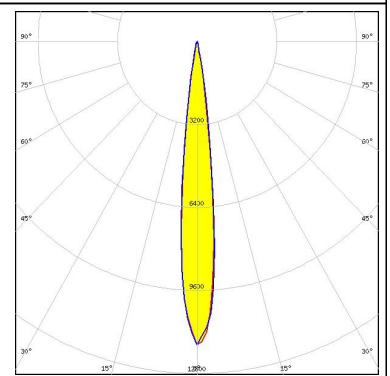

GENERAL INFORMATION:

NOTE: The typical beam angle will be changed by different color, chip size and chip position tolerance. The typical total beam angle is the full angle measured where the luminous intensity is half of the peak value.

Due to use of high power COB's with this product, special attention to proper thermal design is highly recommended. LEDiL has no liability for direct, indirect or consecutive damages arising from the LEDiL products being used outside of the recommended temperature range.

MATERIALS:

As part of our continuous research and improvement processes, and to ensure the best possible quality and availability of our products, LEDiL reserves the right to change material grades without notice.

PRODUCT DATA USER AGREEMENT AND DISCLAIMER:

The measured data in the provided downloadable LEDiL Product Datasheets and Mechanical 2D-Drawings is rounded and provided as reference for planning. LEDiL Oy's optical specifications have been verified by conducting performance testing of the products in accordance with the company's quality system. The reported data are averaged results of multiple measurements with typical variation. LEDiL Oy reserves the right to without prior notification make changes and improvements to its products.

LEDiL Oy assumes neither warranty, nor guarantee nor any other liability of any kind for the contents and correctness of the provided data. The provided data has been generated with highest diligence but the provided data may in reality not represent the complete possible variation range of all intrinsic parameters. Therefore, in certain cases a deviation from the provided data could occur.

LEDiL Oy reserves the right to undertake technical changes of its products without further notification which could lead to changes in the provided data. LEDiL Oy assumes no liability of any kind for the possible deviation from any provided data or any other damage resulting from the usage of the provided data.

The user agrees to this disclaimer and user agreement with the download or usage of the provided files.

LEDiL Oy

Joensuunkatu 13
FI-24240 SALO
Finland

LEDiL Inc.

228 West Page Street
Suite D
Sycamore IL 60178
USA

Local sales and technical support

[www.ledil.com/
where_to_buy](http://www.ledil.com/where_to_buy)

Shipping locations

Salo, Finland
Hong Kong, China

Distribution Partners

[www.ledil.com/
where_to_buy](http://www.ledil.com/where_to_buy)