

# M0116LY-161LSA2

## Vacuum Fluorescent Display Module

RoHS Compliant

**Newhaven Display International, Inc.**

2511 Technology Drive, Suite 101

Elgin IL, 60124

Ph: 847-844-8795

Fax: 847-844-8796

[www.newhavendisplay.com](http://www.newhavendisplay.com)

[nhtech@newhavendisplay.com](mailto:nhtech@newhavendisplay.com)

[nhsales@newhavendisplay.com](mailto:nhsales@newhavendisplay.com)

STANDARD		DOCUMENT NO.	REV.NO	PAGE
		M0116LY-161LSA2	02	2 of 11

## 1. INTRODUCTION

The M0116LY-161LSA2 Vacuum Fluorescent Display module consists of a 1 row x 16 digit display with one chip controller on board.

## 2. FEATURES

- 2.1 Simple connection to the host system data bus via two-wire clocked serial interface.
- 2.2 Since a DC/DC converter is used, only +12Vdc power source is required to operate the module.
- 2.3 One chip controller offers integral 64×16 bit programmable logic array, low power consumption and high reliability in services.
- 2.4 32 brightness levels can be selected by brightness control command.
- 2.5 High quality blue-green(505nm) vacuum fluorescent display provides an attractive and readable medium. Other colors can be achieved by simple wavelength filters.
- 2.6 Characters are provided in an attractive 16-segment starburst format.

## 3. GENERAL DESCRIPTIONS

- 3.1 This specification becomes effective after being approved by the purchaser.
- 3.2 When any conflict is found in the specification ,appropriate action shall be taken upon agreement of both parties.
- 3.3 The expected necessary service parts should be arranged by the customer before the completion of production.

## 4. PRODUCT SPECIFICATIONS

### 4.1 Type

Table-1

<b>Type</b>	<b>M0116LY-161LSA2</b>
Digit Format	16 Seg. & Comma, Decimal Point

### 4.2 Outer Dimensions, Weight (See Fig-4 on Page 4/12 for details)

Table-2

Parameter		Specification	Unit
Outer Dimensions	Width	218.0±1.0	mm
	Height	45.0±1.0	mm
	Thickness	26.5 Max	mm
Weight		Typical 130	g

STANDARD		DOCUMENT NO.	REV.NO	PAGE
		M0116LY-161LSA2	02	3 of 11

#### 4.3 Specification of Display Panel (See Fig-5 on Page 5/13)

Table-3

Parameter	Symbol	Specification	Unit
Display Size (W×H)	-	173.6×14.25	mm
Number of Digit	-	16 Digits	-
Character Size (W×H)	-	7.0×12.50	mm
Character Pitch	C <sub>p</sub> (x)	11.0	mm
Display Color	-	Blue-Green (Peak 505 nm)	mm

#### 4.4 Environment Conditions

Table-4

Parameter	Symbol	Min	Max	Unit
Operating Temperature	Topr	-40	+85	°C
Storage Temperature	Tstg	-50	+95	°C
Humidity (Operating)	Hopr	0	85	%
Humidity (Non-operating)	Hstg	0	90	%
Vibration (10~55Hz)	-	-	4	G
Shock	-	-	40	G

#### 4.5 Absolute Maximum Ratings

Table-5

Parameter	Symbol	Min	Max.	Unit
Supply Voltage	V <sub>cc</sub>	-	15.0	V <sub>dc</sub>
Input Signal Voltage	V <sub>is</sub>	-0.4	5.5	V <sub>dc</sub>

#### 4.6 Recommend Operating Conditions

Table-6

Parameter	Symbol	Min	Typ.	Max.	Unit
Supply Voltage	V <sub>cc</sub>	10.8	12.0	13.2	V <sub>dc</sub>
H-Level Input Voltage	V <sub>ih</sub>	2.0	-	-	V <sub>dc</sub>
L-Level Input Voltage	V <sub>il</sub>	-	-	0.8	V <sub>dc</sub>

#### 4.7 DC Characteristics (T<sub>a</sub>=+25°C, V<sub>cc</sub>=+12.0V<sub>dc</sub>)

Table-7

Parameter	Symbol	Min.	Typ.	Max.	Unit
Supply current ※)	I <sub>cc</sub>	-	300	400	mA
H-Level Input Current	I <sub>ih</sub>	-	-	20.0	μA
L-Level Input Current	I <sub>il</sub>	-	-	-0.36	μA
Lumilance	L	100	200	-	ft-L

※) The surge current can be approx. 3 times the specified supply current at power on.

#### 4.8 Timing Chart

##### 4.8.1 SCLK and DATA Timing

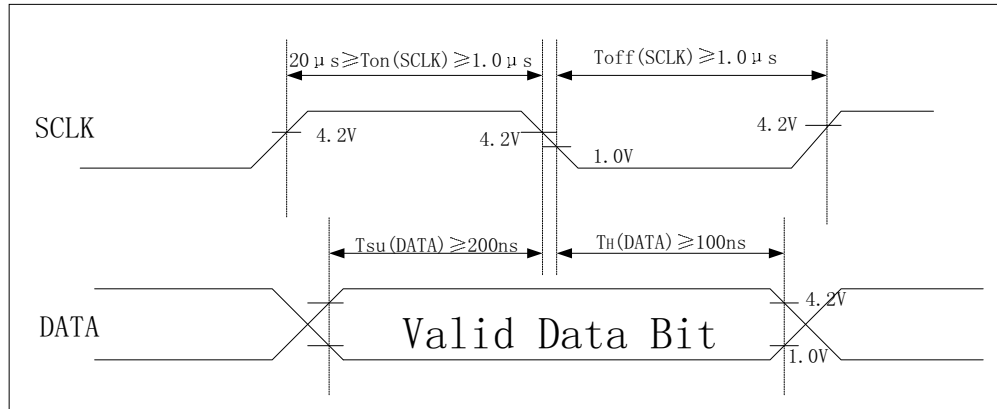

Fig-1. SCLK and Serial DATA Timing Diagram

##### 4.8.2 Data word LSB/MSB Timing

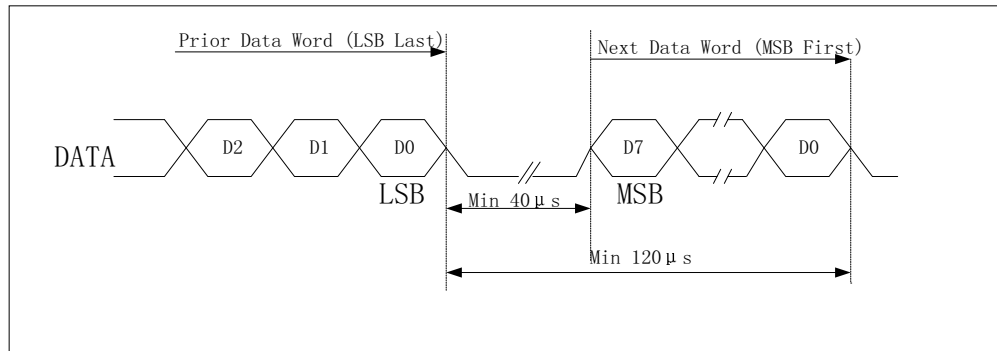

Fig-2 Data Word LSB/MSB Timing Diagram

#### 4.9 Signal Interfacing

Connector (Male): PH-2S06-FG (by Aster) or equivalent

→ Make Socket(Female) : HIF3B-12D-2.54R (HIOROSE) or equivalent

Table-8

Pin #	Signal	Pin #	Signal	Signal Name Description
1	Vcc	2	Vcc	<b>Vcc : Power Supply Terminal. (+12Vdc is required.)</b>
3	N/C	4	N/C	<b>N/C : No Connection.</b>
5	N/C	6	N/P	<b>N/P : No Pin</b>
7	N/C	8	SCLK	<b>SCLK : Shift Clock of Shift Register. (Falling Edge Active)</b>
9	DATA	10	/RST	<b>DATA :Input Terminal for Display or Control Codes. /RST :Input Terminal for Reset of VFD Module. (Low Active)</b>
11	GND	12	GND	<b>GND : Ground Terminal.</b>

4.10 System Block Diagram

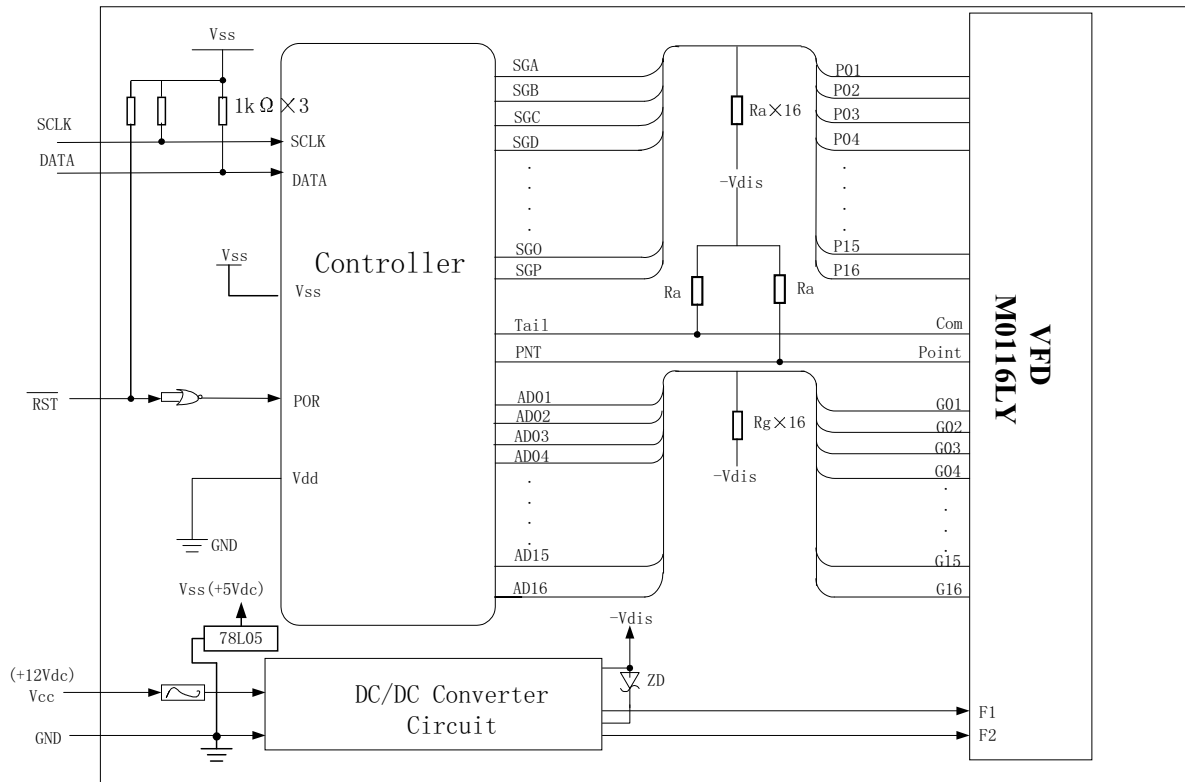

Fig-3 VFD Module System Block Diagram

4.11 Outer Dimensions

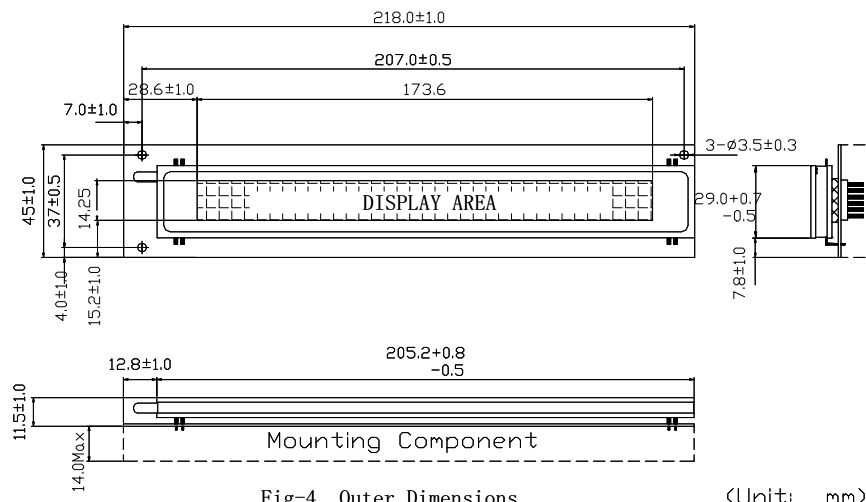

Fig-4. Outer Dimensions

(Unit: mm)

4.12 Pattern Details

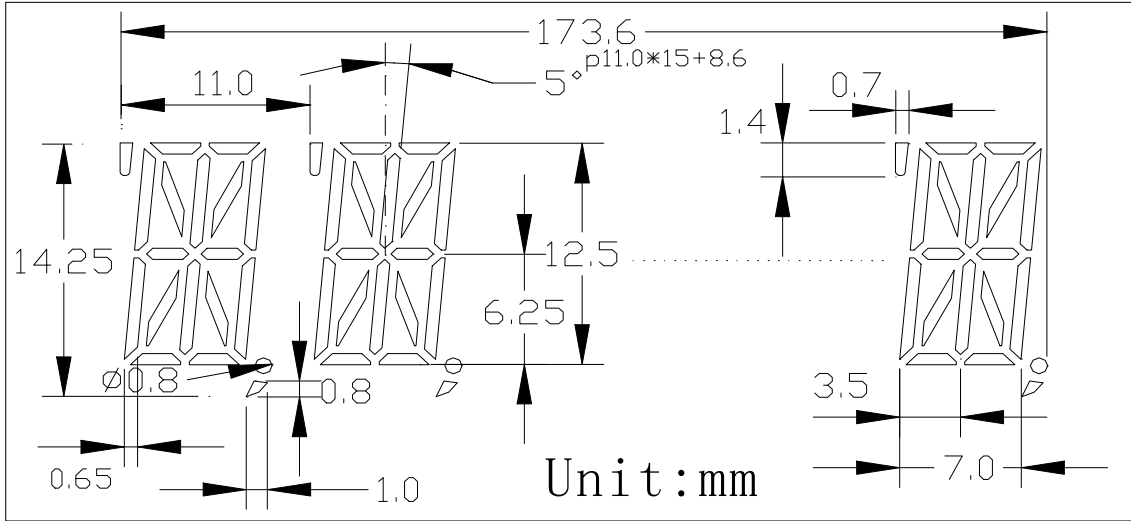

Fig-5. Pattern Details

5 FUNCTIONS

The module has control data, display data write and reset functions.

Input data from the host system is loaded into the module's display buffer via the serial data input channel as 8-bit serial data.

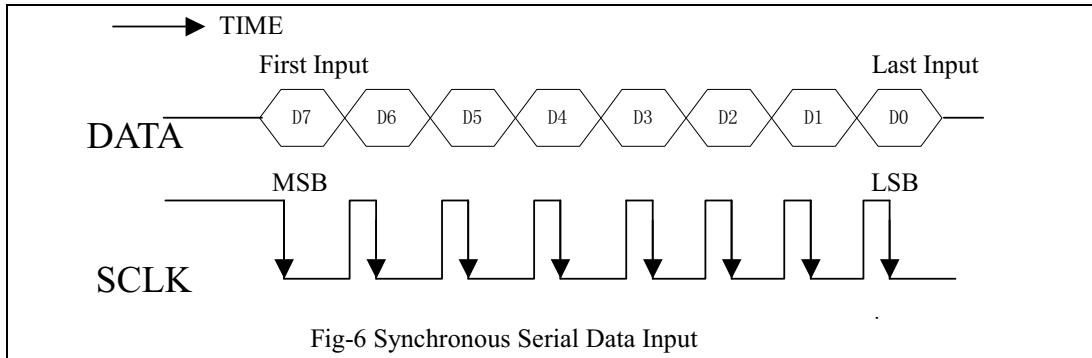

Fig-6 Synchronous Serial Data Input

The MSB value of 8-bit serial data determines whether the input data into this module is control data or display data.

5.1 Control Data

The control data can be input by setting MSB to "1" : In addition, a command type and associated data with the command is determined by the D6~D0.

Command	Function	Binary Code							
		D7	D6	D5	D4	D3	D2	D1	D0
Buffer Pointer Control	Specifies the RAM address.	1	0	1	0	2 <sup>3</sup>	2 <sup>2</sup>	2 <sup>1</sup>	2 <sup>0</sup>
Digit Counter Control	Sets the number of digits.	1	1	0	0	2 <sup>3</sup>	2 <sup>2</sup>	2 <sup>1</sup>	2 <sup>0</sup>
Brightness Control	Sets the brightness.	1	1	1	2 <sup>4</sup>	2 <sup>3</sup>	2 <sup>2</sup>	2 <sup>1</sup>	2 <sup>0</sup>

### 5.1.1 Buffer Pointer Control

This command changes the display contents only at an arbitrary digit.

(The RAM write address is set.) The digit position to be modified is represented by the value of D3~D0. If the most significant digit(left-end digit) is to be selected, each of D3~D0 are set to a value of “1” and if the second digit is to be selected ,each of D3~D3 set to a value of “0”. Otherwise a decimal value of from “1”to “14” should be entered. The set value of D3~D0 is lower than the decimal value of the specified position by 2.

Table-10

Digit	Binary Code								Digit	Binary Code							
	D7	D6	D5	D4	D3	D2	D1	D0		D7	D6	D5	D4	D3	D2	D1	D0
Left End	1	0	1	0	1	1	1	1	9th	1	0	1	0	0	1	1	1
2nd	1	0	1	0	0	0	0	0	10th	1	0	1	0	1	0	0	0
3rd	1	0	1	0	0	0	0	1	11th	1	0	1	0	1	0	0	1
4th	1	0	1	0	0	0	1	0	12th	1	0	1	0	1	0	1	0
5th	1	0	1	0	0	0	1	1	13th	1	0	1	0	1	0	1	1
6th	1	0	1	0	0	1	0	0	14th	1	0	1	0	1	1	0	0
7th	1	0	1	0	0	1	0	1	15th	1	0	1	0	1	1	0	1
8th	1	0	1	0	0	1	1	0	Right End	1	0	1	0	1	1	1	0

### 5.1.2 Digit Counter Control

This command is used to define the number of display digits. The code is normally used only during initialization routine of the host system.

If all 16 characters are to be controlled, each of D3~D0 are set to a value of “0”, otherwise a decimal value from “1” to “15” is entered, corresponding to the actual number of characters to be controlled.

Table-11

Number of Display Digit	Binary Code								Number of Display Digit	Binary Code							
	D7	D6	D5	D4	D3	D2	D1	D0		D7	D6	D5	D4	D3	D2	D1	D0
1	1	1	0	0	0	0	0	1	9	1	1	0	0	1	0	0	1
2	1	1	0	0	0	0	1	0	10	1	1	0	0	1	0	1	0
3	1	1	0	0	0	0	1	1	11	1	1	0	0	1	0	1	1
4	1	1	0	0	0	1	0	0	12	1	1	0	0	1	1	0	0
5	1	1	0	0	0	1	0	1	13	1	1	0	0	1	1	0	1
6		1	0	0	0	1	1	0	14		1	0	0	1	1	1	0
7	1	1	0	0	0	1	1	1	15	1	1	0	0	1	1	1	1
8	1	1	0	0	1	0	0	0	16	1	1	0	0	0	0	0	0

### 5.1.3 Brightness Control

This command sets the brightness of the VFD. This command allows the brightness to be adjusted by 1/32 step. As shown in Table-12, the test value ranges from 0 to 31.

Table-12

Brightness Level	Binary Code								Brightness Level	Binary Code							
	D7	D6	D5	D4	D3	D2	D1	D0		D7	D6	D5	D4	D3	D2	D1	D0
0/31(0.0%)	1	1	1	0	0	0	0	0	16/31(51.6%)	1	1	1	1	0	0	0	0
1/31(3.2%)	1	1	1	0	0	0	0	1	17/31(54.8%)	1	1	1	1	0	0	0	1
2/31(6.4%)	1	1	1	0	0	0	1	0	18/31(58.1%)	1	1	1	1	0	0	1	0
3/31(9.7%)	1	1	1	0	0	0	1	1	19/31(61.2%)	1	1	1	1	0	0	1	1
4/31(12.9%)	1	1	1	0	0	1	0	0	20/31(64.5%)	1	1	1	1	0	1	0	0
5/31(16.1%)	1	1	1	0	0	1	0	1	21/31(67.7%)	1	1	1	1	0	1	0	1
6/31(19.4%)	1	1	1	0	0	1	1	0	22/31(71.0%)	1	1	1	1	0	1	1	0
7/31(22.6%)	1	1	1	0	0	1	1	1	23/31(74.2%)	1	1	1	1	0	1	1	1
8/31(25.8%)	1	1	1	0	1	0	0	0	24/31(77.4%)	1	1	1	1	1	0	0	0
9/31(29.0%)	1	1	1	0	1	0	0	1	25/31(80.6%)	1	1	1	1	1	0	0	1
10/31(32.3%)	1	1	1	0	1	0	1	0	26/31(83.9%)	1	1	1	1	1	0	1	0
11/31(35.5%)	1	1	1	0	1	0	1	1	27/31(87.1%)	1	1	1	1	1	0	1	1
12/31(38.7%)	1	1	1	0	1	1	0	0	28/31(90.3%)	1	1	1	1	1	1	0	0
13/31(41.9%)	1	1	1	0	1	1	0	1	29/31(93.5%)	1	1	1	1	1	1	0	1
14/31(45.2%)	1	1	1	0	1	1	1	0	30/31(96.8%)	1	1	1	1	1	1	1	0
15/31(48.4%)	1	1	1	0	1	1	1	1	31/31(100%)	1	1	1	1	1	1	1	1

### 5.2 Input Display Data Word

Display data words are loaded into the display buffer of module as 8-bit codes, with the MSB set to "0". The 64 available codes are shown in Table-14 on page 9/12. 16 display data words must be entered to fully load the display data buffer. The display buffer pointer (write in position) specified by the buffer. Pointer control command is automatically incremented by one each time the display data is entered.

To set the comma or decimal point, the display data codes of 2C Hex or 2E Hex is entered respectively. Only when 2C Hex and 2E Hex data are entered, the display buffer pointer in the RAM is not automatically incremented but stays present location.



5.3 RESET

The reset function allows the users to re-initialize the alphanumeric display controller, while the power is still applied to the module, by applying a logical “0” to pin #10(/RST) of the connector. (Pulse Width ≥ 100% )  
 When the controller is initialized, the display status are shown in Table-13. The RAM data (Display Buffer Data) are the same as the prior data.

Table-13

Parameter	Reset Status	Binary Code							
		D7	D6	D5	D4	D3	D2	D1	D0
Write in Position	Left End Digit	1	0	1	0	1	1	1	1
Number of Display Digit	16 Digits	1	1	0	0	0	0	0	0
Brightness Level	0%	1	1	1	0	0	0	0	0





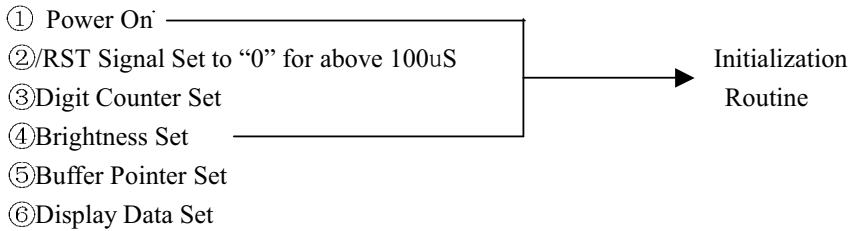



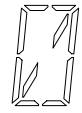
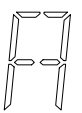
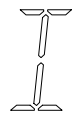
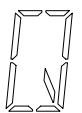
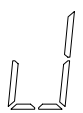

If automatic reset at time of power up is required, please contact NewHaven engineering prior to order placement.

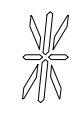
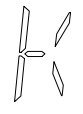
5.4 Data Set-up Flow

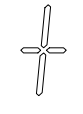
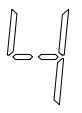
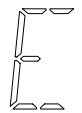
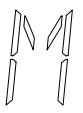
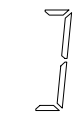

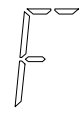
## Character Font Table

Table-14

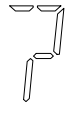
MSB LSB	0X000	0X001	0X010	0X011	0X100	0X101	0X110	0X111
000								
001								
010								
011								
100								
101								
110								
111								

STANDARD		DOCUMENT NO.	REV.NO	PAGE
		M0116LY-161LSA2	02	11 of 11

**6. OPERATING RECOMMENDATIONS**

- 6.1 Avoid applying excessive shock or vibration beyond the specification for the VFD module.
- 6.2 Since VFDs are made of glass material, careful handling is required.
- 6.3 When mounting the VFD module to your system, leave a slight gap between the VFD glass and your front panel.  
The module should be mounted without stress to avoid flexing of the PCB.
- 6.4 Avoid plugging or unplugging the interface connection with the power on, otherwise it may cause the severe damage to input circuitry.
- 6.5 Slow starting power supply may cause non-operation because one chip Micom won't be reset.
- 6.6 Exceeding any of maximum ratings may cause the permanent damage.
- 6.7 Since the VFD module contain high voltage source, careful handling is required while power is on.
- 6.8 When the power is turned off, the capacitor does not discharge immediately.  
So the high voltage applied to the VFD must not get in contact with ICs.  
In other word, short-circuit of mounted components on PCB within 30 seconds after power-off may cause damage the module.
- 6.9 The power supply must be capable of providing at least 3 time the rated current, because the surge current may be 3 times the specified current consumption when the power is turned on.
- 6.10 Avoid using the module where excessive noise interference is expected.  
Noise may affects the interface signal and causes improper operation. And it is important to keep the length of the interface cable less than 50cm.
- 6.11 Since all VFD modules contain C-MOS ICs, anti-static handling procedures are always required.