

NOTES:

1. ROHS COMPLIANT
2. HEADER: THERMOSET PLASTIC MATERIAL WITH FLAMMABILITY RATING UL 94V-0 OR BETTER.
3. STORAGE TEMPERATURE: -50°C TO +125°C
4. COMPLIANCE TO J-STD:
 - A. J-STD-002: SOLDERABILITY AT 245°C REFLOW PROFILE
 - B. J-STD-020: LEVEL 1, NO MOISTURE SENSITIVE
 - C. J-STD-075: R7, 245°C MAXIMUM THROUGH REFLOW SOLDER
5. TO ORDER TAPE & REEL PACKAGING ADD A "T" SUFFIX TO THE PART NUMBER(i.e HX1300NL BECOMES HX1300NLT).

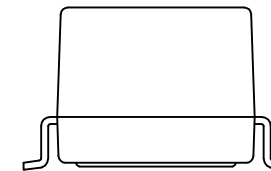
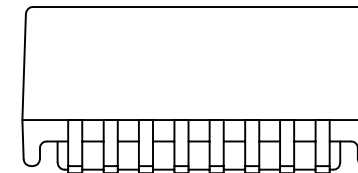
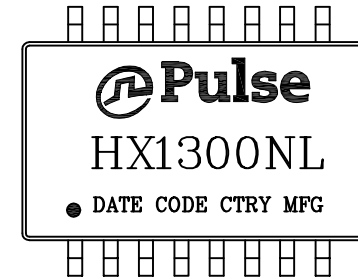

FINAL OUTLINE

© Copyright, 2015. Pulse Electronics Corp. All rights reserved. Pulse confidential & proprietary. (07/30/15)

PRODUCT DESCRIPTION	TLA DRAWING	PS DRAWING	SHEET	PART NO.	DATASHEET REV.
MDL,SIN,100D,1.414:1,SMT	HX1300NL-10	PS-2005.001-F	1 OF 3	HX1300NL	A

ELECTRICAL CHARACTERISTICS AT +25°C UNLESS OTHER SPECIFIED
MEETS IEEE 802.3 SPECIFICATION

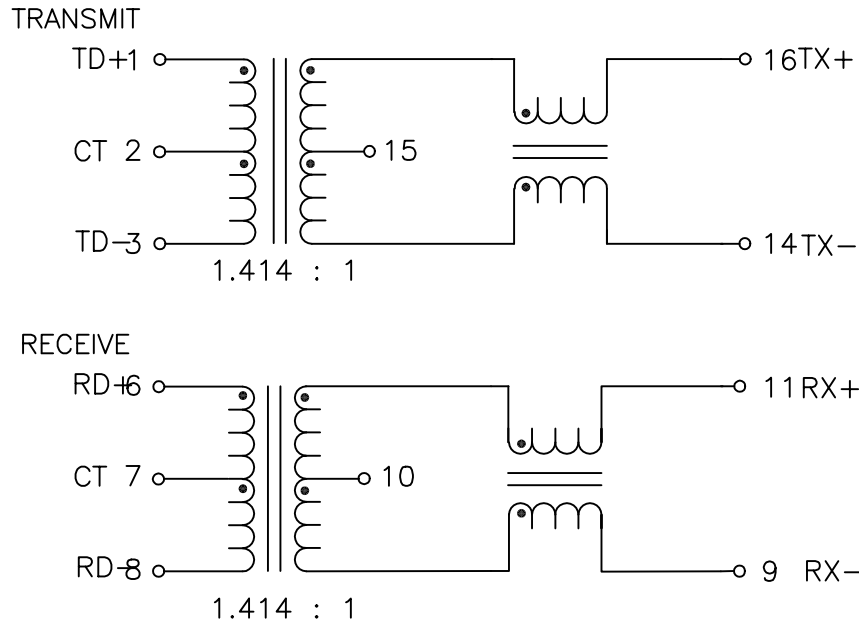

SCHEMATIC

PARAMETER	SPECIFICATIONS		
OPERATING TEMP	-40°C ~ +85°C		
POLARITY	PER SCHEMATIC		
INSERTION LOSS	100 KHz	1-125 MHz	
	-1.2 dB MAX	-0.2-0.002*f ^{1.4} dB MAX	
RETURN LOSS (Z OUT = 100 OHM ±15%)	.1-30 MHz	30-60 MHz	60-80 MHz
	-16 dB MIN	-10+20*LOG ₁₀ (f/60 MHz) dB MIN	-10 dB MIN
INDUCTANCE (OCL) (MEDIA SIDE, -40°C~85°C)	350 uH MIN (MEASURED AT 100 KHz, 100 mVRMS) WITH 8 mA DC BIAS		
	325 uH MIN AT -40°C		
CROSSTALK, ADJACENT CHANNELS	1 MHz	10-100 MHz	
	-50 dB MIN	-55+22*LOG ₁₀ (f/10) dB MIN	
COMMON MODE REJECTION RATIO	2 MHz	30-200 MHz	
	-50 dB MIN	-15+20*LOG ₁₀ (f/200) dB MIN	
DC RESISTANCE, 1/2 WINDING	.65 OHMS MAX		
DC RESISTANCE IMBALANCE	±.065 OHMS MAX (CENTER TAP SYMMETRY)		
INPUT - OUTPUT ISOLATION	1500 VRMS MIN @ 60 SECONDS		

NOTE: f IS FREQUENCY IN MHz.

© Copyright, 2015. Pulse Electronics Corp. All rights reserved. Pulse confidential & proprietary. (07/30/15)

PRODUCT DESCRIPTION	TLA DRAWING	PS DRAWING	SHEET	PART NO.	DATASHEET REV.
MDL,SIN,100D,1.414:1,SMT	HX1300NL-10	PS-2005.001-F	2 OF 3	HX1300NL	A

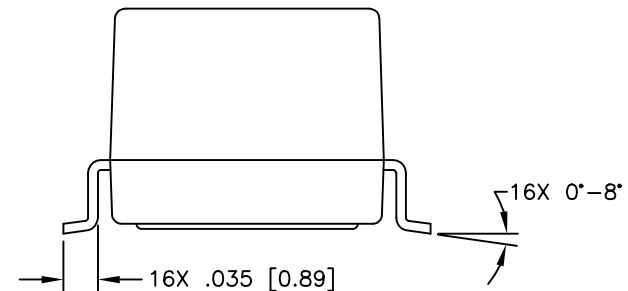
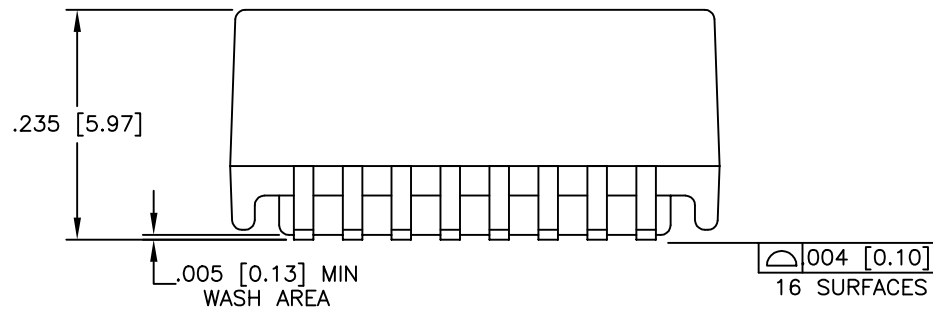
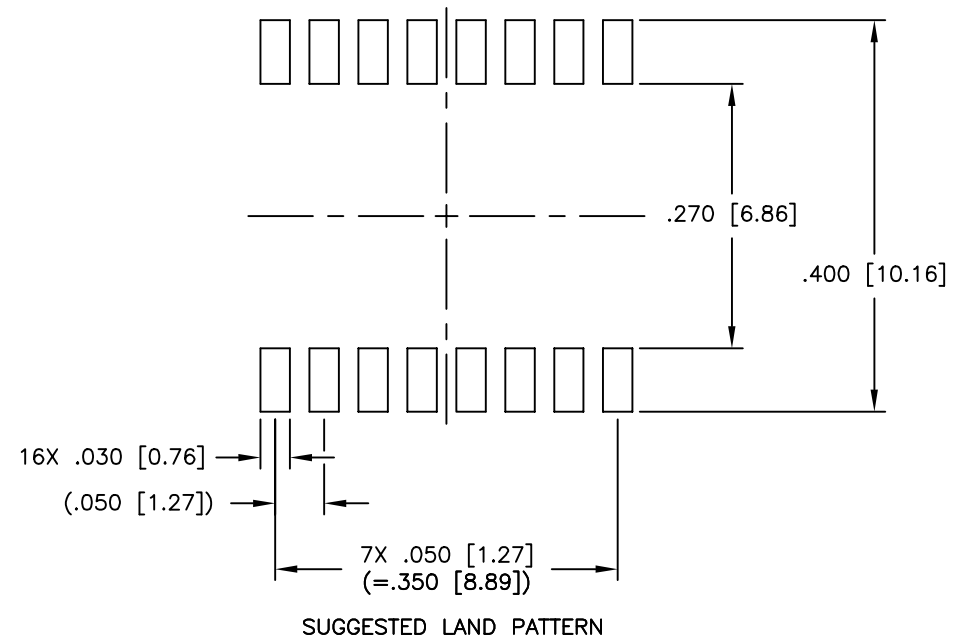
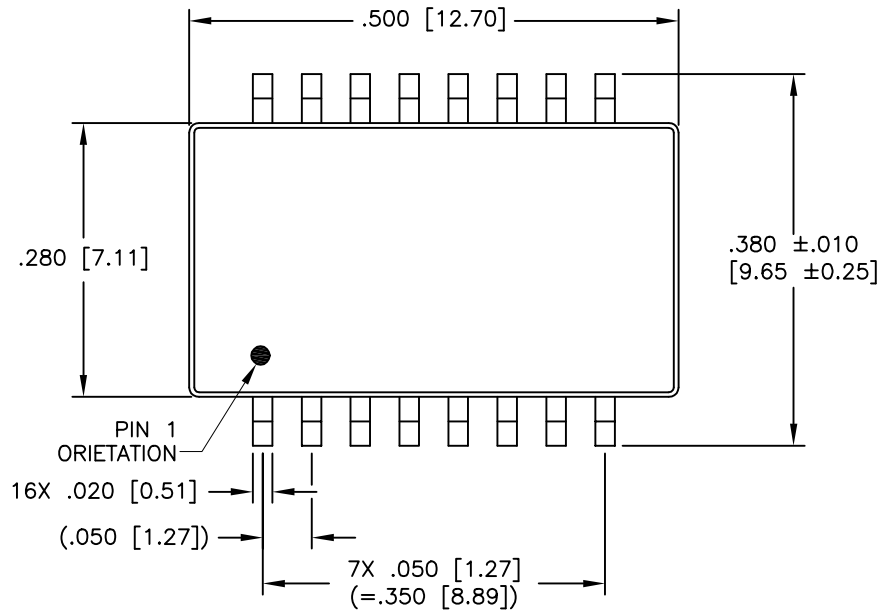

DIMENSIONS ARE IN INCHES [MILLIMETERS] WITH THE FOLLOWING TOLERANCES: [MILLIMETERS] ARE FOR REFERENCE ONLY.
 .XX= ±.01 [±0.25]
 .XXX= ±.005 [±0.13]

© Copyright, 2015. Pulse Electronics Corp. All rights reserved. Pulse confidential & proprietary. (07/30/15)

PRODUCT DESCRIPTION	TLA DRAWING	PS DRAWING	SHEET	PART NO.	DATASHEET REV.
MDL,SIN,100D,1.414:1,SMT	HX1300NL-10	PS-2005.001-F	3 OF 3	HX1300NL	A