

Part Number: WP138A8QMP/GD/TG Green

Features

- Surface mount type.
- Black case enhances contrast ratio.
- Wide viewing angle.
- High reliability life measured in years.
- Package: 1000pcs / reel.
- Moisture sensitivity level : level 3.
- Housing UL rating: 94V-0.
- Housing material: PPA.
- High temperature resistant housing.
- High glass transition temperature epoxy.
- RoHS compliant.

Description

The Green source color devices are made with Gallium Phosphide Green Light Emitting Diode.

Package Dimensions

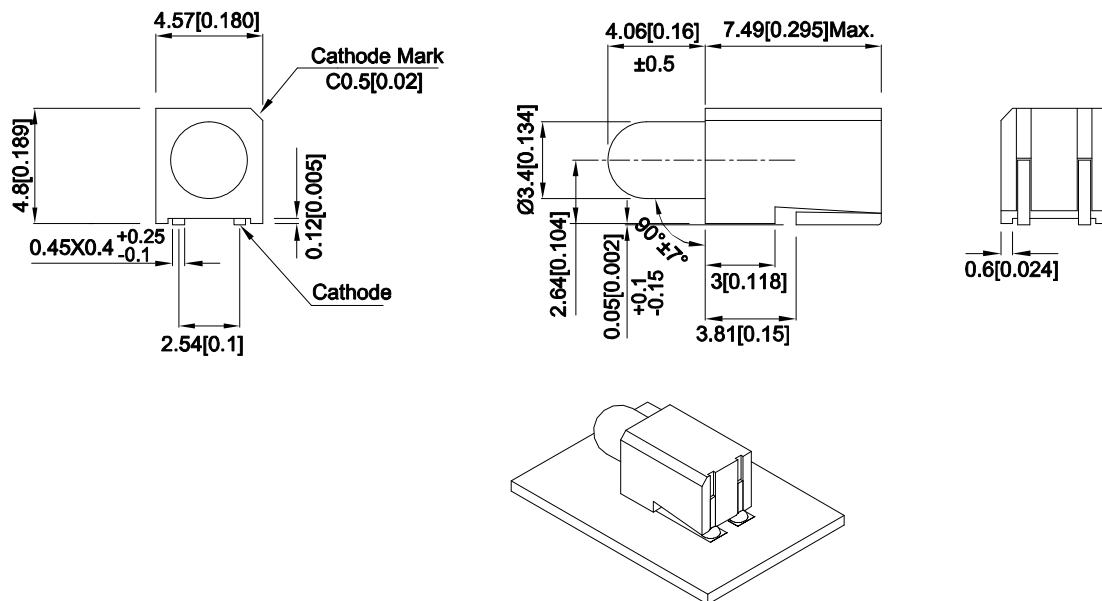

Notes:

1. All dimensions are in millimeters (inches).
2. Tolerance is ± 0.25 (0.01") unless otherwise noted.
3. The specifications, characteristics and technical data described in the datasheet are subject to change without prior notice.



Selection Guide

Part No.	Emitting Color (Material)	Lens Type	Iv (mcd) [2] @ 10mA		Viewing Angle [1]
			Min.	Typ.	2θ1/2
WP138A8QMP/GD/TG	Green (GaP)	Green Diffused	6	12	40°

Notes:

1. θ1/2 is the angle from optical centerline where the luminous intensity is 1/2 of the optical peak value.
2. Luminous intensity/ luminous Flux: +/-15%.
3. Luminous intensity value is traceable to CIE127-2007 standards.

Electrical / Optical Characteristics at TA=25°C

Symbol	Parameter	Emitting Color	Typ.	Max.	Units	Test Conditions
λ _{peak}	Peak Wavelength	Green	565		nm	I _F =10mA
λ _D [1]	Dominant Wavelength	Green	568		nm	I _F =10mA
Δλ _{1/2}	Spectral Line Half-width	Green	30		nm	I _F =10mA
C	Capacitance	Green	15		pF	V _F =0V;f=1MHz
V _F [2]	Forward Voltage	Green	2.0	2.5	V	I _F =10mA
I _R	Reverse Current	Green		10	uA	V _R = 5V

Notes:

1. Wavelength: +/-1nm.
2. Forward Voltage: +/-0.1V.
3. Wavelength value is traceable to CIE127-2007 standards.
4. Excess driving current and/or operating temperature higher than recommended conditions may result in severe light degradation or premature failure.

Absolute Maximum Ratings at TA=25°C

Parameter	Values	Units
Power dissipation	62.5	mW
DC Forward Current	25	mA
Peak Forward Current [1]	140	mA
Reverse Voltage	5	V
Operating Temperature	-40°C To +85°C	
Storage Temperature	-40°C To +85°C	

Notes:

1. 1/10 Duty Cycle, 0.1ms Pulse Width.
2. Relative humidity levels maintained between 40% and 60% in production area are recommended to avoid the build-up of static electricity – Ref JEDEC/JESD625-A and JEDEC/J-STD-033.

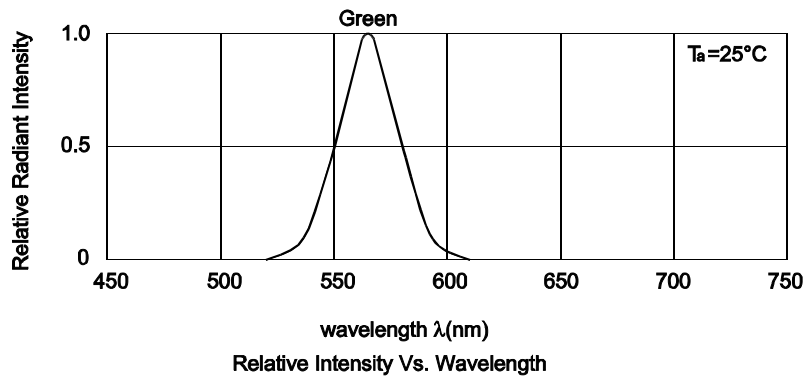

Green

WP138A8QMP/GD/TG

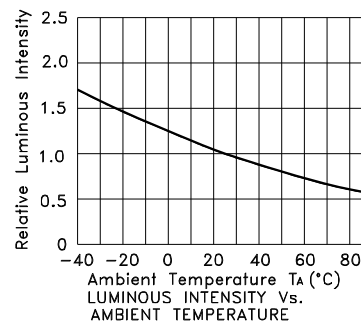
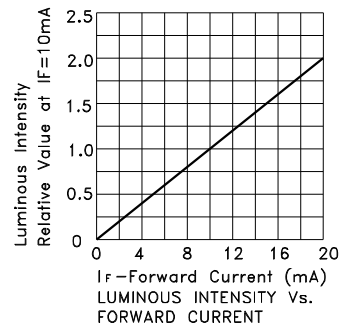

WP138A8QMP/GD/TG

Recommended Soldering Pattern
(Units : mm; Tolerance: ± 0.1)

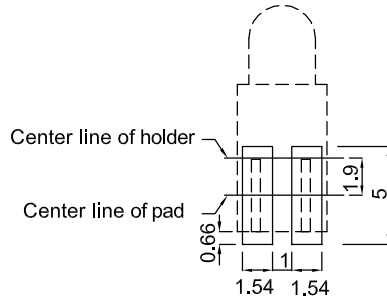

Reel Dimension

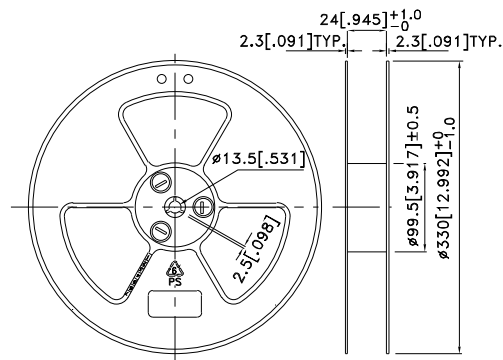

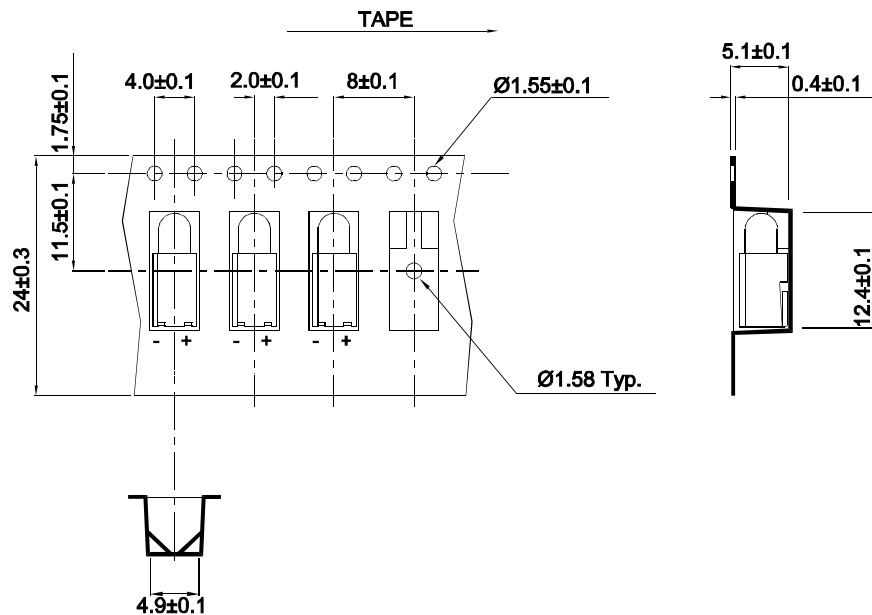

Tape Dimensions (Units : mm)

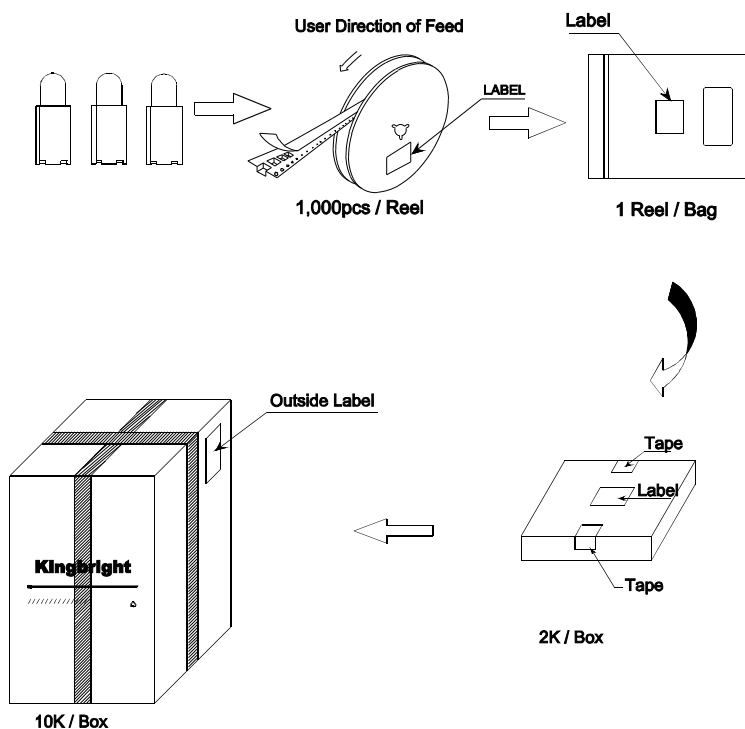

PACKING & LABEL SPECIFICATIONS

WP138A8QMP/GD/TG



Kingbright	
P/NO: WP138A8QMPxxx	
QTY: 1,000 pcs	Q.C. Q C XXXXXX PASSED
S/N: XXXX	
CODE: XXX	
LOT NO:	
 <small>XXXXXXXXXXXXXXXXXXXXXXXXXXXX</small>	
RoHS Compliant	

Terms and conditions for the usage of this document

1. The information included in this document reflects representative usage scenarios and is intended for technical reference only.
2. The part number, type, and specifications mentioned in this document are subject to future change and improvement without notice. Before production usage customer should refer to the latest datasheet for the updated specifications.
3. When using the products referenced in this document, please make sure the product is being operated within the environmental and electrical limits specified in the datasheet. If customer usage exceeds the specified limits, Kingbright will not be responsible for any subsequent issues.
4. The information in this document applies to typical usage in consumer electronics applications. If customer's application has special reliability requirements or have life-threatening liabilities, such as automotive or medical usage, please consult with Kingbright representative for further assistance.
5. The contents and information of this document may not be reproduced or re-transmitted without permission by Kingbright.
6. All design applications should refer to Kingbright application notes available at <http://www.KingbrightUSA.com/ApplicationNotes>

PRECAUTIONS

1. A moisture barrier bag (MBB) containing LEDs shall be kept in an environment with temperature below 40°C and humidity below 90% RH.
A MBB shall be kept sealed until the LEDs contained in that bag are to be used immediately.
Storage in an environment with temperature 5~30°C and humidity below 60% RH.
2. After a MBB has been opened, all LEDs contained in that bag shall complete soldering process within according to the conditions listed on the Kingbright MBB.
3. If the 10% spot of a humidity indicator card (HIC) indicates wet, LEDs shall be baked according to the conditions listed on the Kingbright MBB.
4. During soldering, component covers and holders should leave clearance to avoid placing damaging stress on the LED during soldering.



5. The tip of the soldering iron should never touch the lens epoxy.
6. After soldering, allow at least three minutes for the component to cool down to room temperature before further operations.
7. If the LED will undergo multiple soldering passes or face other processes where the part may be subjected to intense heat, please check with Kingbright for compatibility.
8. Recommended Reflow Soldering Profiles For SMD Housing LEDs

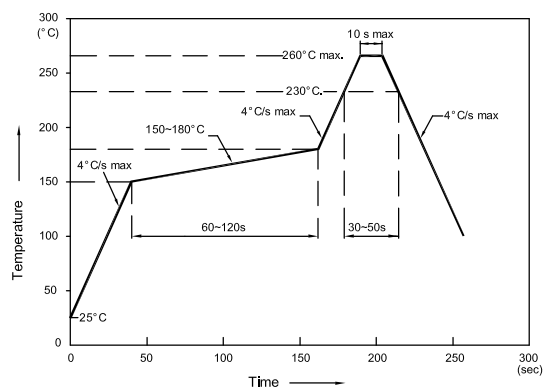

NOTES:

1. We recommend the reflow temperature 245°C(±5°C). The maximum soldering temperature should be limited to 260°C.
2. Don't cause stress to the epoxy resin while it is exposed to high temperature.
3. Recommended Solder: Sn/Cu/Ag.
4. No more than once.