

Title	<i>Reference Design Report for a 12.6 W, TRIAC Dimmable, High Efficiency (>86%) Isolated Flyback, Power Factor Corrected (>0.97) LED Driver Using LYTSwitch™ LYT4313E</i>
Specification	90 VAC – 132 VAC Input; 34 V, 370 mA Output
Application	Down Light LED Driver
Author	Applications Engineering Department
Document Number	RDR-347
Date	February 11, 2013
Revision	1.2

Summary and Features

- High efficiency, $\geq 86\%$ at 120 VAC
- Low cost
 - Single-stage converter
 - Single sided PCB
 - Low component count
- Works with a wide range of leading edge and trailing edge TRIAC dimmers
 - Wide dimming range
 - No pop-on, reduced dead band and very fast start-up
- Enhanced user experience
 - Flicker-free, fast monotonic start-up (<250 ms) – no perceptible delay
 - Thermal fold back prevents shut off in high output temperatures
- Integrated protection and reliability features
 - Output open circuit / output short-circuit protected with auto-recovery
 - Line input overvoltage shutdown extends voltage withstand during line faults
 - Auto-recovering thermal shutdown with large hysteresis protects both components and printed circuit board
- IEC 61000-4-5 ring wave, IEC 61000-3-2 C combination and EN55015 B conducted EMI compliant

PATENT INFORMATION

The products and applications illustrated herein (including transformer construction and circuits external to the products) may be covered by one or more U.S. and foreign patents, or potentially by pending U.S. and foreign patent applications assigned to Power Integrations. A complete list of Power Integrations' patents may be found at www.powerint.com. Power Integrations grants its customers a license under certain patent rights as set forth at <http://www.powerint.com/ip.htm>.



Table of Contents

1	Introduction	6
2	Power Supply Specification	9
3	Schematic	10
3.1	Typical Schematic.....	10
3.2	Active Pre-load Option.....	10
4	Circuit Description.....	11
4.1	Input Filtering.....	11
4.2	LYTSwitch Primary	11
4.3	Feedback.....	12
4.4	Temperature Fold Back Circuit	12
4.5	Output Rectification	13
4.6	Disconnected and Shorted Load Protection	13
4.7	TRIAC Phase Dimming Control Compatibility.....	13
4.7.1	Active Pre-Load Circuit.....	14
5	PCB Layout.....	15
6	Bill of Materials	17
7	Transformer Specification	19
7.1	Electrical Diagram.....	19
7.2	Electrical Specifications	19
7.3	Materials	19
7.4	Transformer Build Diagram.....	20
7.5	Transformer Construction	20
8	U1 Heat Sink Assembly	21
8.1	U1 Heat Sink Fabrication Drawing.....	21
8.2	U1 Heat Sink Assembly Drawing.....	22
8.3	U1 and Heat Sink Assembly Drawing.....	23
9	Performance Data.....	24
9.1	Efficiency	24
9.2	Line and Load Regulation.....	26
9.3	Power Factor	27
9.4	A-THD.....	28
9.5	Harmonic Currents.....	29
9.5.1	30 V LED Load	29
9.5.3	34 V LED Load	30
9.5.4	38 V LED Load	31
9.6	Test Data	32
9.6.1	Test Data, 30 V LED Load.....	32
9.6.2	Test Data, 34 V LED Load.....	32
9.6.3	Test Data, 38 V LED Load.....	32
9.6.4	120 VAC 60 Hz, 30 V LED Load Harmonics Data	33
9.6.5	120 VAC 60 Hz, 34 V LED Load Harmonics Data	34
9.6.6	120 VAC 60 Hz, 38 V LED Load Harmonics Data	35
10	Dimming Performance Data.....	36
10.1	Dimming Curve with Simulated TRIAC	36



10.2	Dimmer Compatibility List.....	37
11	Thermal Performance.....	38
11.1	Non-Dimming $V_{IN} = 90$ VAC, 60 Hz, 34 V LED Load.....	38
11.2	Non-Dimming $V_{IN} = 132$ VAC, 60 Hz, 34 V LED Load.....	38
11.3	Dimming $V_{IN} = 120$ VAC, 60 Hz, 90° Conduction Angle, 34 V LED Load.....	39
12	Non-Dimming Waveforms.....	40
12.1	Input Voltage and Input Current Waveforms.....	40
12.2	Output Current and Output Voltage at Normal Operation.....	41
12.2.1	990 μ F Output Capacitance.....	41
12.2.2	220 μ F Output Capacitance.....	42
12.3	Input Voltage and Output Current Waveform at Start-Up.....	43
12.4	Drain Voltage and Current at Normal Operation.....	44
12.5	Drain Voltage and Current at Start-Up.....	45
12.6	Drain Voltage and Current at Output Short Condition.....	46
12.7	Output Diode Voltage and Current at Normal Operation.....	47
12.8	Output Diode Voltage and Current at Start-up and Output Short Condition.....	48
12.9	Output Voltage during Open Load Condition.....	48
13	Dimming Waveforms.....	49
13.1	Input Voltage and Input Current Waveforms.....	49
13.2	Output Current Waveforms.....	50
13.3	Input Voltage and Output Current Waveform at 10% and 1% I_{OUT} Start-Up.....	51
14	Conducted EMI.....	52
14.1	Test Set-Up.....	52
14.2	Test Result.....	53
15	Line Surge.....	54
16	No Active Pre-Load Option.....	55
16.1	Schematic.....	55
16.2	Bill of Materials.....	56
16.3	Efficiency.....	57
16.4	Line and Load Regulation.....	58
16.5	Power Factor.....	59
16.6	A-THD.....	60
16.7	Harmonic Currents.....	61
16.7.1	30 V LED Load.....	61
16.7.3	34 V LED Load.....	62
16.7.4	38 V LED Load.....	63
16.8	Test Data.....	64
16.8.1	Test Data, 30 V LED Load.....	64
16.8.2	Test Data, 34 V LED Load.....	64
16.8.3	Test Data, 38 V LED Load.....	64
16.8.4	120 VAC 60 Hz, 30 V LED Load Harmonics Data.....	65
16.8.5	120 VAC 60 Hz, 34 V LED Load Harmonics Data.....	66
16.8.7	120 VAC 60 Hz, 38 V LED Load Harmonics Data.....	67
16.9	Dimming Curve with Simulated TRIAC.....	68
16.10	Dimmer Compatibility List.....	69



- 17 Alternate EMI Configuration for Leading Edge TRIAC Dimming with Reduced Audible Noise70
 - 17.1 Schematic70
 - 17.2 Bill of Materials71
 - 17.3 Efficiency, PF, THD Data73
 - 17.4 Dimming Data74
 - 17.4.1 Leading Edge Dimmer Test Data74
 - 17.4.2 Trailing Edge Dimmer Test Data74
 - 17.4.3 Dimming Curve75
 - 17.5 Conducted EMI76
- 18 Revision History77

Important Note: Although this board is designed to satisfy safety isolation requirements, the engineering prototype has not been agency approved. Therefore, all testing should be performed using an isolation transformer to provide the AC input to the prototype board.



1 Introduction

The document describes an isolated high power factor (PF) TRIAC dimmable LED driver designed to drive an LED string voltage of 34 V at 370 mA from an input voltage range of 90 VAC to 132 VAC. The LED driver utilizes the LYT4313E from the LYTSwitch family of ICs.

The topology used is a single-stage power factor corrected flyback that delivers high efficiency, high power factor, low THD, isolation, low component count, and dimming performance required for this design.

High power factor and low THD is achieved by employing the LYTSwitch IC which also provides a sophisticated range of protection features including auto-restart for open control loop and output short-circuit conditions. Line overvoltage provides extended line fault and surge withstand, and accurate hysteretic thermal shutdown that ensures safe average PCB temperatures under all conditions.

This document contains the LED driver specification, schematic, PCB diagram, bill of materials, transformer documentation and typical performance characteristics.

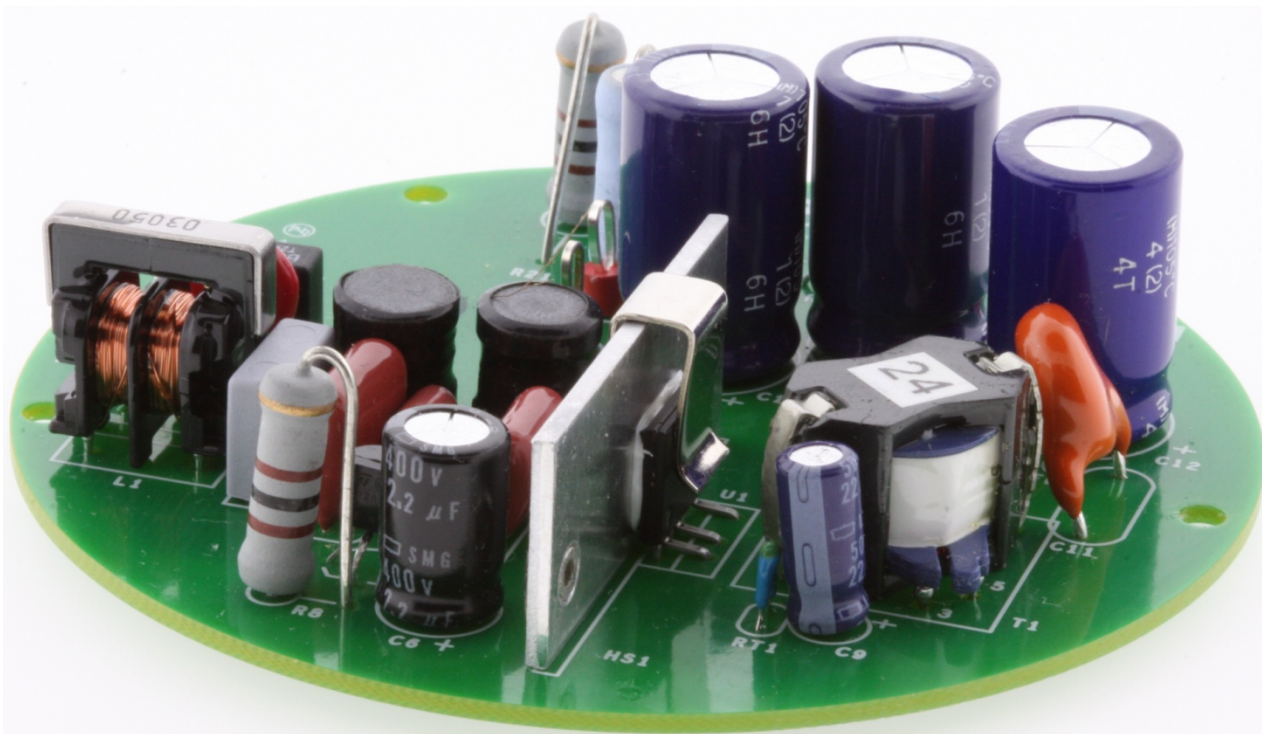

Figure 1 – Populated Circuit Board Photograph.



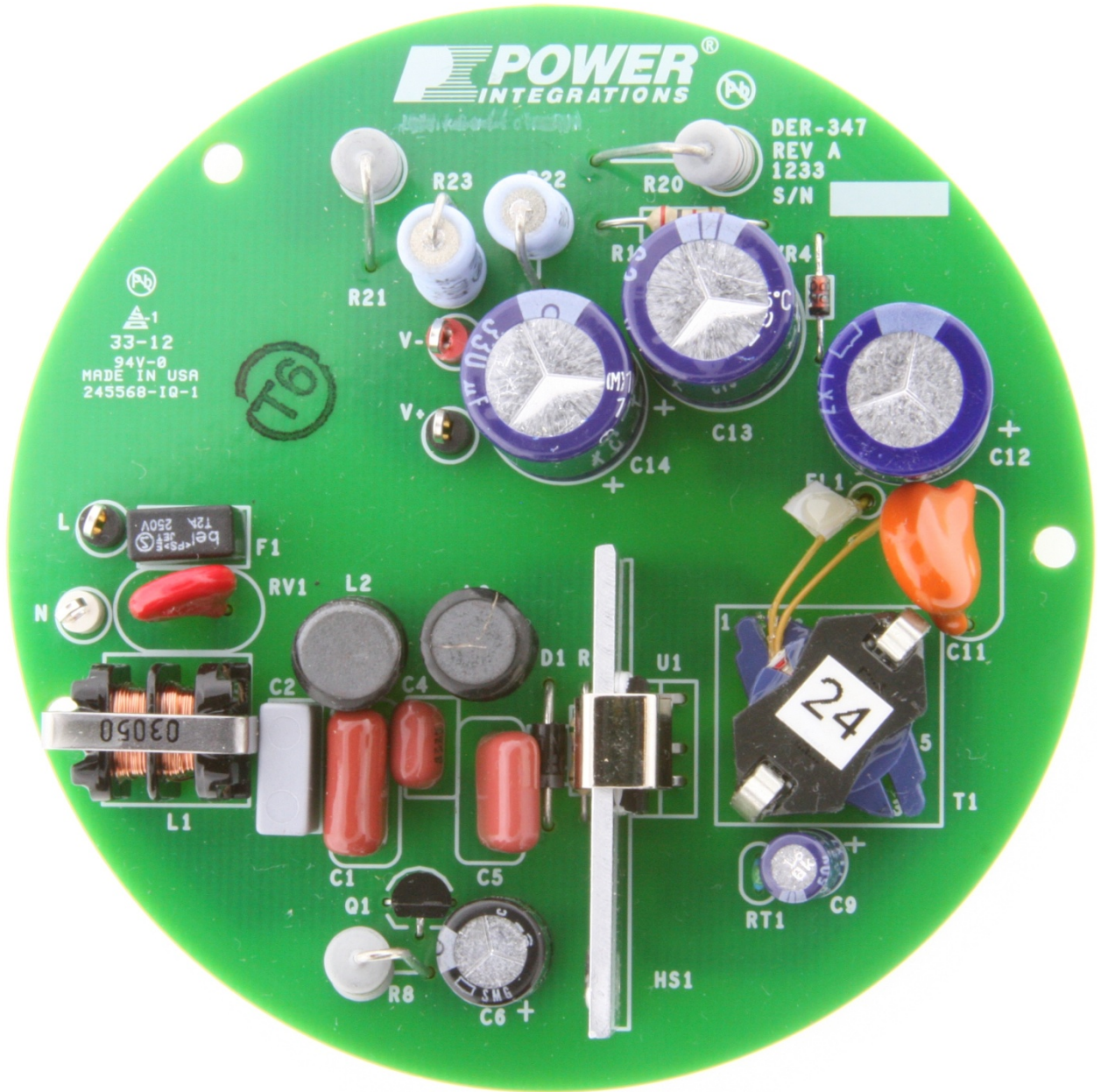

Figure 2 – Populated Circuit Board Photograph (Top View).



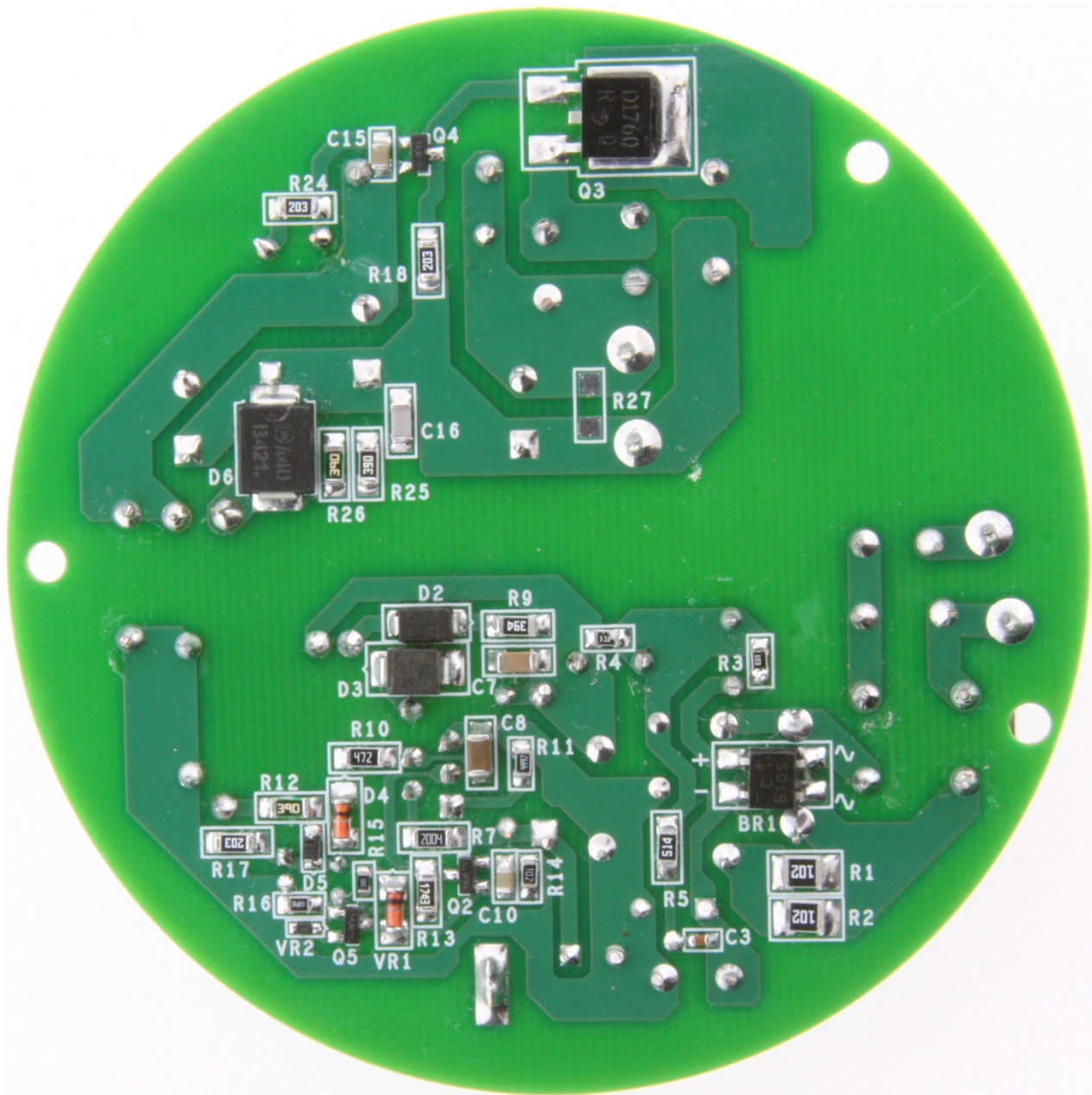

Figure 3 – Populated Circuit Board Photograph (Bottom View).



2 Power Supply Specification

The table below represents the minimum acceptable performance of the design. Actual performance is listed in the results section.

Description	Symbol	Min	Typ	Max	Units	Comment
Input Voltage	V_{IN}	90	120	132	VAC	
Frequency	f_{LINE}		60		Hz	
Output Output Voltage	V_{OUT}		34		V	$V_{OUT} = 34, V_{IN} = 120 \text{ VAC}, 25 \text{ }^\circ\text{C};$ $\pm 5\%$
Output Current	I_{OUT}	352	370	388	mA	
Total Output Power Continuous Output Power	P_{OUT}		12.6		W	
Efficiency Full Load	η		86		%	Measured at P_{OUT} 25 °C at 120VAC nominal LED load (34V)
Environmental Conducted EMI		CISPR 15B / EN55015B				
Safety		Isolated				
Ring Wave (100 kHz) Differential Mode (L1-L2) Common mode (L1/L2-PE)			2.5		kV	
Differential Surge (1.2/50 μs)			500		V	
Power Factor			0.97			Measured at $V_{OUT(TYP)}, I_{OUT(TYP)}$ and 120 VAC, 60 Hz
Harmonic Currents		EN 61000-3-2 Class D (C)				Class C specifies Class D Limits when $P_{IN} < 25 \text{ W}$
Ambient Temperature	T_{AMB}		50		$^\circ\text{C}$	Free convection, sea level



3 Schematic

3.1 Typical Schematic

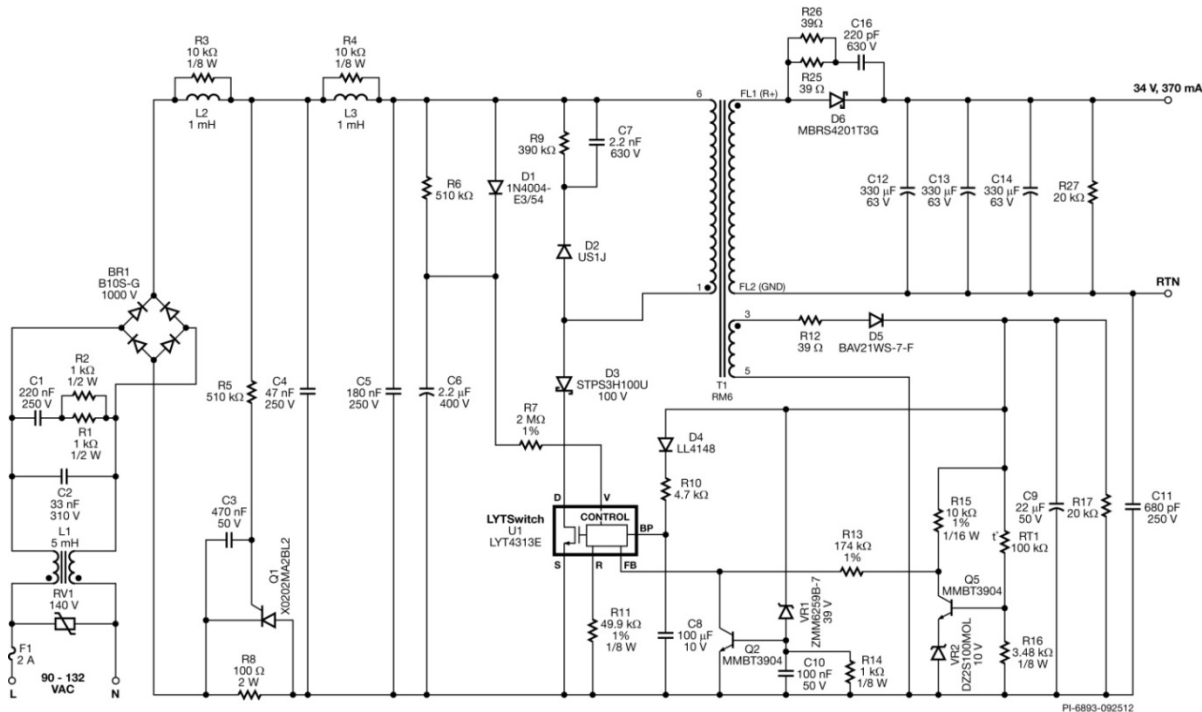

Figure 4 – Typical Schematic with Thermal Fold Back (Full performance report in Section 16)

3.2 Active Pre-load Option

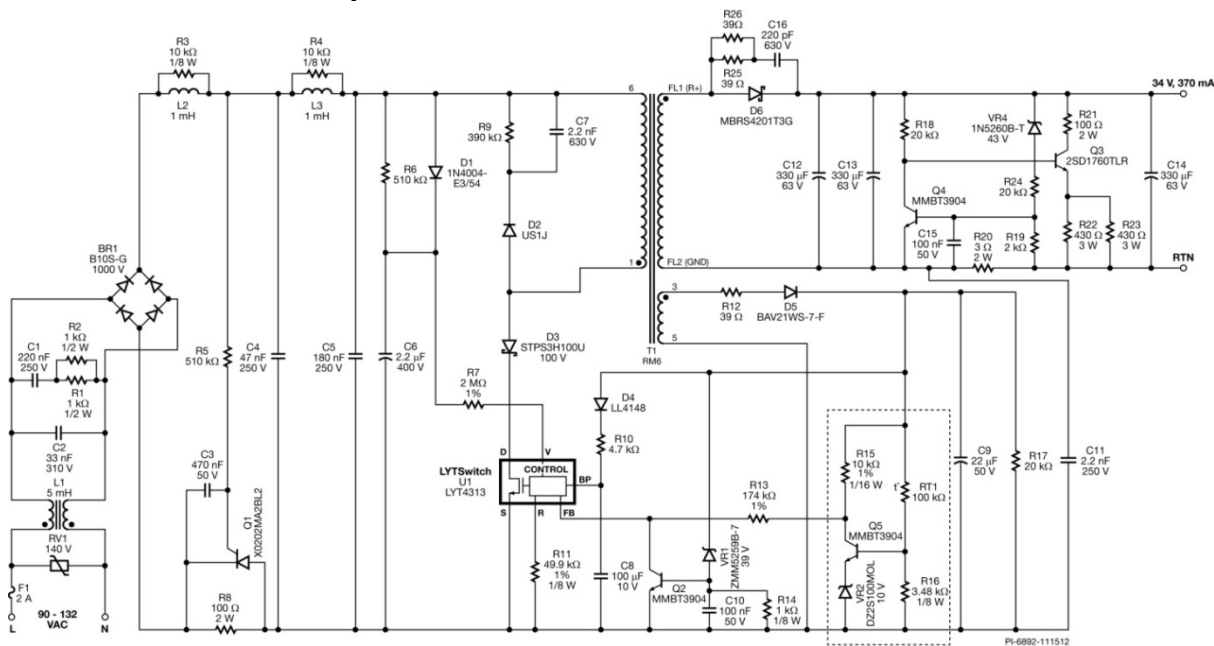

Figure 5 – Schematic with Optional Active Pre-load (Improved Dimming) and Thermal Fold Back Highlighted



4 Circuit Description

The LYTSwitch device is a controller with an integrated 650 V power MOSFET for use in LED driver applications. The LYTSwitch is configured for use in a single-stage flyback topology which provides a primary side regulated, constant current output while maintaining high power factor.

4.1 Input Filtering

Fuse F1 provides protection from component failure. A relatively high current rating was selected to prevent failure during differential (1.2 μ s / 50 μ s) line surge. Varistor RV1 provides a clamp to limit the maximum voltage during differential line surges. A 140 VAC rated part was selected, being slightly above the maximum specified operating voltage of 132 VAC. Diode bridge BR1 rectifies the AC line voltage with capacitor C5 providing a low impedance path (decoupling) for the primary switching current.

EMI filtering is provided by inductors L1, L2, and L3, and capacitors C2, C4, and C5. Resistor R3 and R4 positioned across L2 and L3 damp any LC resonances due to the filter components and the AC line impedance which would otherwise cause increased conducted EMI.

4.2 LYTSwitch Primary

One side of the transformer (T1) is connected to the DC bus and the other to the DRAIN (D) pin of the LYTSwitch via blocking diode D3. During the on-time of the power MOSFET, current ramps through the primary, storing energy which is then delivered to the output during the power MOSFET off-time. An RM6S/I core size was selected to meet the power processing requirements of the design.

To provide peak line voltage information to U1 the incoming rectified AC voltage peak charges C6 via D1. This is then fed into the VOLTAGE MONITOR (V) pin of U1 as a current via R7. Resistor R6 provides a discharge path for C6 with a time constant much longer than that of the rectified AC to prevent the V pin current being modulated at the line frequency (which would degrade power factor).

The line overvoltage shutdown function extends the rectified line voltage withstand (during surges and line swells) to the 650 BV_{DSS} rating of the internal power MOSFET.

The V pin current and the FEEDBACK (FB) pin current are used internally to control the average output LED current. For phase angle dimming applications a 49.9 k Ω resistor is used on the REFERENCE (R) pin (R11) and 2 M Ω (R7) on the V pin to provide a linear relationship between input voltage and the output current. This maximizes the dimming range when used with TRIAC dimmers.

During the power MOSFET off-time, D2, R9, and C7 clamp the drain voltage to a safe level due to the effects of leakage inductance. Diode D3 is necessary to prevent reverse current from flowing through U1 while the voltage across C5 (rectified input AC) falls to



below the reflected output voltage (parameter V_{OR} in the design spreadsheet). For lower cost an ultrafast type may be selected (US1B) with a slight (0.3%) reduction in efficiency.

Diode D5, C9, R12 and R17 generate a primary bias supply from an auxiliary winding on the transformer. Resistor R12 provides filtering so that the bias voltage tracks the output voltage closely and maintains a constant output current with changes in LED voltage. Resistor R17 prevents C9 peak charging during output short circuit condition, ensuring the driver safely enters auto-restart.

Capacitor C8 provides local decoupling for the BYPASS (BP) pin of U1 which is the supply pin for the internal controller. During start-up, C8 is charged to ~6 V from an internal high-voltage current source connected to the D pin. Once charged U1 starts switching at which point the operating supply current is provided from the bias supply via R10.

The use of an external bias supply (via D4 and R10) is recommended to give the lowest device dissipation and provide sufficient supply to U1 during deep dimming conditions.

Capacitor C8 also selects the output power mode, 100 μ F was selected (reduced power mode) to minimize the device dissipation and minimize heat sinking requirements.

4.3 Feedback

The bias winding voltage is used to sense the output voltage indirectly, eliminating secondary side feedback components. The voltage on the bias winding is proportional to the output voltage (set by the turn ratio between the bias and secondary windings). Resistors R13 and R15 converts the bias voltage into a current which is fed into the FB pin of U1. The internal engine within U1 combines the FB pin current, the V pin current, and internal drain current information to provide a constant output current whilst maintaining high input power factor.

4.4 Temperature Fold Back Circuit

The board also includes an optional temperature fold back circuit. This reduces the output power linearly as the driver temperature increases beyond a set value. This feature effectively extends the maximum operating ambient temperature of a given LYTSwitch LED driver while protecting the driver components and LED array from excess temperature.

Zener diode VR2 and the voltage across the node of resistor R16 and thermistor (NTC) RT1 dictate the start of temperature fold back. As the monitored temperature rises, so does the base voltage of Q5. Once this exceeds the voltage of VR2 plus a V_{BE} drop, Q5 is biased on. Further increases in temperature will start diverting current from the FB pin, which will cause a reduction in output current / power.

Resistor R16 can be adjusted to vary the temperature trip point at which output power reduction starts desired.



4.5 Output Rectification

The transformer secondary winding is rectified by D6 and filtered by capacitors C12, C13, and C14.

For designs where higher ripple is acceptable and lower cost, the output capacitance value can be reduced.

4.6 Disconnected and Shorted Load Protection

The part enters auto-restart whenever the FB current falls below the $I_{FB(AR)}$ threshold for longer than the ~ 76 ms.

In case of open (disconnected) load fault, Zener diode VR1 will conduct turning on transistor Q2. Transistor Q2 then pulls down the FB pin to force the IC into auto-restart mode.

During an output short circuit the output voltage and therefore bias voltage collapses. This causes the current into the FB pin to drop below $I_{FB(AR)}$.

Once in auto-restart dissipation is limited to $\sim 25\%$ of the rated output power, providing a safe condition. Once either fault is removed the driver returns to normal operation at the completion of the current auto-restart cycle off period (~ 225 ms).

4.7 TRIAC Phase Dimming Control Compatibility

The requirement to provide output dimming with low cost, TRIAC based, leading edge phase dimmers introduced a number of tradeoffs in the design.

Due to the much lower power consumed by LED based lighting the current drawn by the lamp can fall below the holding current of the TRIAC within the dimmer. This causes undesirable behavior such as the lamp turning off before the end of the dimmer control range and/or flickering as the TRIAC fires inconsistently. The relatively large impedance the LED lamp presents to the line allows significant ringing to occur due to the inrush current charging the input capacitance when the TRIAC turns on. This too can cause similar undesirable behavior as the ringing may cause the TRIAC current to fall to zero.

To overcome these issues, active damper and passive bleeder circuits were added. The drawback of these circuits is increased dissipation and therefore reduced efficiency of the supply. For non-dimming applications these components can simply be omitted.

The active damper consists of components R5, Q1, C3 and R8. This circuit limits the inrush current that flows to charge C4 and C5 when the TRIAC turns on by placing R8 in series for the first 1 ms of the conduction period. After approximately 1 ms, Q1 turns on and shorts R8. This keeps the power dissipation on R8 low and allows a larger value to be used for more effective during current limiting. Resistor R5 and C3 provide the 1 ms delay after the TRIAC conducts. The SCR selected for Q1 is a low current, low cost



device in a TO-92 package. Resistor R28 (typical value 10 – 22 Ω) in series with R8 is optional placement for additional damping for Triac rated > 1000W.

The passive bleeder circuit is comprised of C1 and parallel combination of R1, and R2. The bleeder keeps the input current above the TRIAC holding current while the driver input current increases during each AC half-cycle, preventing the TRIAC switch from oscillating at the start (and end) of each conduction angle period.

4.7.1 Active Pre-Load Circuit

The active pre-load circuit is added to extend dimming range capability and provide additional loading during TRIAC dimming.

Resistor R20 senses the output current. If the output current falls below ~200 mA, transistor Q4 turns-off and transistor Q3 turns-on decreasing the output current flowing into the LED. This arrangement provides minimum output current of <0.1 mA at a conduction angle of ~50°. At an output current of >200 mA, the active pre-load circuit disengages, minimizing the reduction in efficiency. Resistors R21, R22, and R23 sets the maximum current flowing into the pre-load circuit and can be used to control the dimming curve. VR4 and R24 are also employed to disable the active pre-load during open load condition. The temperature rise of R22 and R23 can be significant.



5 PCB Layout

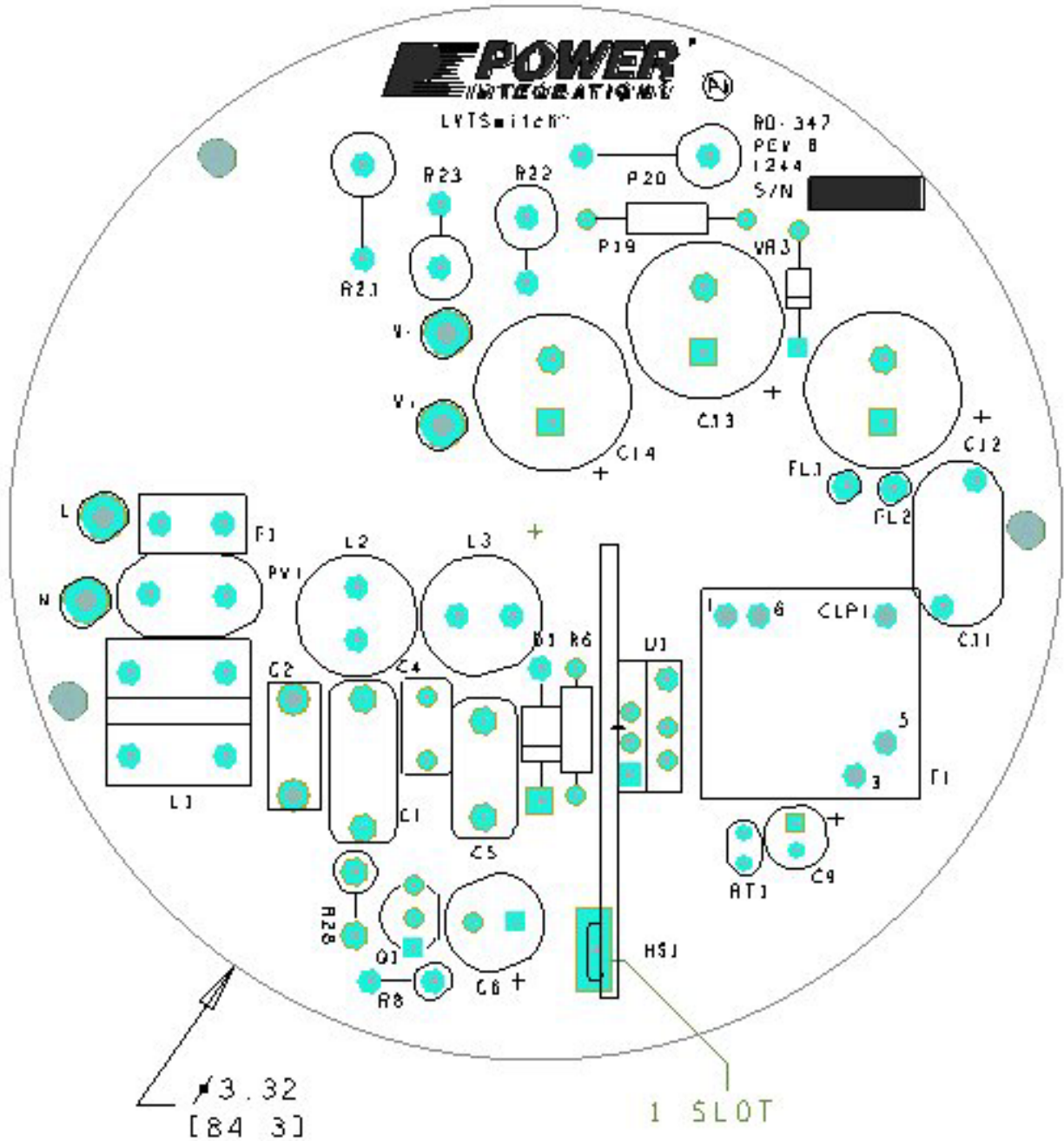

Figure 6 – Top Side.



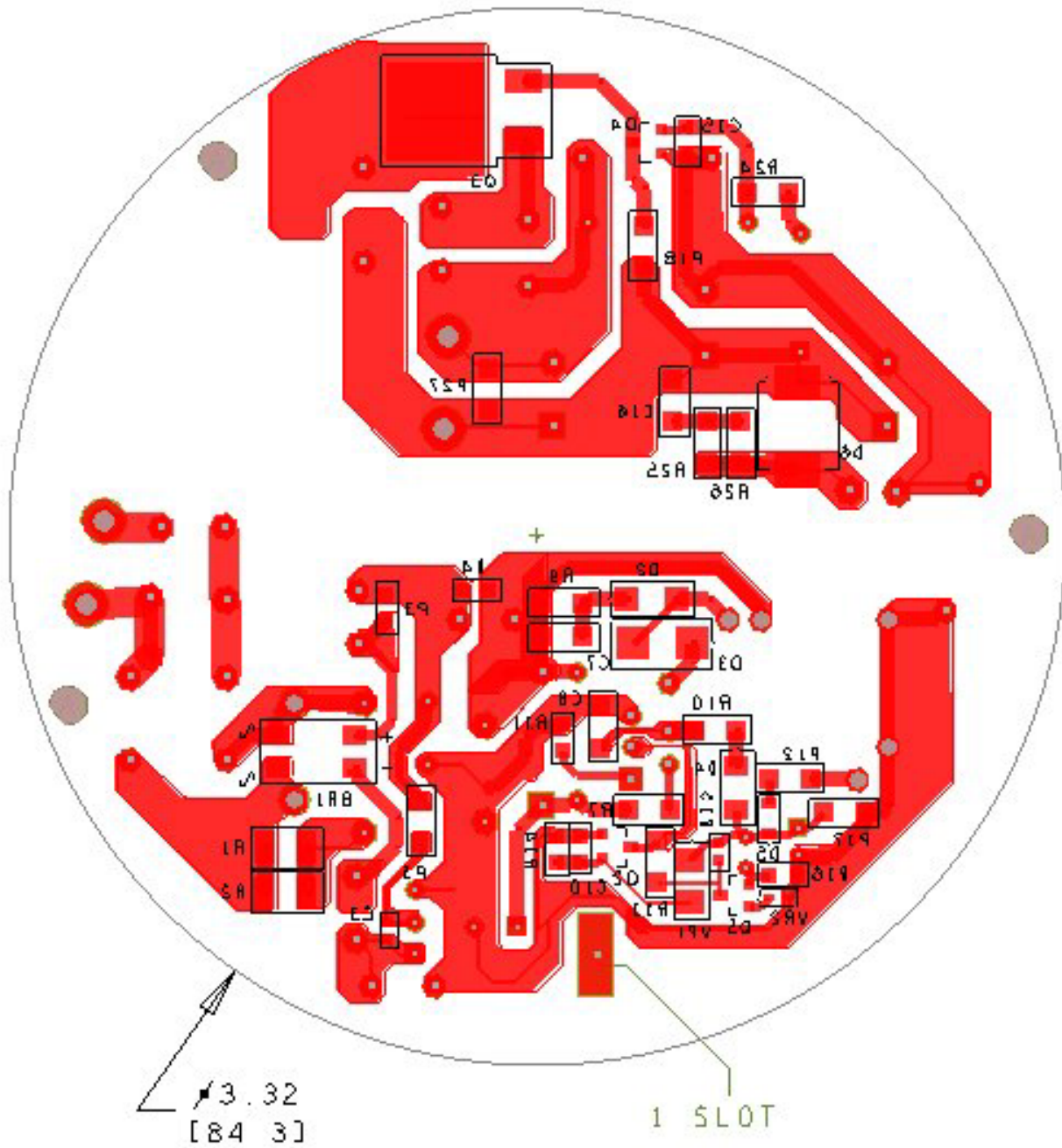

Figure 7 – Bottom Side.



6 Bill of Materials

Item	Qty	Part Ref	Description	Mfg Part Number	Mfg
1	1	BR1	1000 V, 0.8 A, Bridge Rectifier, SMD, MBS-1, 4-SOIC	B10S-G	Comchip
2	1	C1	220 nF, 250 V, Film	ECQ-E2224KF	Panasonic
3	1	C2	33 nF, 310 VAC, Polyester Film, X2	BFC233920333	Vishay
4	1	C3	470 nF, 50 V, Ceramic, Y5G, 0603	C1608Y5V1H474Z	TDK
5	1	C4	47 nF, 250 V, Film	ECQ-E2473KB	Panasonic
6	1	C5	180 nF, 250 V, Film	ECQ-E2184KB	Panasonic
7	1	C6	2.2 μ F, 400 V, Electrolytic, (8 x 11.5)	SMG400VB2R2M8X11LL	Nippon Chemi-Con
8	1	C7	2.2 nF, 630 V, Ceramic, X7R, 1206	ECJ-3FBJ222K	Panasonic
9	1	C8	100 μ F, 10 V, Ceramic, X5R, 1210	C3216X5R1A107M-T	TDK
10	1	C9	22 μ F, 50 V, Electrolytic, Low ESR, 900 m Ω , (5 x 11.5)	ELXZ500ELL220MEB5D	Nippon Chemi-Con
11	2	C10 C15	100 nF, 50 V, Ceramic, X7R, 0805	CC0805KRX7R9BB104	Yageo
12	1	C11	2.2 nF, Ceramic, Y1	440LD22-R	Vishay
13	3	C12 C13 C14	330 μ F, 63, Electrolytic, Low ESR, 85 m Ω , (12.5 x 20)	ELXZ630ELL331MK20S	Nippon Chemi-Con
14	1	C16	220 pF, 630 V, Ceramic, NPO, 1206	C3216C0G2J221J	TDK
15	1	D1	400 V, 1 A, Rectifier, DO-41	1N4004-E3/54	Vishay
16	1	D2	Diode Ultrafast, SW 600 V, 1 A, SMA	US1J-13-F	Diodes, Inc.
17	1	D3	100 V, 3 A, Schottky, DO-214AA	STPS3H100U	ST Micro
18	1	D4	75 V, 0.15 A, Fast Switching, 4 ns, MELF	LL4148-13	Diodes, Inc.
19	1	D5	250 V, 0.2 A, Fast Switching, 50 ns, SOD-323	BAV21WS-7-F	Diodes, Inc.
20	1	D6	200 V, 4 A, Schottky, SMC, DO-214AB	MBRS4201T3G	ON Semi
21	1	F1	2 A, 250 V, Slow, Long Time Lag,RST	RST 2	Belfuse
22	1	L1	5 mH, 0.3 A, Common Mode Choke	SU9V-03050	Tokin
23	2	L2 L3	1mH, 350m A	HTB2-102-281	CUI
24	1	Q1	SCR, 600 V, 1.25 A, TO-92	X0202MA 2BL2	ST Micro
25	3	Q2 Q4 Q5	NPN, Small Signal BJT, 40 V, 0.2 A, SOT-23	MMBT3904LT1G	On Semi
26	1	Q3	NPN, Power BJT, 400 V, 2 A, SOT-428	2SD1760TLR	Rohm
27	2	R1 R2	1 k Ω , 5%, 1/2 W, Thick Film, 1210	ERJ-14YJ102U	Panasonic
28	2	R3 R4	10 k Ω , 5%, 1/8 W, Thick Film, 0805	ERJ-6GEYJ103V	Panasonic
29	1	R5	510 k Ω , 5%, 1/4 W, Thick Film, 1206	ERJ-8GEYJ514V	Panasonic
30	1	R6	510 k Ω , 5%, 1/4 W, Carbon Film	CFR-25JB-510K	Yageo
31	1	R7	2.00 M Ω , 1%, 1/4 W, Thick Film, 1206	ERJ-8ENF2004V	Panasonic
32	1	R8	100 Ω , 5%, 2 W, Metal Oxide	RSMF2JT100R	Stackpole
33	1	R9	390 k Ω , 5%, 1/4 W, Thick Film, 1206	ERJ-8GEYJ394V	Panasonic
34	1	R10	4.7 k Ω , 5%, 1/4 W, Thick Film, 1206	ERJ-8GEYJ472V	Panasonic
35	1	R11	49.9 k Ω , 1%, 1/8 W, Thick Film, 0805	ERJ-6ENF4992V	Panasonic
36	3	R12 R25 R26	39 Ω , 5%, 1/4 W, Thick Film, 1206	ERJ-8GEYJ390V	Panasonic
37	1	R13	174 k Ω , 1%, 1/4 W, Thick Film, 1206	ERJ-8ENF1743V	Panasonic
38	1	R14	1 k Ω , 5%, 1/8 W, Thick Film, 0805	ERJ-6GEYJ102V	Panasonic
39	1	R15	10 k Ω , 1%, 1/16 W, Thick Film, 0603	ERJ-3EKF1002V	Panasonic
40	1	R16	3.48 k Ω , 1%, 1/8 W, Thick Film, 0805	ERJ-6ENF3481V	Panasonic
41	3	R17 R18 R24	20 k Ω , 5%, 1/4 W, Thick Film, 1206	ERJ-8GEYJ203V	Panasonic
42	1	R19	2 k, 5%, 1/4 W, Carbon Film	CFR-25JB-2K0	Yageo
43	1	R20	3 Ω , 5%, 2 W, Metal Oxide	RSF200JB-3R0	Yageo
44	1	R21	100 R, 5%, 2 W, Metal Oxide	RSF200JB-100R	Yageo
45	2	R22 R23	430 Ω , 5%, 3 W, Metal Oxide	ERG-3SJ431	Panasonic
46	1	R28	0 Ω , 5%, 1/4 W, Metal Oxide	Z0R-25-R-52-0R	Yageo



47	1	RT1	NTC Thermistor, 100 k Ω , 0.00014 A	NTSA0WF104EE1B0	Murata
48	1	RV1	140 V, 12 J, 7 mm, RADIAL	V140LA2P	Littlefuse
49	1	T1	Bobbin, RM6, Vertical, 6 pins Transformer	B65808-N1006-D1 SNX-R1664	Epcos Santronics USA
50	1	U1	LYTSwitch, eSIP	LYT4313E	Power Integrations
51	1	VR1	39 V, 5%, 500 mW, DO-213AA (MELF)	ZMM5259B-7	Diodes, Inc.
52	1	VR2	10 V, 5%, 150 mW, SSMINI-2	DZ2S100M0L	Panasonic
53	1	VR4	43 V, 5%, 500 mW, DO-35	1N5260B-T	Diodes, Inc.



7 Transformer Specification

7.1 Electrical Diagram

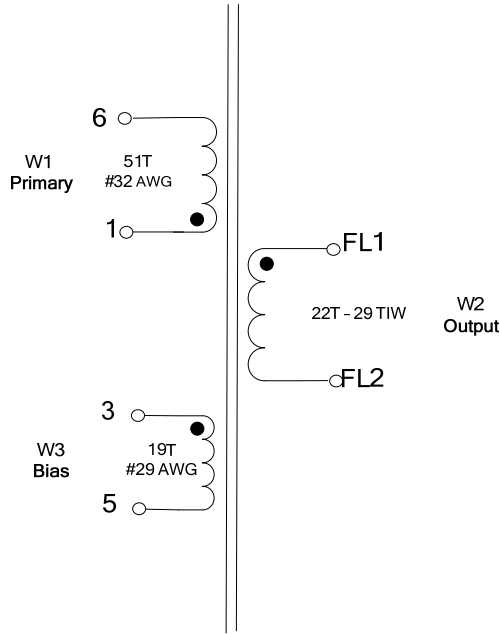

Figure 8 – Transformer Electrical Diagram.

7.2 Electrical Specifications

Electrical Strength	1 second, 60 Hz, from pins 1, 3, 5, 6 to FL1, FL2	3000 VAC
Primary Inductance	Pins 1-6, all other windings open, measured at 132 kHz, 0.4 V _{RMS}	720 μH ±2%
Resonant Frequency	Pins 1-6, all other windings open	1000 kHz (Min.)
Primary Leakage Inductance	Pins 1-6, with FL1-FL2 shorted, measured at 132 kHz, 0.4 V _{RMS}	10 μH max

7.3 Materials

Item	Description
[1]	Core: RM6S/I 3F3.
[2]	B-RM6-V 6pins (3/3) or equivalent. With mounting clip, CLI/P-RM6.
[3]	Tape, Polyester film, 3M 1350F-1 or equivalent, 6.4 mm wide.
[4]	Wire: Magnet, #32 AWG, solderable double coated.
[5]	Wire: Magnet, #29 AWG, solderable double coated.
[6]	Wire, Triple Insulated, Furukawa TEX-E or Equivalent, 29 TIW
[7]	Transformer Varnish, Dolph BC-359 or equivalent.



7.4 Transformer Build Diagram

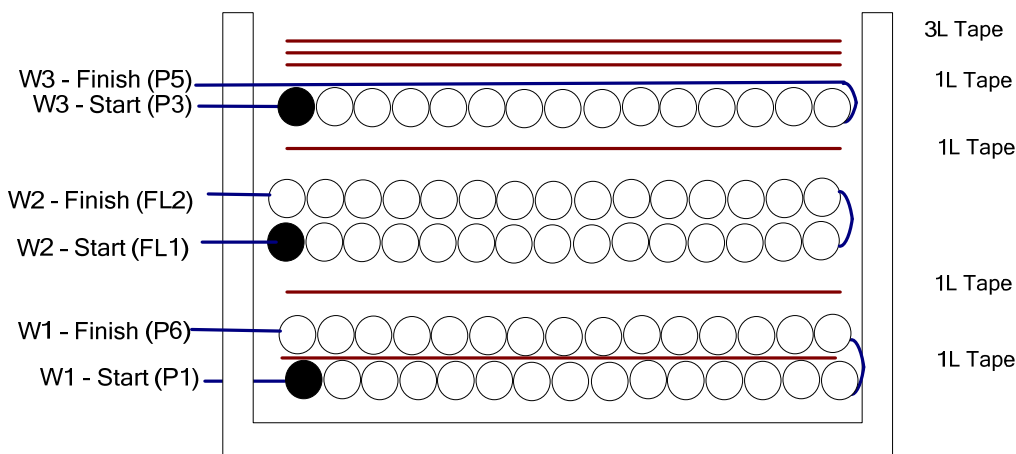

Figure 9 – Transformer Build Diagram.

7.5 Transformer Construction

Bobbin Preparation	Place the bobbin item [2] on the mandrel such that pin side on the left side. Winding direction is the clockwise direction.
WDG 1 (Primary)	Starting at pin 1, wind 51 turns of wire item [4] in two layers. Apply one layer of tape item [3] between 1 st and 2 nd layer. Finish at pin 6.
Insulation	Apply one layer of tape item [3].
WDG 2 (Secondary)	Leave about 2" of wire item [6], use small tape to mark as FL1, wind 22 turns in two layers. At the last turn exit the same slot, leave about 2", and mark as FL2.
Insulation	Apply one layer of tape item [3].
WDG 3 (Bias)	Starting at pin 3, wind 19 turns of wire item [5], spreading the wire, and finish at pin 5.
Finish Wrap	Apply three layers of tape item [3] for finish wrap.
Final Assembly	Cut FL1 to 1.2" and FL2 to 1.5". Grind core to get 720 μ H inductance. Assemble and secure core halves. Dip impregnate using varnish item [7]. Cut pins 2 and 4.



8 U1 Heat Sink Assembly

8.1 U1 Heat Sink Fabrication Drawing

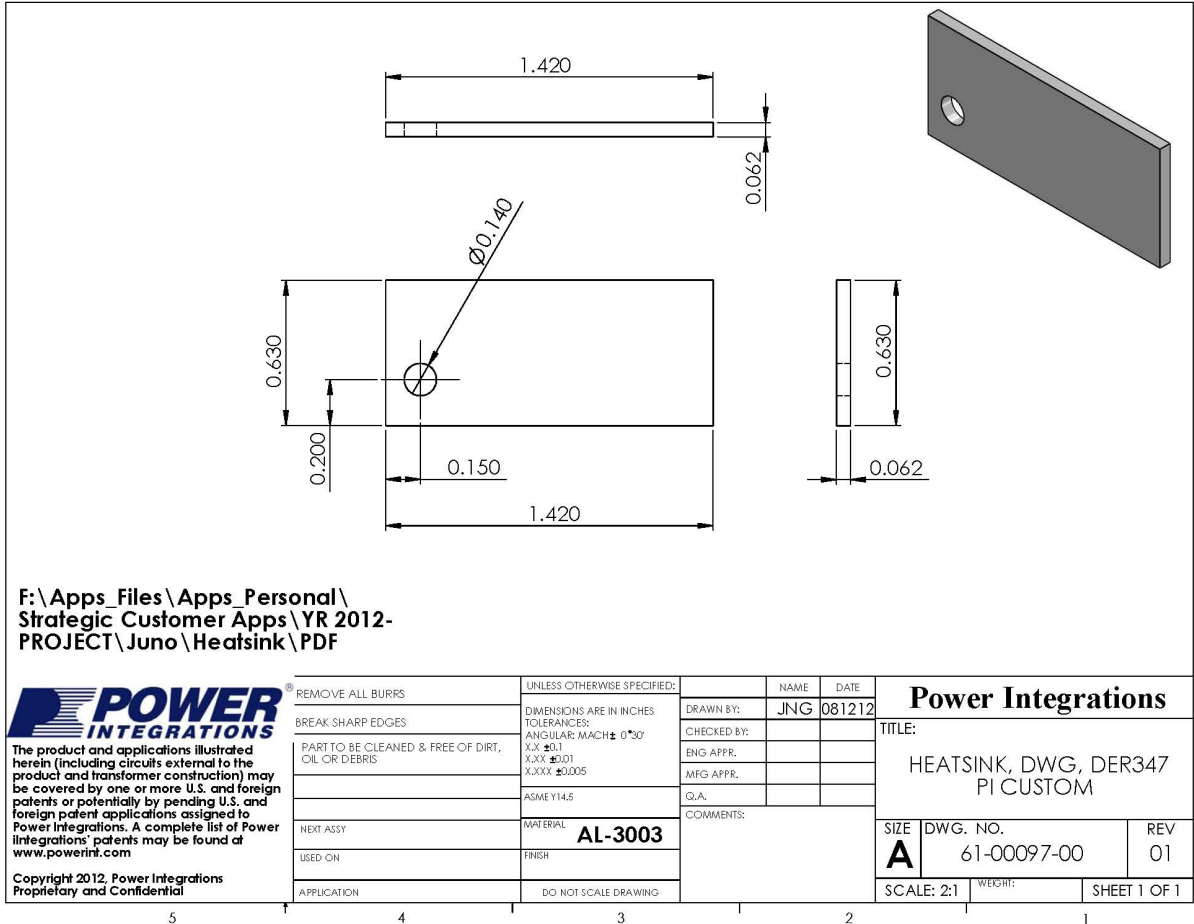

Figure 10 – Heat Sink Fabrication Drawing.



8.2 U1 Heat Sink Assembly Drawing

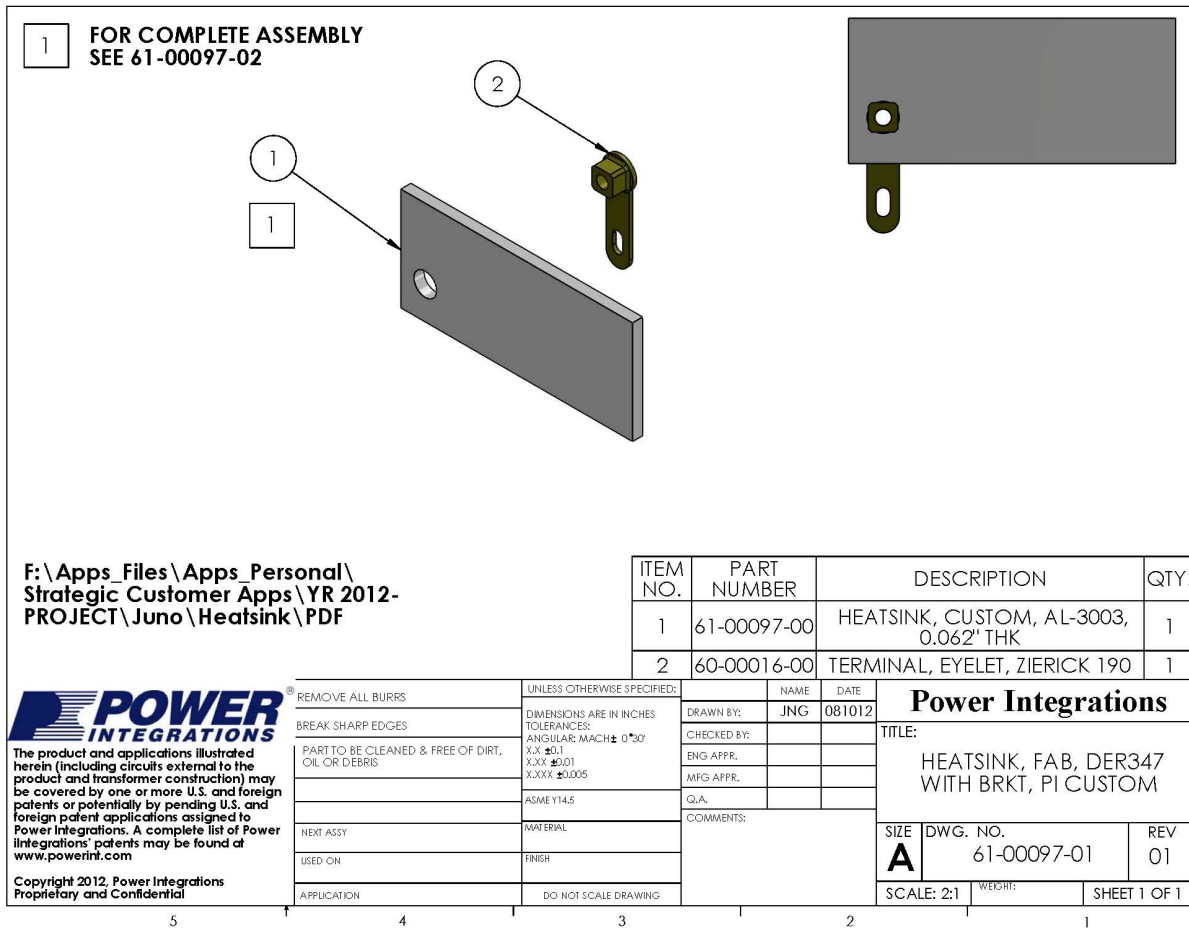

Figure 10a – Heat Sink Fabrication Drawing.



8.3 U1 and Heat Sink Assembly Drawing

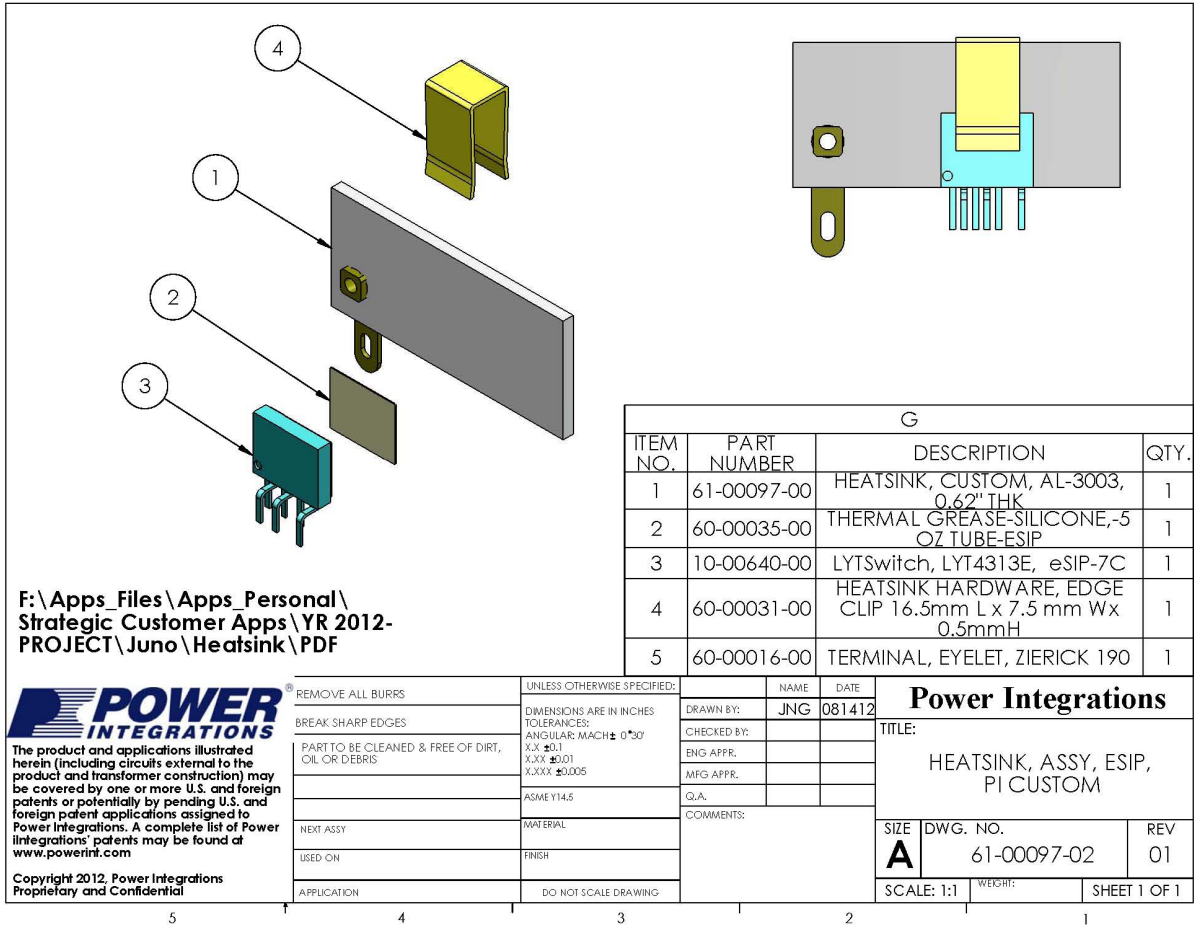

Figure 11 – U1 Heat Sink Assembly Drawing.



9 Performance Data

All measurements performed at room temperature using an LED load. The following data were measured using 3 sets of loads to represent a voltage of 30 V ~ 38 V. The table in Section 9.6 and 16.8 show complete test data values for figures 13 and 12 respectively.

9.1 Efficiency

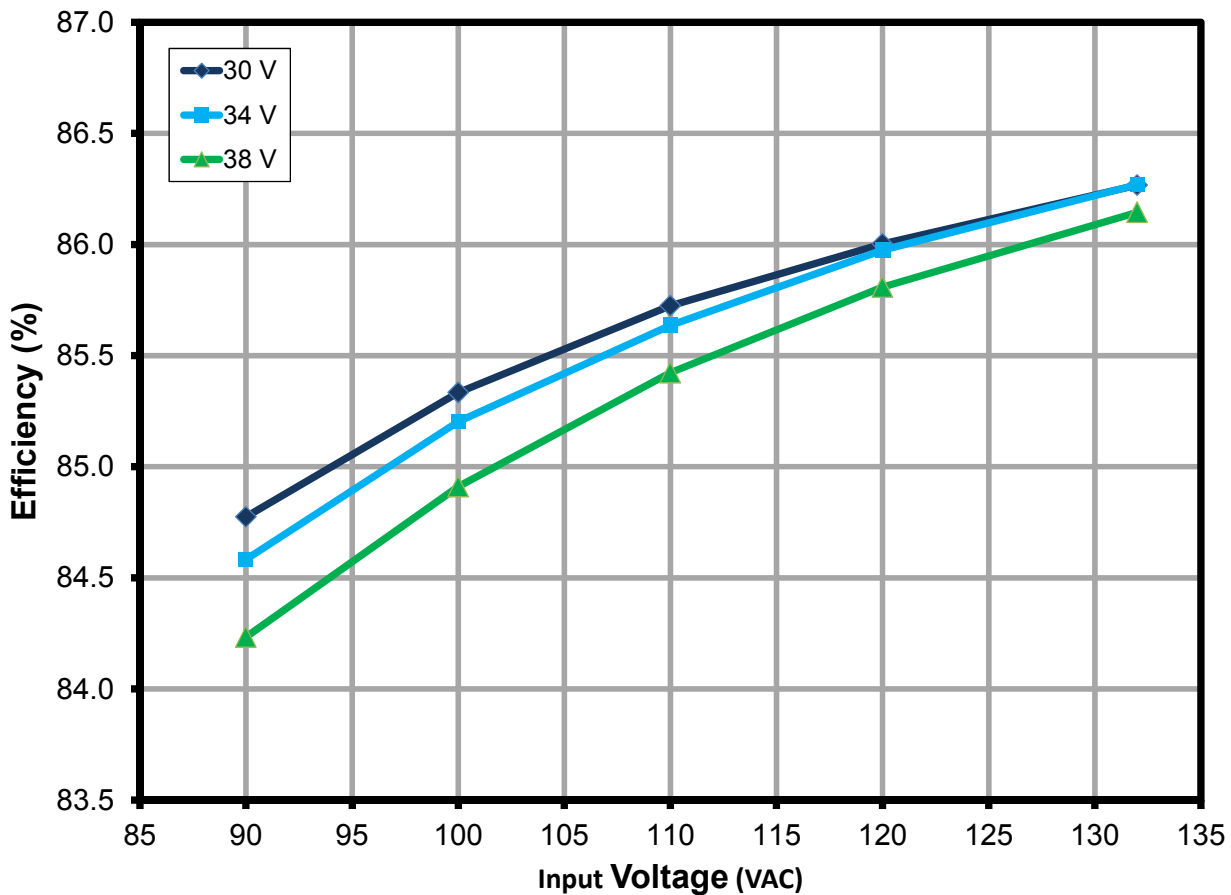

Figure 12 – Efficiency vs. Line and Load from the schematic shown in Figure 4 (Full performance report in Section 16)



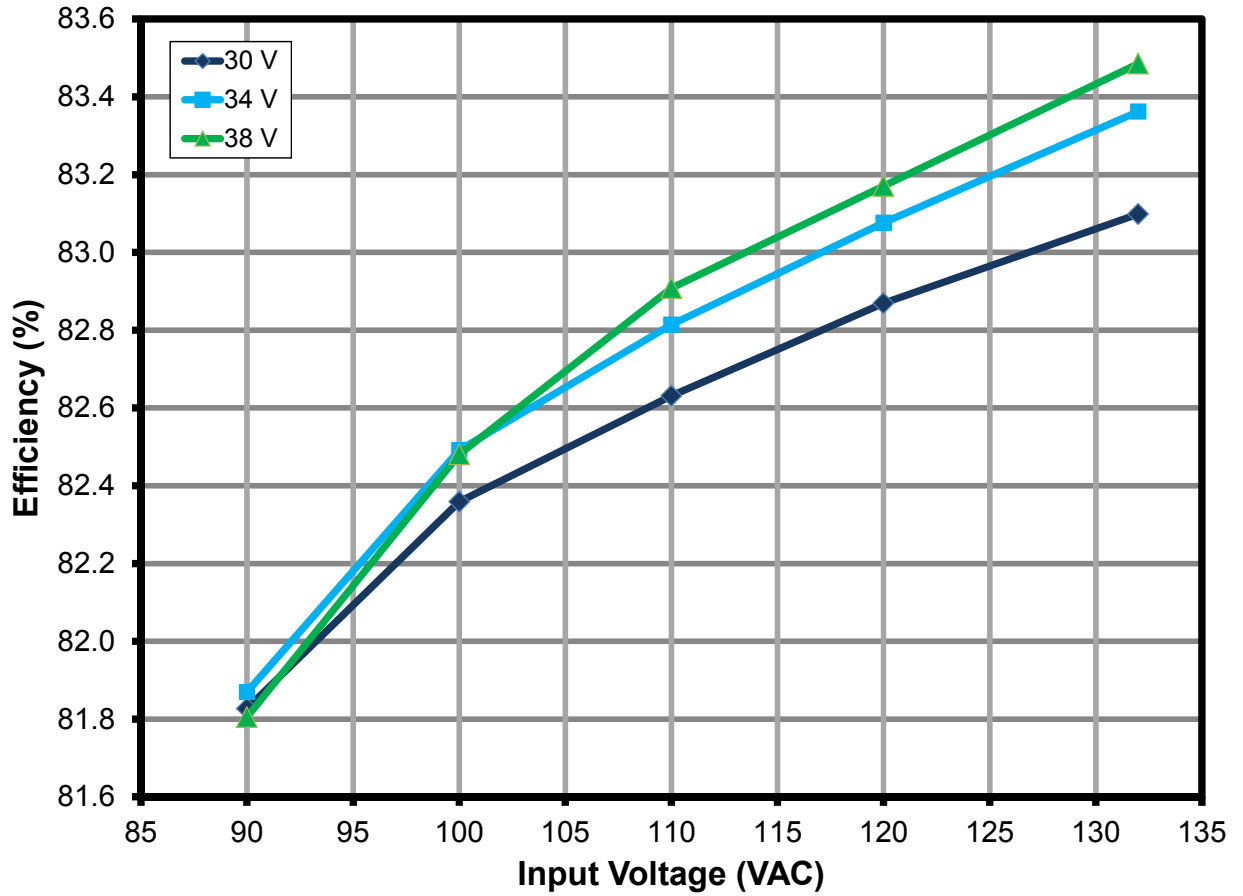

Figure 13 – Efficiency vs. Line and Load from the schematic shown in Figure 5



9.2 Line and Load Regulation

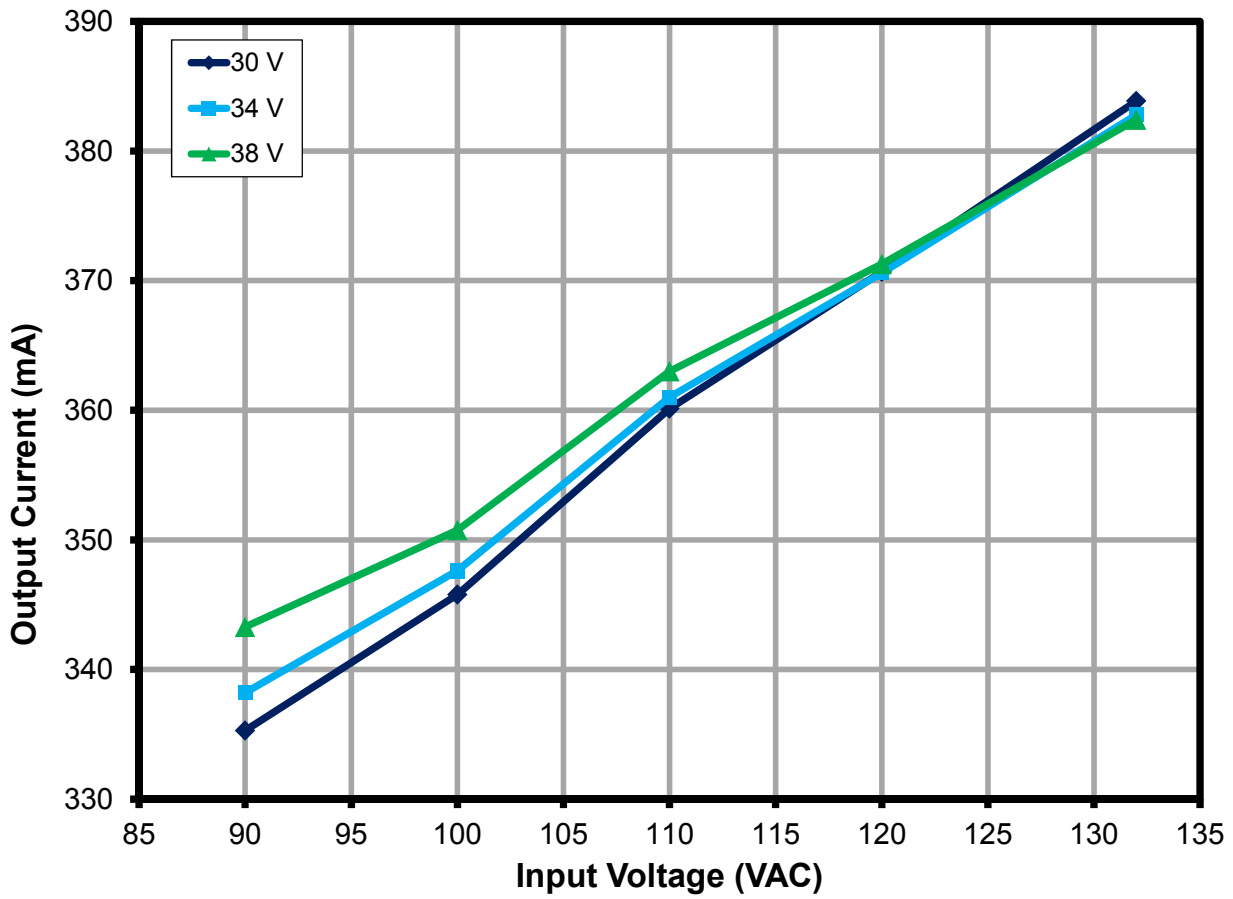

Figure 14 – Regulation vs. Line and Load.



9.3 Power Factor

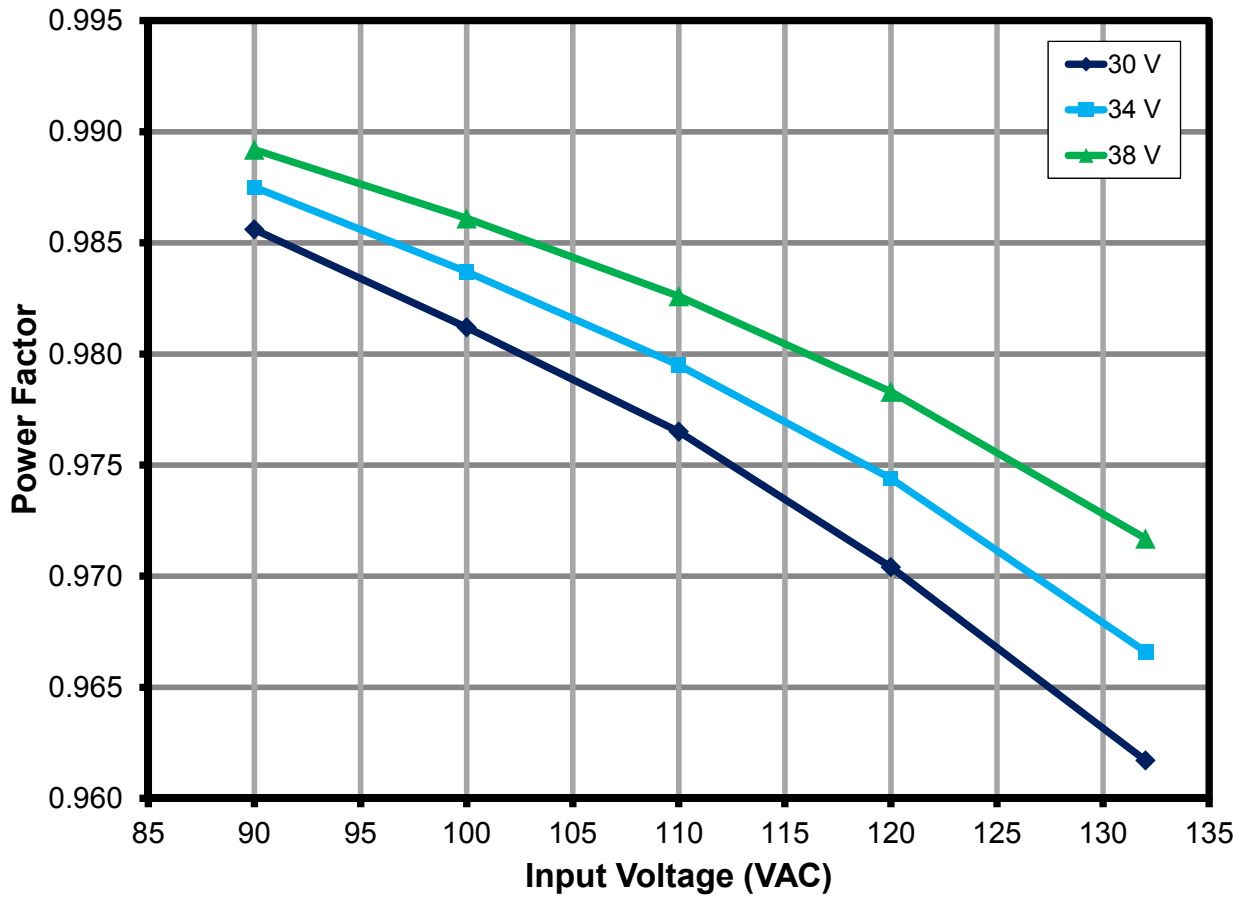

Figure 15 – Power Factor vs. Line and Load.



9.4 A-THD

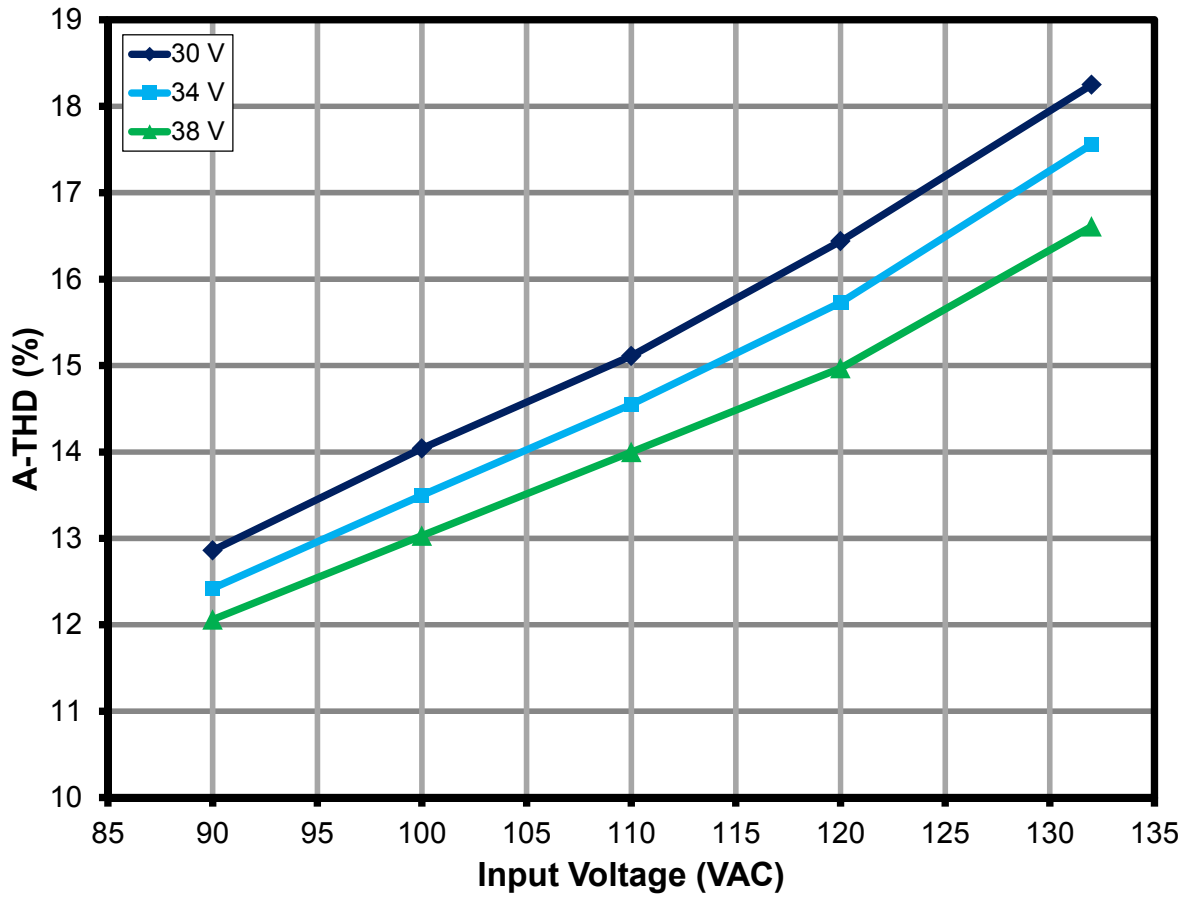

Figure 16 – A-THD vs. Line and Load.



9.5 Harmonic Currents

The design met the limits for Class C equipment for an active input power of <25 W. In this case IEC61000-3-2 specifies that harmonic currents shall not exceed the limits of Class D equipment¹. Therefore the limits shown in the charts below are Class D limits which must not be exceeded to meet Class C compliance.

9.5.1 30 V LED Load

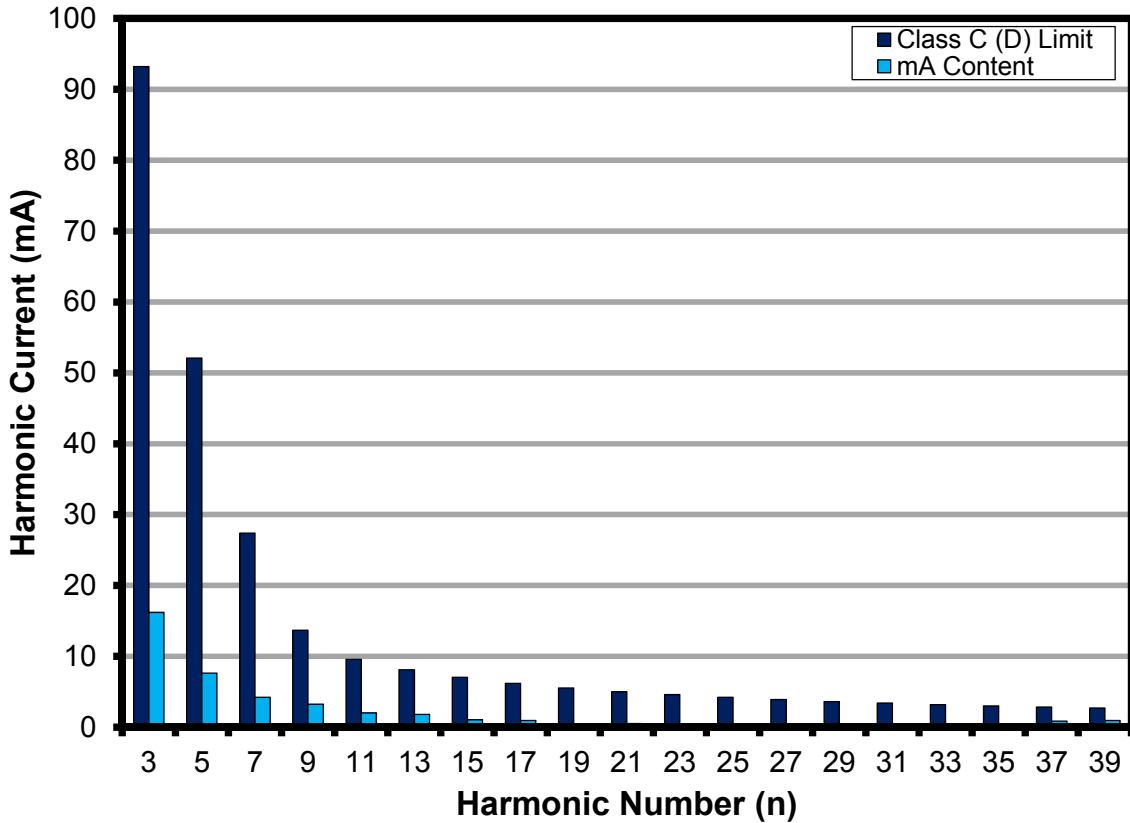

Figure 17 – 30 V LED Load Input Current Harmonics case (IEC61000-3-2) at 120 VAC, 60 Hz.

¹ IEC6000-3-2 Section 7.3, table 2, column 2.



9.5.3 34 V LED Load

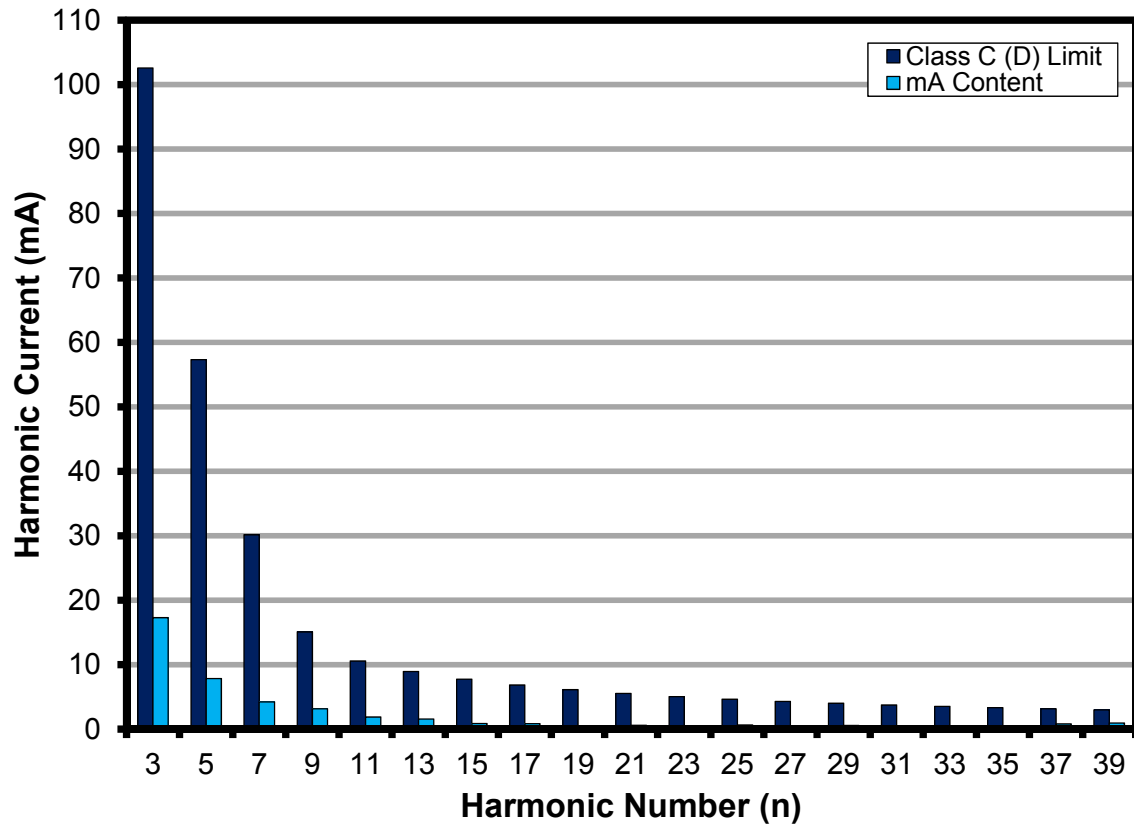

Figure 18 – 34 V LED Load Input Current Harmonics (IEC61000-3-2) at 120 VAC, 60 Hz.



9.5.4 38 V LED Load

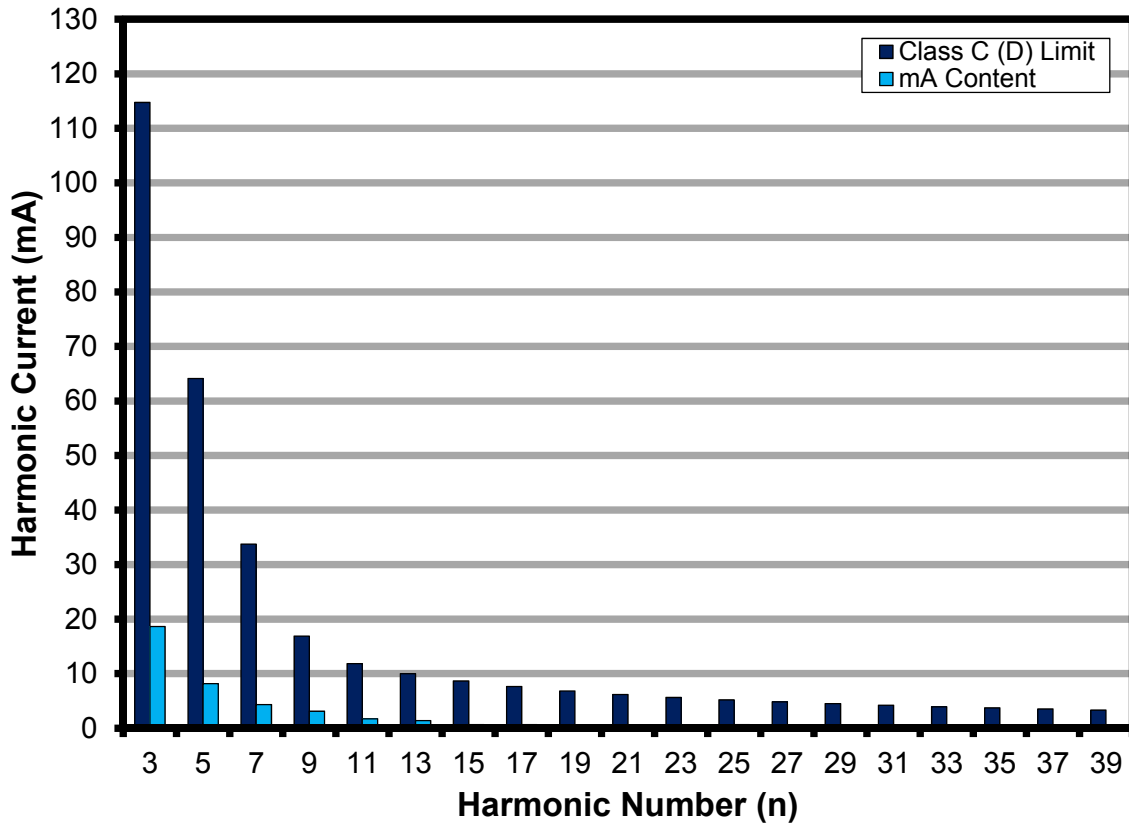

Figure 19 – 38 V LED Load Input Current Harmonics (IEC61000-3-2) at 120 VAC, 60 Hz.



9.6 Test Data

All measurements were taken with the board at open frame, 25 °C ambient, and 60 Hz line frequency.

9.6.1 Test Data, 30 V LED Load

Input		Input Measurement					Load Measurement			Calculation		
VAC (V _{RMS})	Freq (Hz)	V _{IN} (V _{RMS})	I _{IN} (mA _{RMS})	P _{IN} (W)	PF	%ATHD	V _{OUT} (V _{DC})	I _{OUT} (mA _{DC})	P _{OUT} (W)	P _{CAL} (W)	Efficiency (%)	Loss (W)
90	60	90.05	140.61	12.480	0.986	12.86	30.44	335.28	10.21	10.21	81.83	2.27
100	60	100.02	130.53	12.811	0.981	14.04	30.50	345.77	10.55	10.55	82.36	2.26
110	60	110.08	124.04	13.334	0.977	15.11	30.58	360.12	11.02	11.01	82.63	2.32
120	60	120.06	117.65	13.706	0.970	16.44	30.62	370.67	11.36	11.35	82.87	2.35
132	60	132.09	111.65	14.182	0.962	18.25	30.68	383.86	11.79	11.78	83.10	2.40

9.6.2 Test Data, 34 V LED Load

Input		Input Measurement					Load Measurement			Calculation		
VAC (V _{RMS})	Freq (Hz)	V _{IN} (V _{RMS})	I _{IN} (mA _{RMS})	P _{IN} (W)	PF	%ATHD	V _{OUT} (V _{DC})	I _{OUT} (mA _{DC})	P _{OUT} (W)	P _{CAL} (W)	Efficiency (%)	Loss (W)
90	60	90.05	155.56	13.833	0.988	12.42	33.48	338.20	11.33	11.32	81.87	2.51
100	60	100.02	143.85	14.153	0.984	13.5	33.58	347.62	11.68	11.67	82.49	2.48
110	60	110.08	136.37	14.704	0.980	14.55	33.72	361.02	12.18	12.17	82.81	2.53
120	60	120.05	128.95	15.085	0.974	15.73	33.81	370.59	12.53	12.53	83.08	2.55
132	60	132.08	122.07	15.585	0.967	17.56	33.93	382.80	12.99	12.99	83.36	2.59

9.6.3 Test Data, 38 V LED Load

Input		Input Measurement					Load Measurement			Calculation		
VAC (V _{RMS})	Freq (Hz)	V _{IN} (V _{RMS})	I _{IN} (mA _{RMS})	P _{IN} (W)	PF	%ATHD	V _{OUT} (V _{DC})	I _{OUT} (mA _{DC})	P _{OUT} (W)	P _{CAL} (W)	Efficiency (%)	Loss (W)
90	60	90.04	177.40	15.801	0.989	12.06	37.64	343.28	12.93	12.92	81.80	2.88
100	60	100.01	162.51	16.028	0.986	13.03	37.68	350.74	13.22	13.21	82.48	2.81
110	60	110.07	152.88	16.534	0.983	14	37.75	363.01	13.71	13.70	82.91	2.83
120	60	120.05	143.69	16.875	0.978	14.97	37.78	371.28	14.04	14.03	83.17	2.84
132	60	132.08	135.12	17.342	0.972	16.61	37.84	382.42	14.48	14.47	83.49	2.86



9.6.4 120 VAC 60 Hz, 30 V LED Load Harmonics Data

Current Harmonics Limits for IEC61000-3-2

V	Freq	I (mA)	P	PF	%THD
120	60.00	117.65	13.7060	0.9704	16.44
nth Order	mA Content	% Content	Limit <25 W	Limit >25 W	Remarks
1	115.81				
2	0.05	0.04%		2.00%	
3	16.21	14.00%	93.2008	29.11%	Pass
5	7.63	6.59%	52.0828	10.00%	Pass
7	4.22	3.64%	27.4120	7.00%	Pass
9	3.27	2.82%	13.7060	5.00%	Pass
11	2.04	1.76%	9.5942	3.00%	Pass
13	1.80	1.55%	8.1182	3.00%	Pass
15	1.07	0.92%	7.0357	3.00%	Pass
17	0.98	0.85%	6.2080	3.00%	Pass
19	0.46	0.40%	5.5545	3.00%	Pass
21	0.54	0.47%	5.0255	3.00%	Pass
23	0.20	0.17%	4.5885	3.00%	Pass
25	0.50	0.43%	4.2214	3.00%	Pass
27	0.23	0.20%	3.9087	3.00%	Pass
29	0.48	0.41%	3.6392	3.00%	Pass
31	0.32	0.28%	3.4044	3.00%	Pass
33	0.41	0.35%	3.1981	3.00%	Pass
35	0.41	0.35%	3.0153	3.00%	Pass
37	0.86	0.74%	2.8523	3.00%	Pass
39	0.95	0.82%	2.7061	3.00%	Pass
41	0.31	0.27%			
43	0.35	0.30%			
45	0.22	0.19%			
47	0.22	0.19%			
49	0.26	0.22%			



9.6.5 120 VAC 60 Hz, 34 V LED Load Harmonics Data

Current Harmonics Limits for IEC61000-3-2

V	Freq	I (mA)	P	PF	%THD
120	60.00	128.95	15.0850	0.9744	15.73
nth Order	mA Content	% Content	Limit <25 W	Limit >25 W	Remarks
1	127.04				
2	0.04	0.03%		2.00%	
3	17.29	13.61%	102.5780	29.23%	Pass
5	7.84	6.17%	57.3230	10.00%	Pass
7	4.23	3.33%	30.1700	7.00%	Pass
9	3.16	2.49%	15.0850	5.00%	Pass
11	1.86	1.46%	10.5595	3.00%	Pass
13	1.58	1.24%	8.9350	3.00%	Pass
15	0.86	0.68%	7.7436	3.00%	Pass
17	0.83	0.65%	6.8326	3.00%	Pass
19	0.35	0.28%	6.1134	3.00%	Pass
21	0.60	0.47%	5.5312	3.00%	Pass
23	0.28	0.22%	5.0502	3.00%	Pass
25	0.62	0.49%	4.6462	3.00%	Pass
27	0.37	0.29%	4.3020	3.00%	Pass
29	0.57	0.45%	4.0053	3.00%	Pass
31	0.41	0.32%	3.7469	3.00%	Pass
33	0.40	0.31%	3.5198	3.00%	Pass
35	0.43	0.34%	3.3187	3.00%	Pass
37	0.80	0.63%	3.1393	3.00%	Pass
39	0.94	0.74%	2.9783	3.00%	Pass
41	0.22	0.17%			
43	0.32	0.25%			
45	0.27	0.21%			
47	0.23	0.18%			
49	0.31	0.24%			



9.6.6 120 VAC 60 Hz, 38 V LED Load Harmonics Data

Current Harmonics Limits for IEC61000-3-2

V	Freq	I (mA)	P	PF	%THD
120	60.00	143.69	16.8750	0.9783	14.97
Current Harmonics Limits for IEC61000-3-2					
nth Order	mA Content	% Content	Limit <25 W	Limit >25 W	Remarks
1	141.79				
2	0.07	0.05%		2.00%	
3	18.62	13.13%	114.7500	29.35%	Pass
5	8.15	5.75%	64.1250	10.00%	Pass
7	4.32	3.05%	33.7500	7.00%	Pass
9	3.11	2.19%	16.8750	5.00%	Pass
11	1.74	1.23%	11.8125	3.00%	Pass
13	1.40	0.99%	9.9952	3.00%	Pass
15	0.68	0.48%	8.6625	3.00%	Pass
17	0.68	0.48%	7.6434	3.00%	Pass
19	0.20	0.14%	6.8388	3.00%	Pass
21	0.58	0.41%	6.1875	3.00%	Pass
23	0.26	0.18%	5.6495	3.00%	Pass
25	0.66	0.47%	5.1975	3.00%	Pass
27	0.40	0.28%	4.8125	3.00%	Pass
29	0.61	0.43%	4.4806	3.00%	Pass
31	0.45	0.32%	4.1915	3.00%	Pass
33	0.44	0.31%	3.9375	3.00%	Pass
35	0.45	0.32%	3.7125	3.00%	Pass
37	0.35	0.25%	3.5118	3.00%	Pass
39	0.42	0.30%	3.3317	3.00%	Pass
41	0.26	0.18%			
43	0.35	0.25%			
45	0.31	0.22%			
47	0.27	0.19%			
49	0.33	0.23%			



10 Dimming Performance Data

TRIAC dimming results were taken at an input voltage of 120 VAC, 60 Hz line frequency, room temperature, and a nominal 34 V LED load.

The output current high limit I_{OUT} (HL) and low limit I_{OUT} (LL) were incorporated based on the NEMA SSL6-2010 (section 4, page 9). The limits incorporated on the succeeding graphs assumes that 100% relative light output falls on the maximum operating output current of 530 mA and 0 mA is 0% light output.

10.1 Dimming Curve with Simulated TRIAC

Agilent 6812B AC source programmed as perfect leading edge dimmer

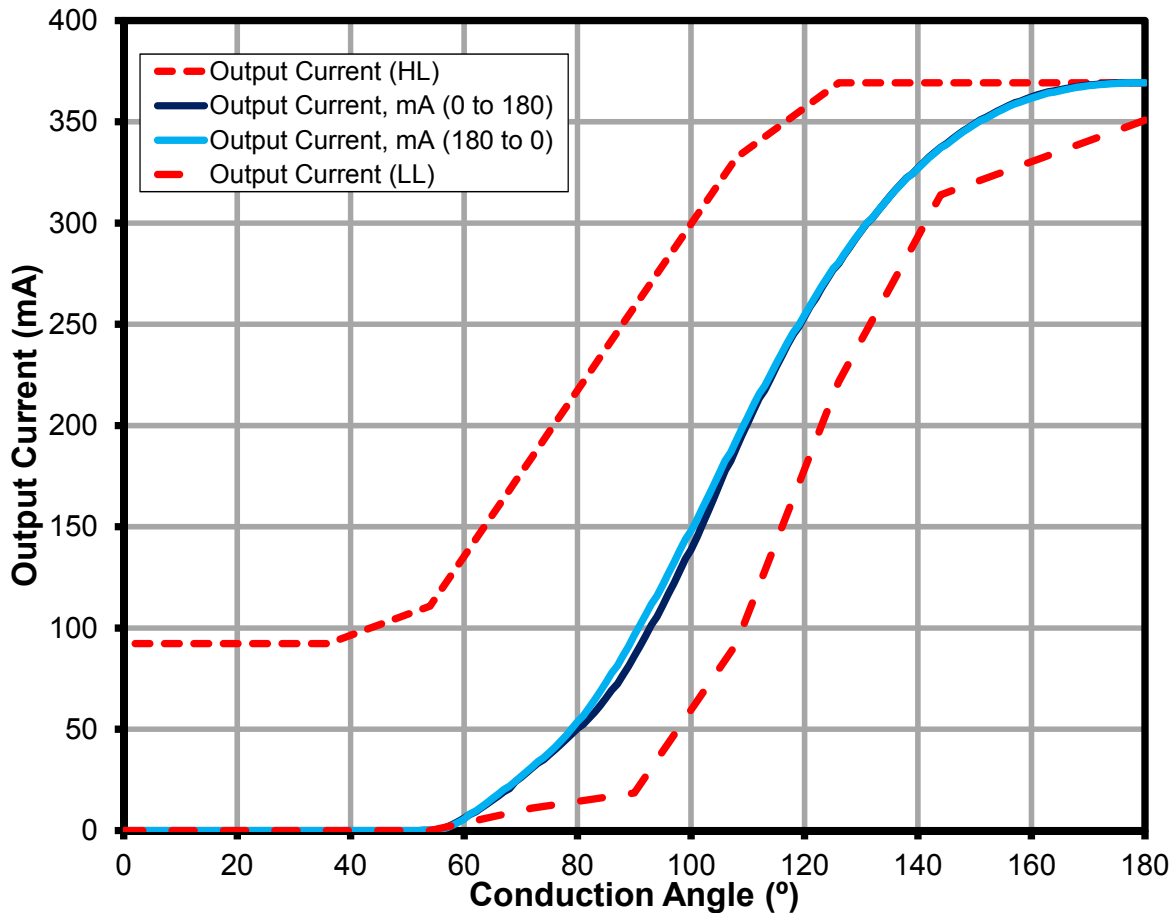

Figure 20 – Dimming Curve at 120 VAC, 60 Hz Input.



10.2 Dimmer Compatibility List

The following dimmers were tested with utility line input (~120 VAC, 60 Hz) and ~34 V LED Load.

	List of Dimmers	Type	Part Number	Max I _{OUT} (mA)	Min I _{OUT} (mA)	Dim Ratio
1	LUTRON LG600PH-LA	L	LG-600PH-WH	331	<0.1	>3310
2	LUTRON S603P	L	S-603P-WH	335	<0.1	>3350
3	LUTRON SLV600P	L	SLV600P-WH	340	<0.1	>3400
4	LUTRON S600	L	S-600-WH	364	<0.1	>3640
5	LUTRON S-600PH-WH	L	S-600PH-WH	338	<0.1	>3380
6	LUTRON DVCL153P	L	DVWCL-153-PLH-WH	324	<0.1	>3240
7	LUTRON DV603P	L	DV-603P-WH	336	<0.1	>3360
8	LUTRON DV600P	L	DV-600P-WH	337	<0.1	>3370
9	LUTRON TG600PH-IV	L	TG-600PH-WH	349	<0.1	>3490
10	LUTRON AY600P	L	AY-600P-WH	342	<0.1	>3420
11	LUTRON GL600P-WH	L	GL-600P-WH	337	<0.1	>3370
12	LEVITON 6633PLI	L	R62-06633-1LW	375	<0.1	>3750
13	LEVITON 6631-LI	L	R62-06631-1LW	353	<0.1	>3530
14	LEVITON IPI06	L	R60-IPI06-1LM	370	<0.1	>3700
15	LEVITON 6161-I	E	R52-06161-00W	341	13	26
16	LEVITON RP106	L	R52-RPI06-1LW	375	<0.1	>3750
17	LEVITON 6681	L	R60-06681-0IW	367	<0.1	>3670
18	LEVITON TGM10-1LW	L	TGM10-1LW	298	<0.1	>2980
19	LEVITON 6684	L	R60-06684-1IW	379	<0.1	>3790
20	LEVITON 6683	L	6683	380	<0.1	>3800
21	LEVITON 6613	L	R02-06613-PLW	376	<0.1	>3760
22	COOPER SLC03	L	SLC03P-W-K-L	352	1.8	196
23	LUTRON GL600-WH	L	GL-600-WH	363	<0.1	>3630
24	LUTRON DVPDC-203P-WH	L	DVPDC-203P-WH	359	21	17
25	LUTRON LX600PL	L	LX-600PL-wh	356	<0.1	>3560
26	LUTRON D600P	L	D-600P-WH	324	<0.1	>3240
27	LUTRON CTCL-153PDH	L		329	<0.1	>3290
28	LUTRON S-600P	L	S-600P	340	<0.1	>3400
29	LUTRON TGLV-600P	L	TGLV-600P	347	<0.1	>3470
30	LUTRON TGLV-600PR	L	TGLV-600PR	344	<0.1	>3440
31	LUTRON TT-300NLH-WH	L	TT-300NLH-WH	368	<0.1	>3680
32	LUTRON TT-300H-WH	L	TT-300H-WH	367	<0.1	>3670
33	LUTRON NLV-1000-WH	L	NLV-1000-WH	350	<0.1	>3500

Figure 21 – Dimmer Compatibility List (L: leading, E: Electronic).



11 Thermal Performance

Images captured after running for >30 minutes at room temperature (25 °C), open frame for the conditions specified.

11.1 Non-Dimming $V_{IN} = 90\text{ VAC}$, 60 Hz, 34 V LED Load

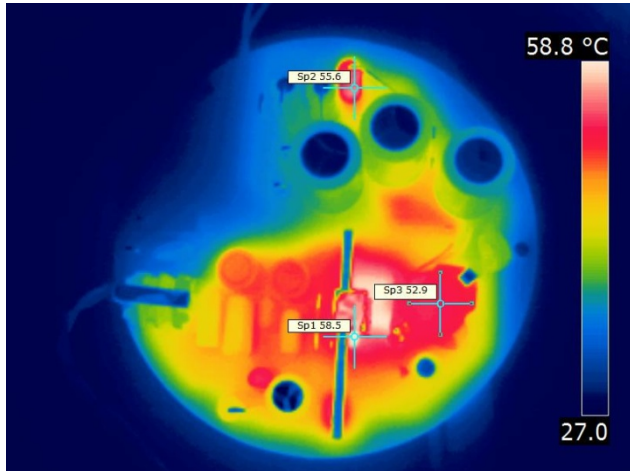

Figure 22 – Top Side.

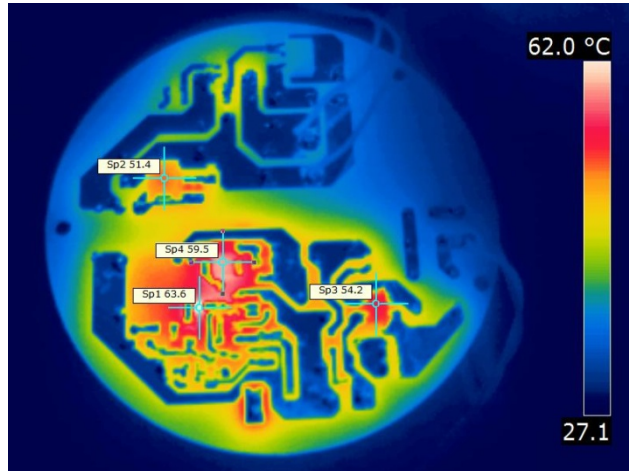

Figure 23 – Bottom Side.

11.2 Non-Dimming $V_{IN} = 132\text{ VAC}$, 60 Hz, 34 V LED Load

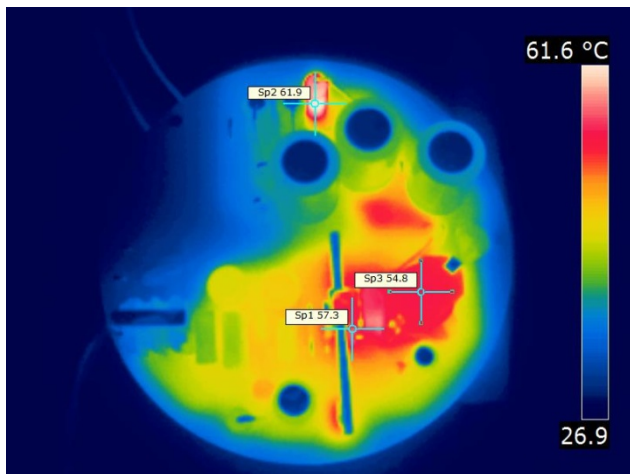

Figure 24 – Top Side.

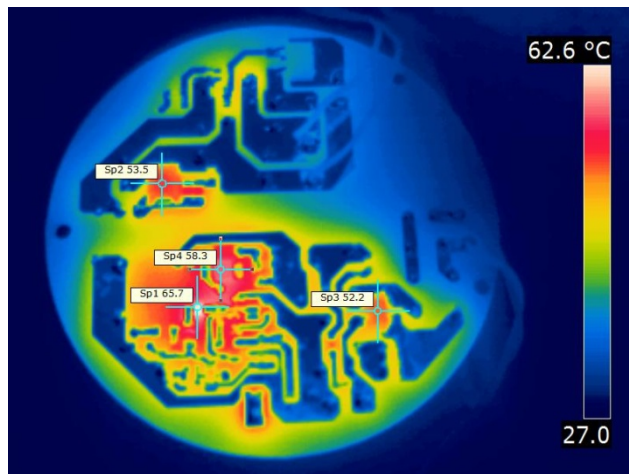

Figure 25 – Bottom Side.



11.3 Dimming $V_{IN} = 120 \text{ VAC}$, 60 Hz, 90° Conduction Angle, 34 V LED Load

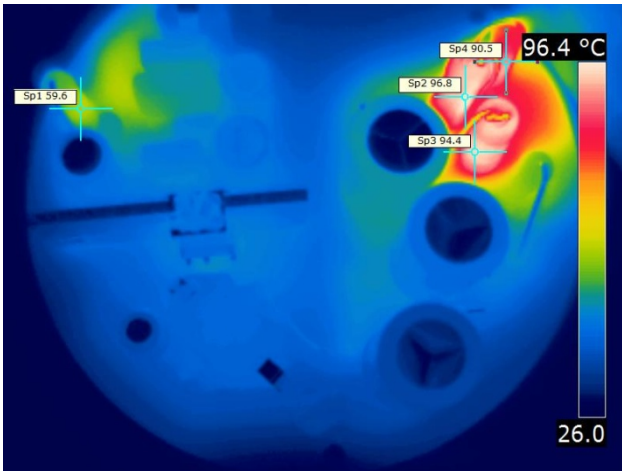

Figure 26 – Top Side.

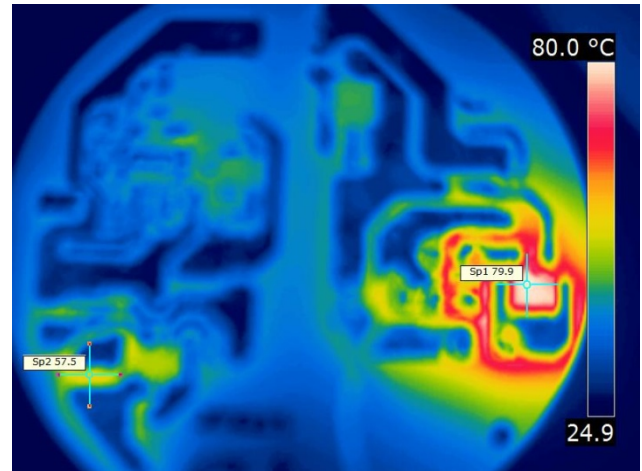

Figure 27 – Bottom Side.

In Figure 24, the active pre-load components R21, R22, and R23 reads 90.5 °C, 96.8 °C and 94.4 °C respectively, can be potted or connect close to heat sink to reduce the temperature.

12 Non-Dimming Waveforms

12.1 Input Voltage and Input Current Waveforms

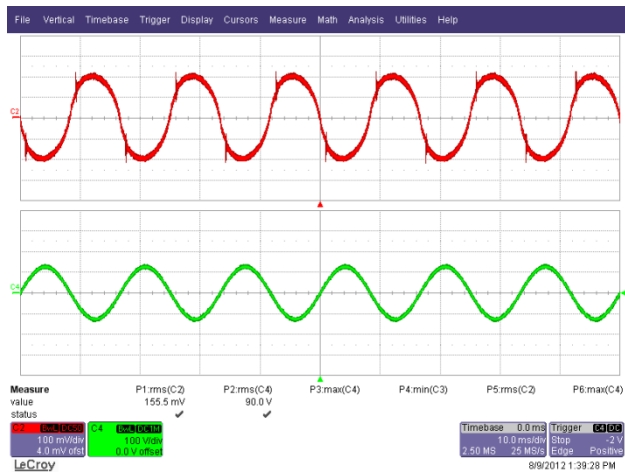

Figure 28 – 90 VAC, Full Load.
 Upper: I_{IN} , 100 mA / div.
 Lower: V_{IN} , 100 V, 10 ms / div.

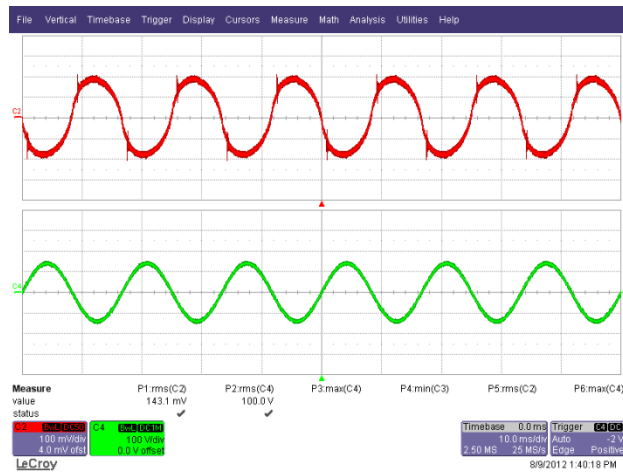

Figure 29 – 100 VAC, Full Load.
 Upper: I_{IN} , 100 mA / div.
 Lower: V_{IN} , 100 V, 10 ms / div.

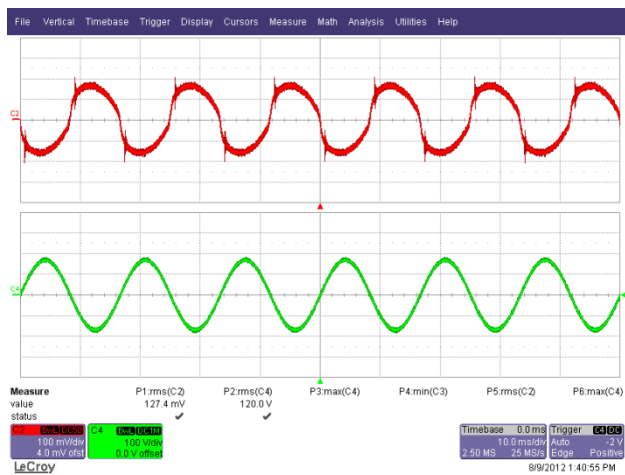

Figure 30 – 120 VAC, Full Load.
 Upper: I_{IN} , 100 mA / div.
 Lower: V_{IN} , 100 V, 10 ms / div.

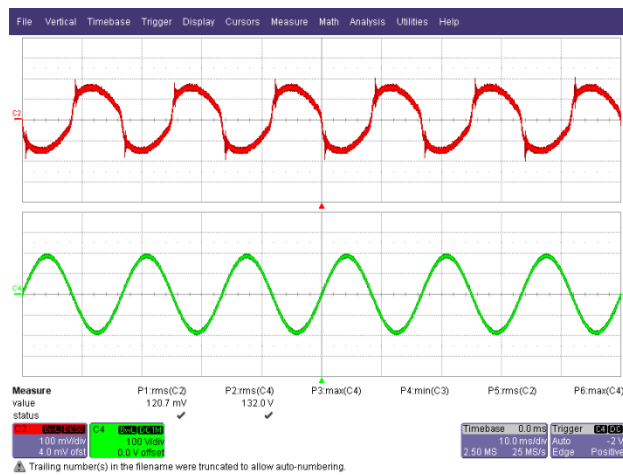

Figure 31 – 132 VAC, Full Load.
 Upper: I_{IN} , 100 mA / div.
 Lower: V_{IN} , 100 V, 10 ms / div.



12.2 Output Current and Output Voltage at Normal Operation

12.2.1 990 μ F Output Capacitance

Input Condition	I _{OUT} , Mean (mA)	I _{OUT} , Peak to Peak (mA)	I _{OUT} Ripple (%)
90 VAC, 60 Hz	331	58	±8.8
100 VAC, 60 Hz	341	67	±9.8
120 VAC, 60 Hz	364	70	±9.6
132 VAC, 60 Hz	376	70	±9.3

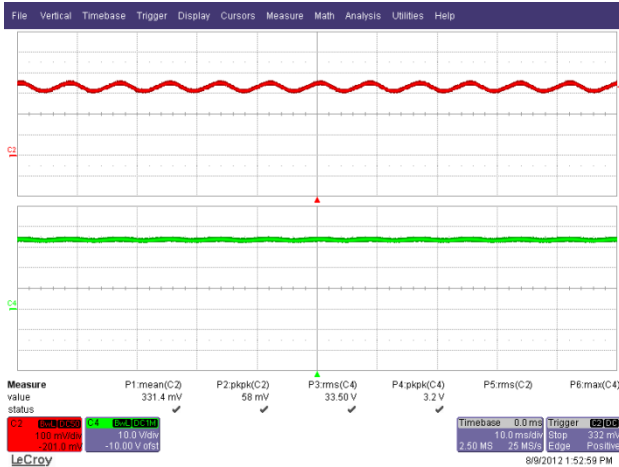

Figure 32 – 90 VAC, 60 Hz Full Load.
Upper: I_{OUT}, 100 mA / div.
Lower: V_{OUT}, 10 V, 10 ms / div.

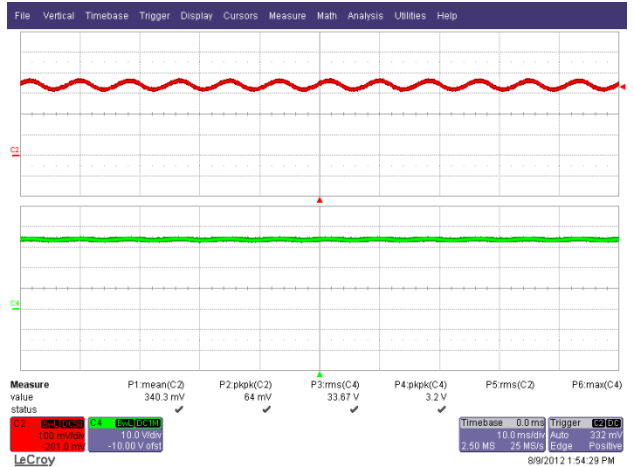

Figure 33 – 100 VAC, 60 Hz Full Load.
Upper: I_{OUT}, 100 mA / div.
Lower: V_{OUT}, 10 V, 10 ms / div.

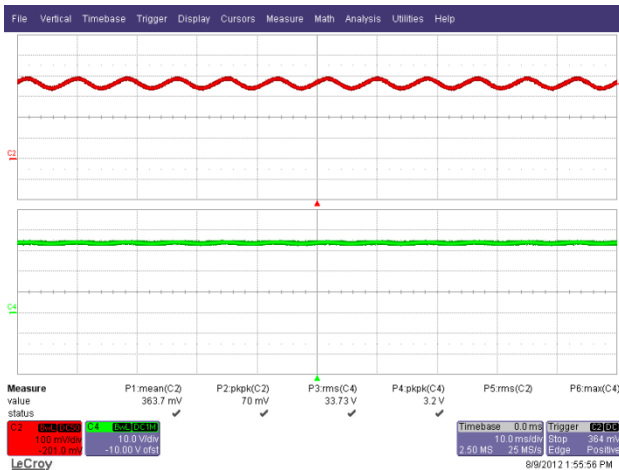

Figure 34 – 120 VAC, 60 Hz Full Load.
Upper: I_{OUT}, 100 mA / div.
Lower: V_{OUT}, 10 V, 10 ms / div.

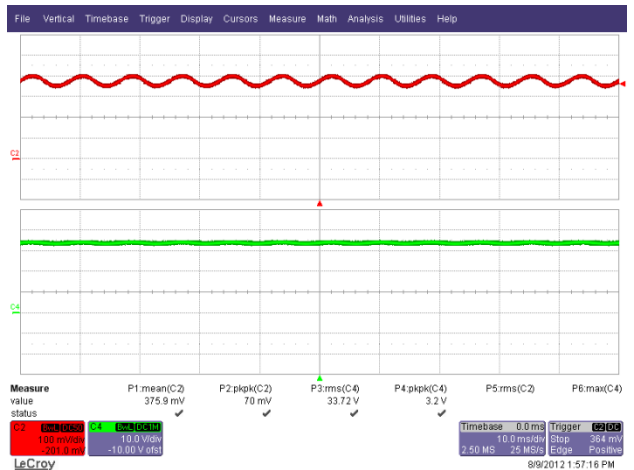

Figure 35 – 132 VAC, 60 Hz Full Load.
Upper: I_{OUT}, 100 mA / div.
Lower: V_{OUT}, 10 V, 10 ms / div.



12.2.2 220 μ F Output Capacitance

Input Condition	I _{OUT} , Mean (mA)	I _{OUT} , Peak to Peak (mA)	I _{OUT} Ripple (%)
90 VAC, 60 Hz	336	211	\pm 31.4
100 VAC, 60 Hz	345	213	\pm 30.9
120 VAC, 60 Hz	367	220	\pm 29.97
132 VAC, 60 Hz	381	229	\pm 30.05

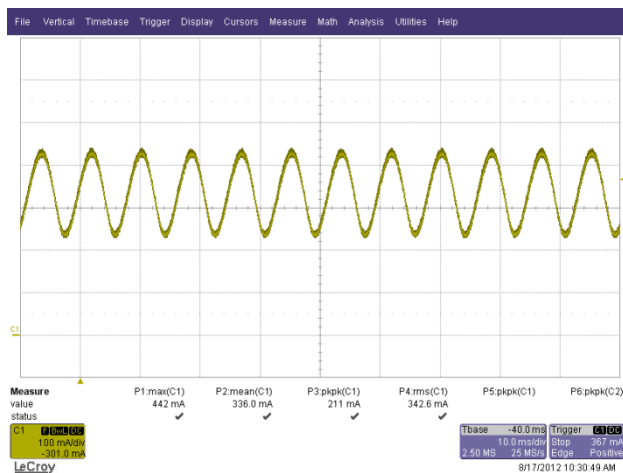

Figure 36 – 90 VAC, 60 Hz Full Load.
I_{OUT}, 100 mA / div., 10 ms / div.

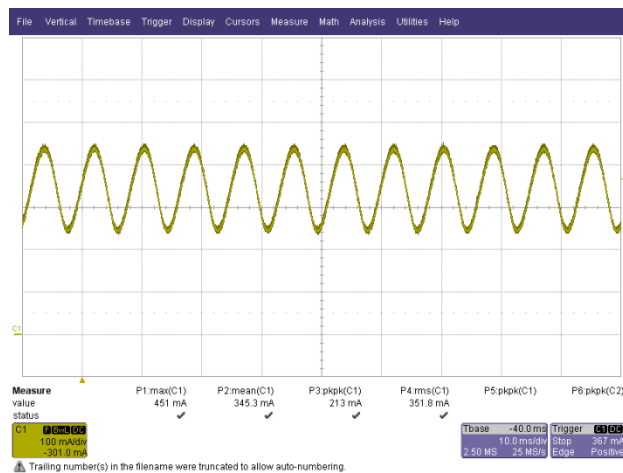

Figure 37 – 100 VAC, 60 Hz Full Load.
I_{OUT}, 100 mA / div., 10 ms / div.

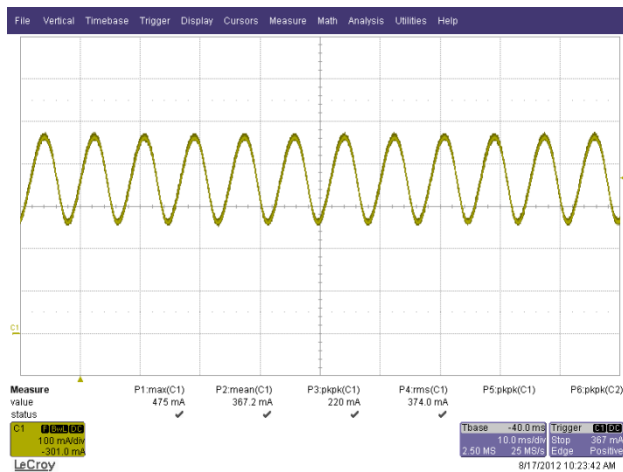

Figure 38 – 120 VAC, 60 Hz Full Load.
I_{OUT}, 100 mA / div., 10 ms / div.

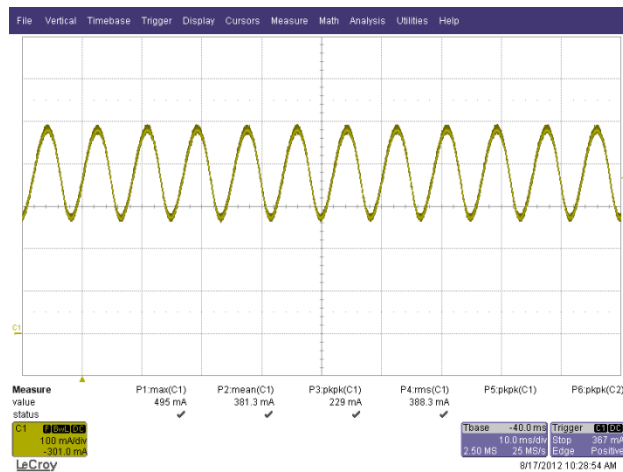

Figure 39 – 132 VAC, 60 Hz Full Load.
I_{OUT}, 100 mA / div., 10 ms / div.



12.3 Input Voltage and Output Current Waveform at Start-Up

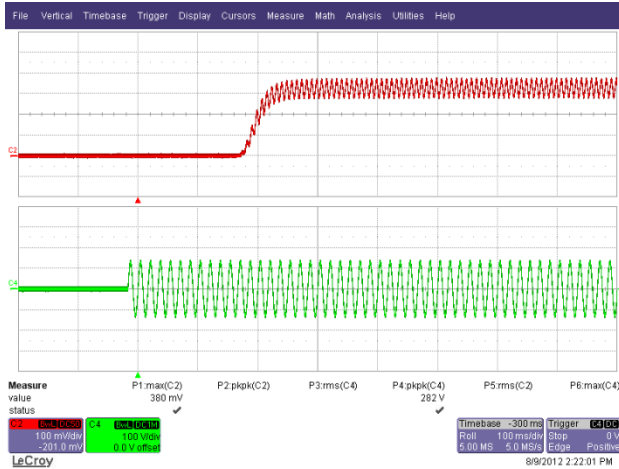

Figure 40 – 90 VAC, 60 Hz.
 Upper: I_{OUT} , 100 mA / div.
 Lower: V_{IN} , 100 V, 100 ms / div.

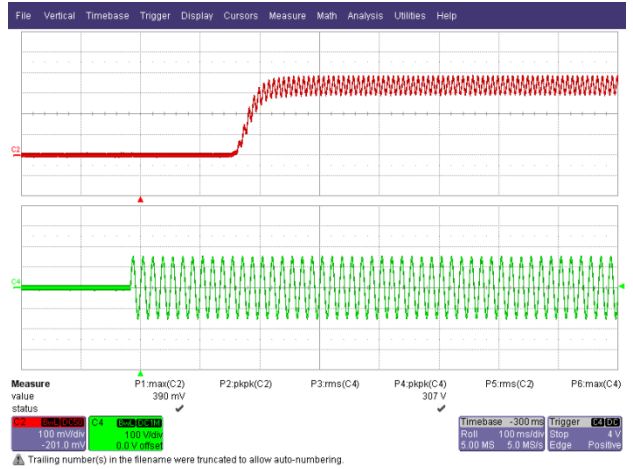

Figure 41 – 100 VAC, 60 Hz.
 Upper: I_{OUT} , 100 mA / div.
 Lower: V_{IN} , 100 V, 100 ms / div.

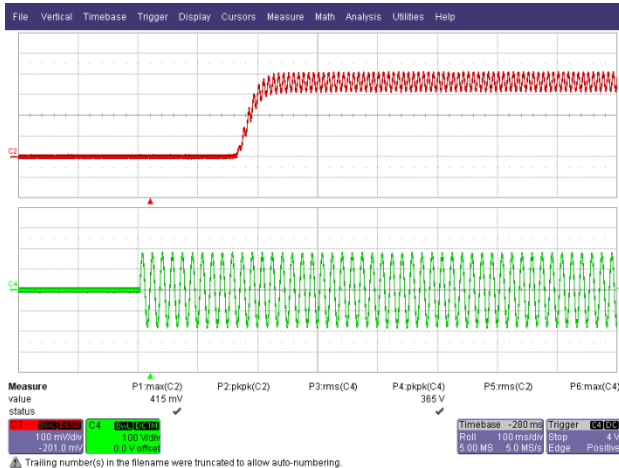

Figure 42 – 120 VAC, 60 Hz.
 Upper: I_{OUT} , 100 mA / div.
 Lower: V_{IN} , 100 V, 100 ms / div.

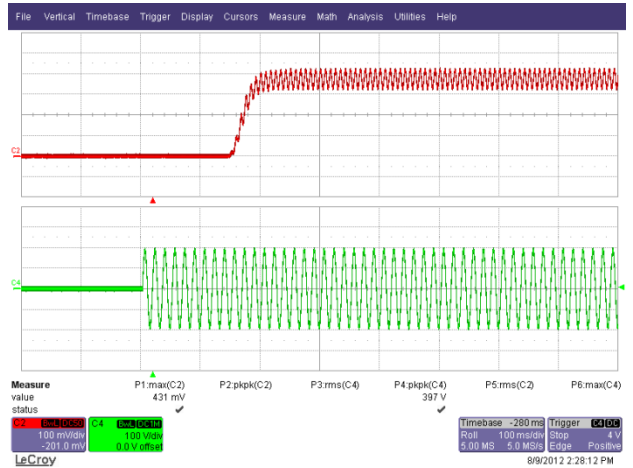

Figure 43 – 132 VAC, 60 Hz.
 Upper: I_{OUT} , 100 mA / div.
 Lower: V_{IN} , 100 V, 100 ms / div.

12.4 Drain Voltage and Current at Normal Operation

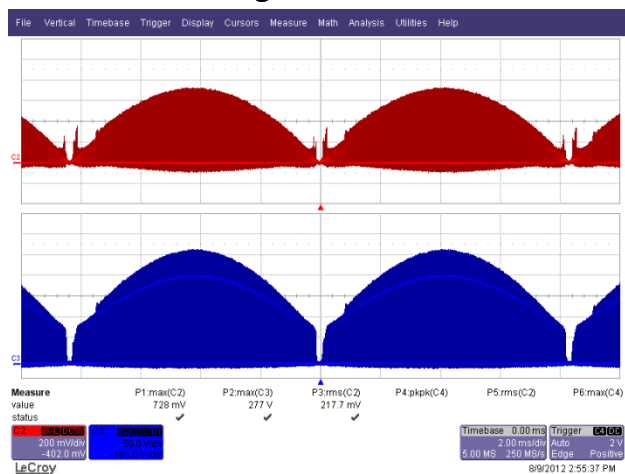

Figure 44 – 90 VAC, 60 Hz.
 Upper: I_{DRAIN} , 0.2 A / div.
 Lower: V_{DRAIN} , 50 V, 2 ms / div.

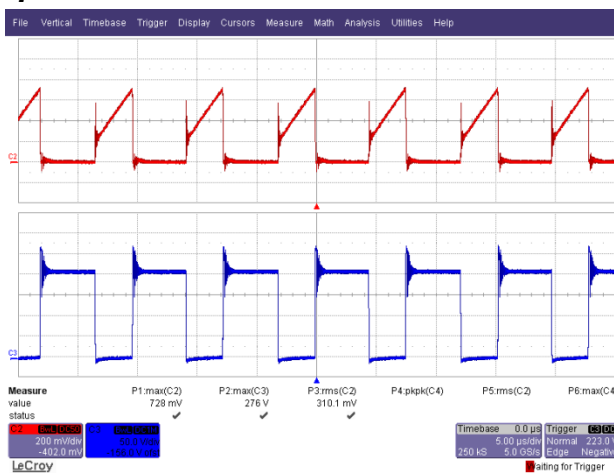

Figure 45 – 90 VAC, 60 Hz.
 Upper: I_{DRAIN} , 0.2 A / div.
 Lower: V_{DRAIN} , 50 V / div., 5 μ s / div.

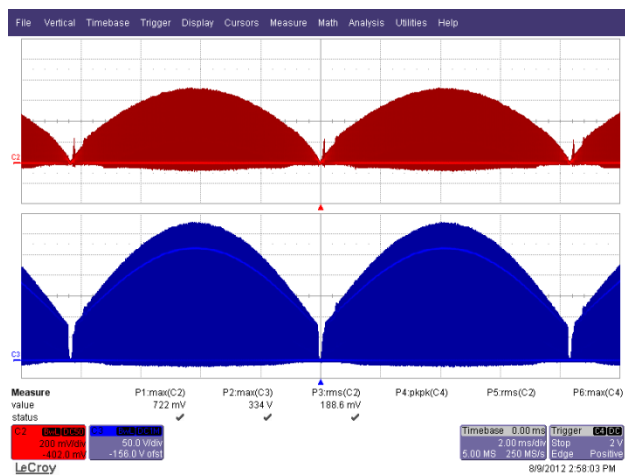

Figure 46 – 132 VAC, 60 Hz.
 Upper: I_{DRAIN} , 0.2 A / div.
 Lower: V_{DRAIN} , 50 V, 2 ms / div.

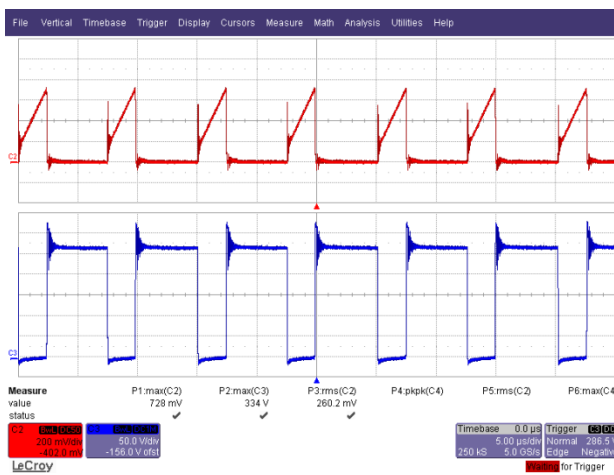

Figure 47 – 132 VAC, 60 Hz.
 Upper: I_{DRAIN} , 0.2 A / div.
 Lower: V_{DRAIN} , 50 V / div., 5 μ s / div.



12.5 Drain Voltage and Current at Start-Up

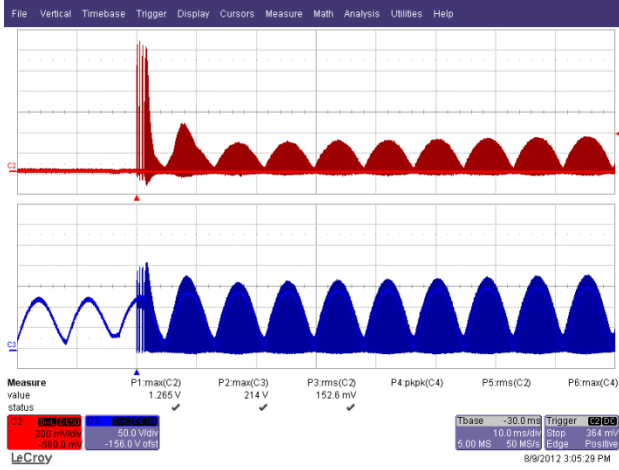

Figure 48 – 90 VAC, 60 Hz Start-up.
 Upper: I_{DRAIN} , 200 mA / div.
 Lower: V_{DRAIN} , 50 V, 5 ms / div.



Figure 49 – 90 VAC, 60 Hz Start-up.
 Upper: I_{DRAIN} , 200 mA / div.
 Lower: V_{DRAIN} , 50 V, 10 μ s / div.

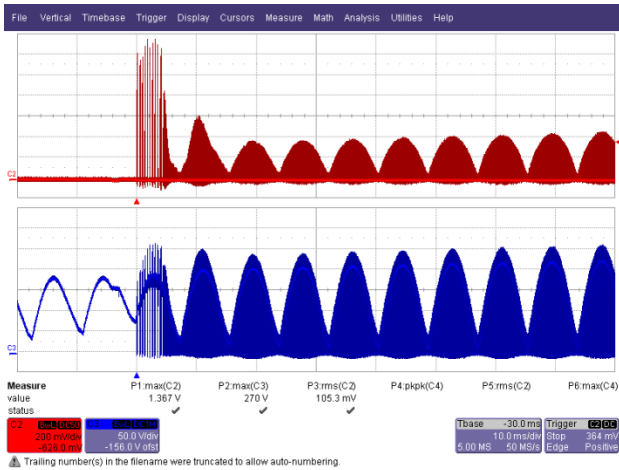

Figure 50 – 132 VAC, 60 Hz Start-up.
 Upper: I_{DRAIN} , 200 mA / div.
 Lower: V_{DRAIN} , 50 V, 5 ms / div.

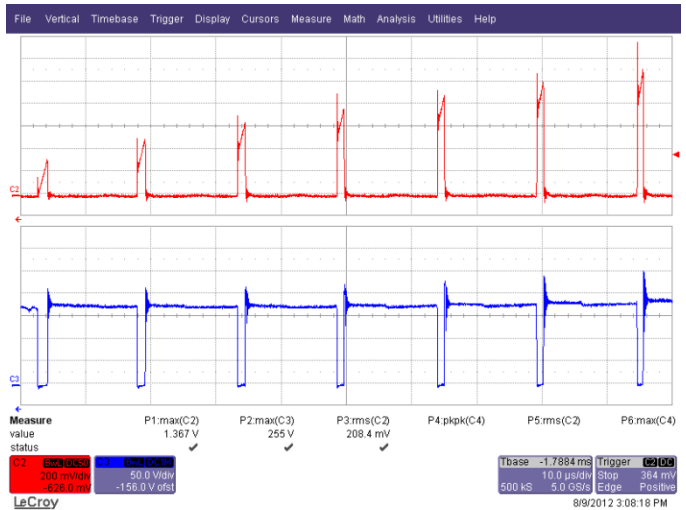

Figure 51 – 132 VAC, 60 Hz Start-up.
 Upper: I_{DRAIN} , 200 mA / div.
 Lower: V_{DRAIN} , 50 V, 10 μ s / div.

12.6 Drain Voltage and Current at Output Short Condition

During output short condition, the I_{FB} current falls below the $I_{FB(AR)}$ threshold and enters the auto-restart condition. During this condition, to minimize power dissipation on the power components, the auto-restart circuit turns the power supply on and off at an auto-restart duty cycle of typically DC_{AR} for as long as the fault condition persists.

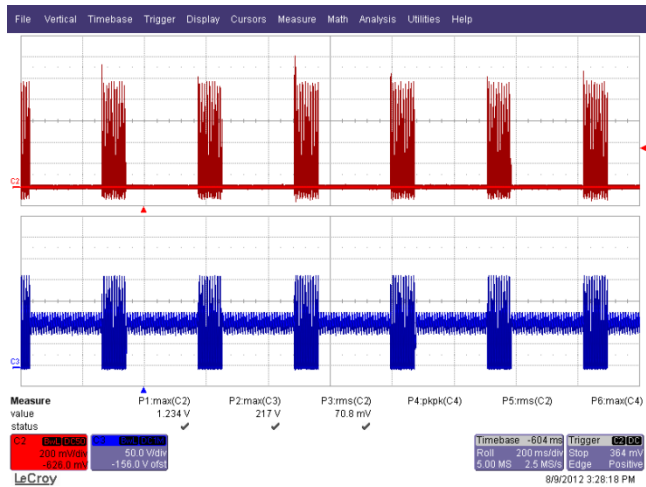

Figure 52 – 90 VAC, 60 Hz Output Short Condition.
 Upper: I_{DRAIN} , 200 mA / div.
 Lower: V_{DRAIN} , 50 V, 200 ms / div.

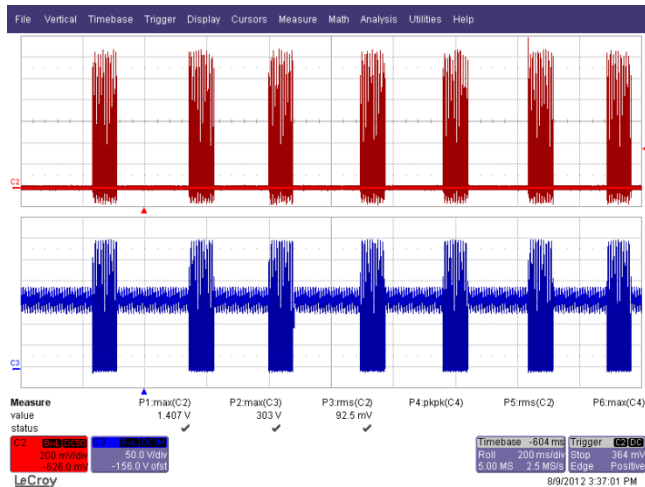

Figure 53 – 132 VAC, 60 Hz Output Short Condition.
 Upper: I_{DRAIN} , 200 mA / div.
 Lower: V_{DRAIN} , 50 V, 200 ms / div.



12.7 Output Diode Voltage and Current at Normal Operation

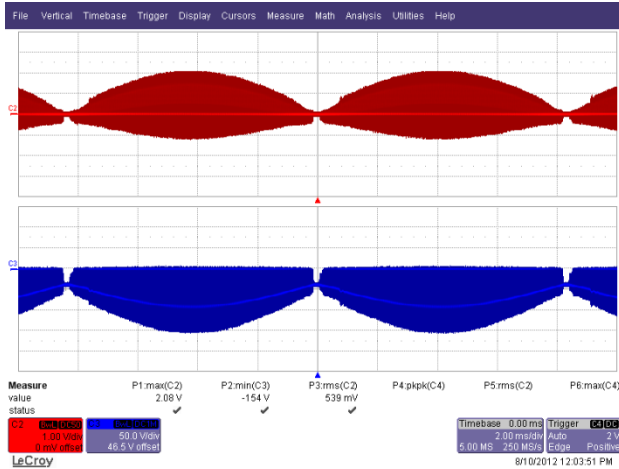

Figure 54 – 90 VAC, 60 Hz.
 Upper: I_{D5} , 1 A / div.
 Lower: V_{D5} , 50 V, 2 ms / div.

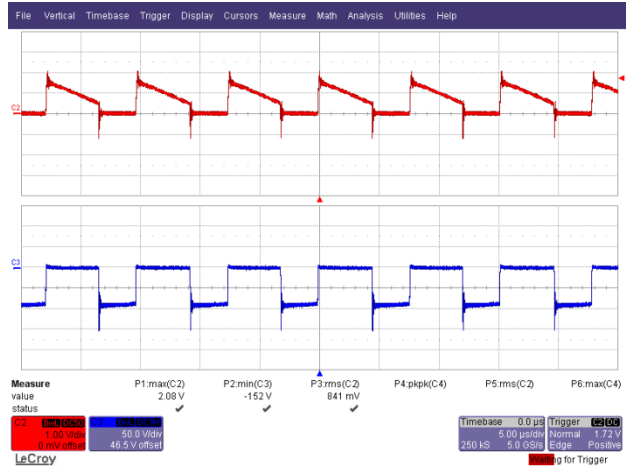

Figure 55 – 90 VAC, 60 Hz.
 Upper: I_{D5} , 0.2 A / div.
 Lower: V_{D5} , 50 V / div., 5 μ s / div.

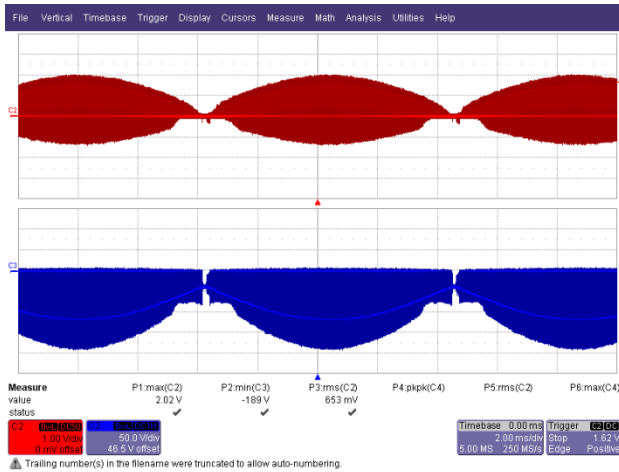

Figure 56 – 132 VAC, 60 Hz.
 Upper: I_{D5} , 1 A / div.
 Lower: V_{D5} , 50 V, 2 ms / div.

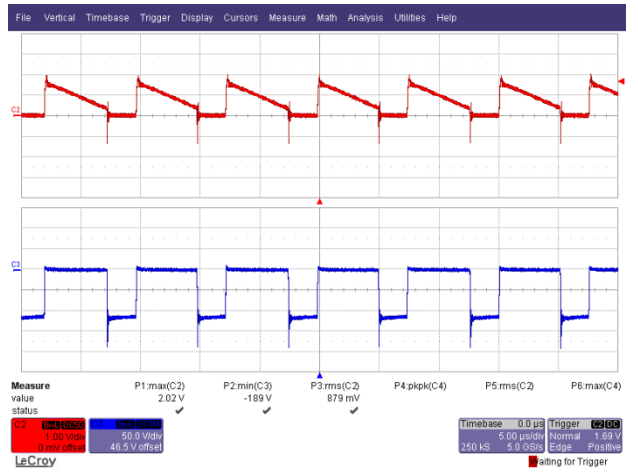

Figure 57 – 132 VAC, 60 Hz.
 Upper: I_{D5} , 0.2 A / div.
 Lower: V_{D5} , 50 V / div., 5 μ s / div.

12.8 Output Diode Voltage and Current at Start-up and Output Short Condition

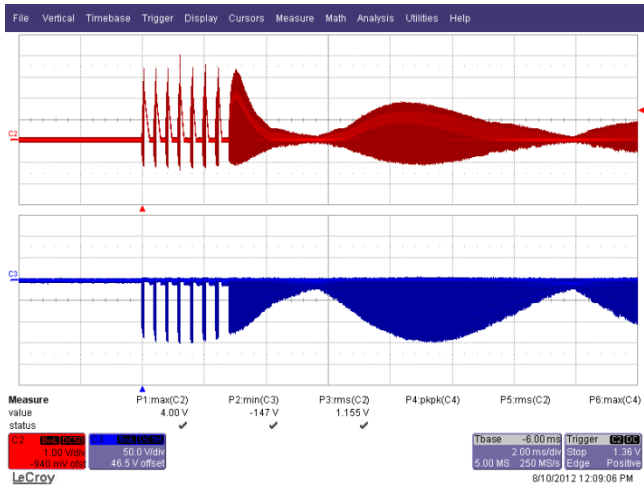

Figure 58 – 132 VAC, 60 Hz Start-up Condition.
Upper: I_{D5} , 1 A / div.
Lower: V_{D5} , 50 V, 2 ms / div.

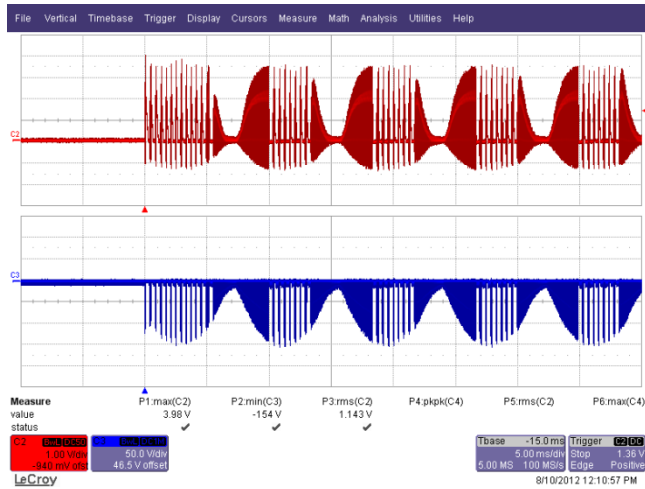

Figure 59 – 132 VAC, 60 Hz Output Short Condition.
Upper: I_{D5} , 200 mA / div.
Lower: V_{D5} , 50 V, 5 ms / div.

12.9 Output Voltage during Open Load Condition

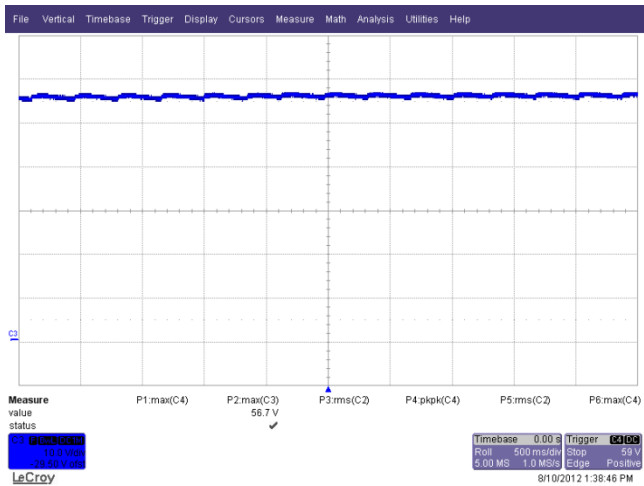

Figure 60 – 90 VAC, 60 Hz Open Load Condition.
 V_{OUT} , 10 V / div.

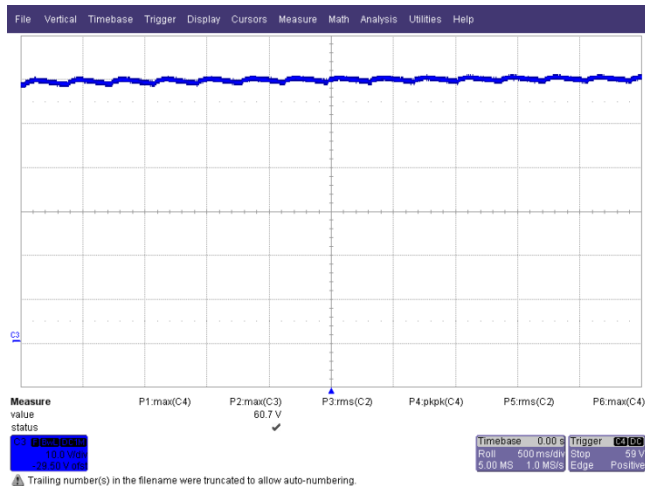

Figure 61 – 132 VAC, 60 Hz Open Load Condition.
 V_{OUT} , 10 V / div.



13 Dimming Waveforms

13.1 Input Voltage and Input Current Waveforms

Input: 120 VAC, 60 Hz Utility Line

Output: 34 V LED Load

Dimmer: LUTRON GL-600WH

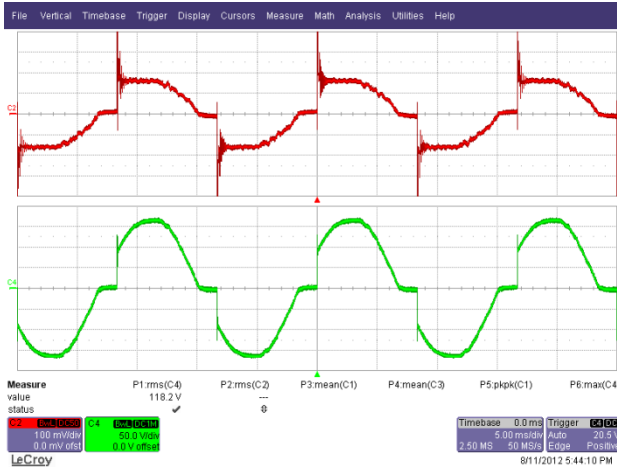

Figure 62 – 147° Conduction Angle.
Upper: I_{IN} , 100 mA / div.
Lower: V_{IN} , 50 V, 5 ms / div.

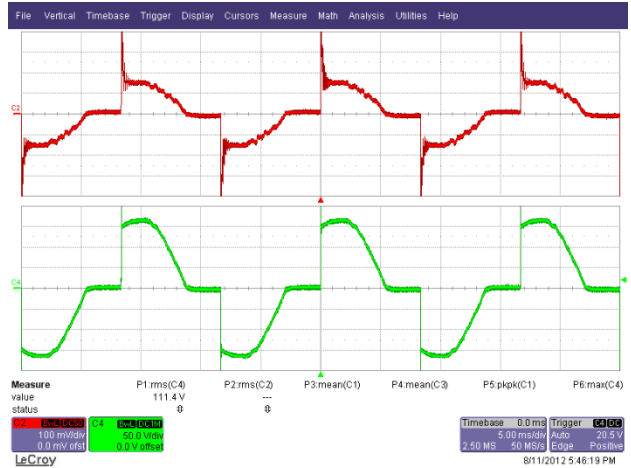

Figure 63 – 120° Conduction Angle.
Upper: I_{IN} , 100 mA / div.
Lower: V_{IN} , 50 V, 5 ms / div.

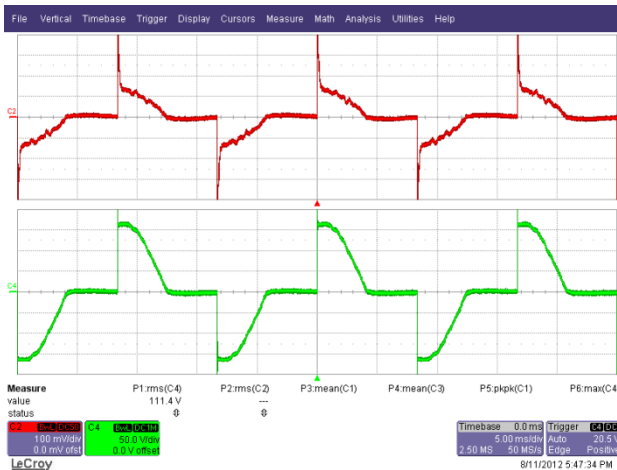

Figure 64 – 90° Conduction Angle.
Upper: I_{IN} , 100 mA / div.
Lower: V_{IN} , 50 V, 5 ms / div.

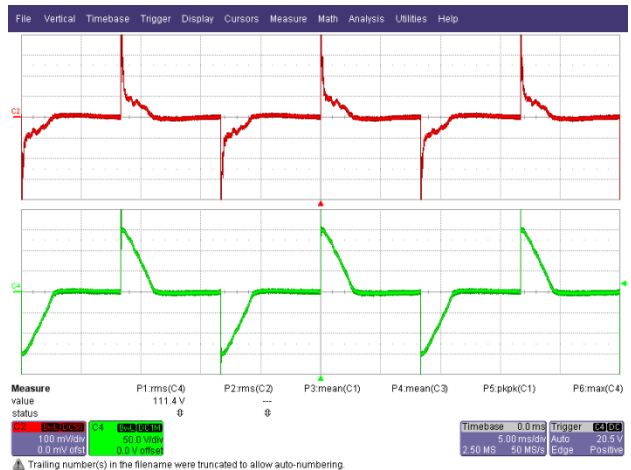

Figure 65 – 54° Conduction Angle.
Upper: I_{IN} , 100 mA / div.
Lower: V_{IN} , 50 V, 5 ms / div.



13.2 Output Current Waveforms

Input: 120 VAC, 60 Hz Utility Line
 Output: 34 V LED Load
 Dimmer: LUTRON GL-600WH

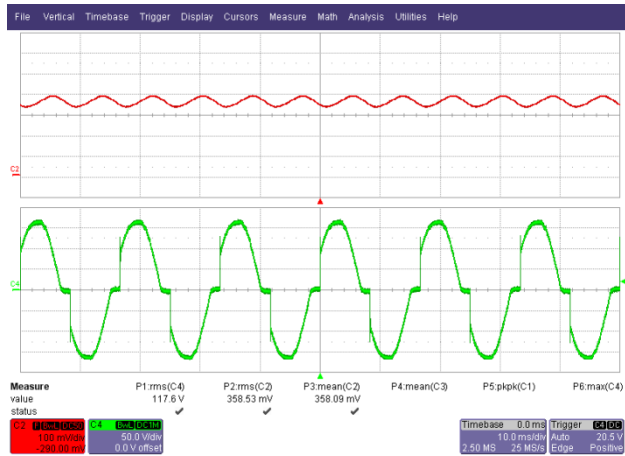

Figure 66 – 147° Conduction Angle.
 Upper: I_{OUT} , 100 mA / div.
 Lower: V_{IN} , 50 V, 10 ms / div.

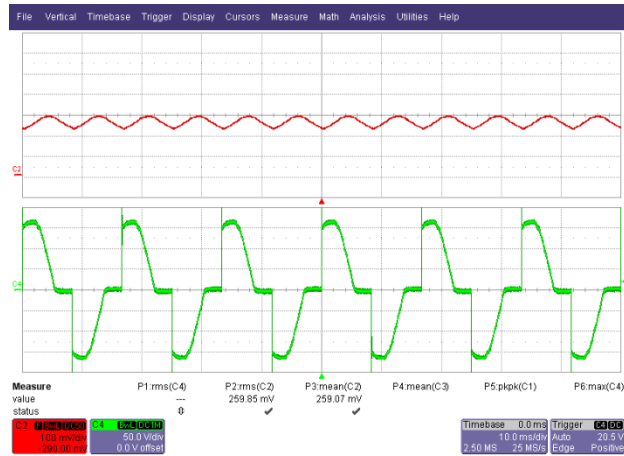

Figure 67 – 120° Conduction Angle.
 Upper: I_{OUT} , 100 mA / div.
 Lower: V_{IN} , 100 V, 10 ms / div.

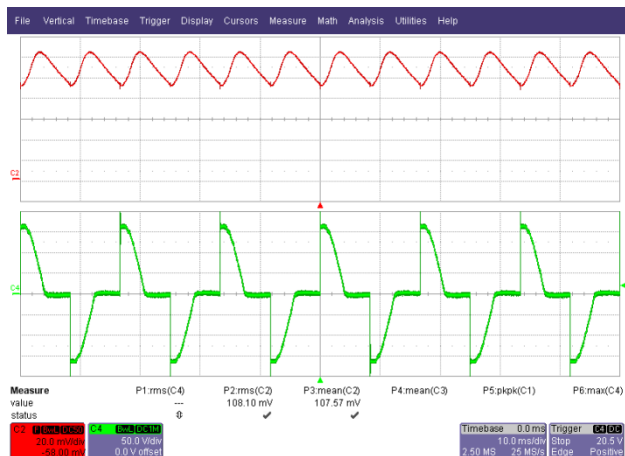

Figure 68 – 90° Conduction Angle.
 Upper: I_{OUT} , 20 mA / div.
 Lower: V_{IN} , 50 V, 10 ms / div.

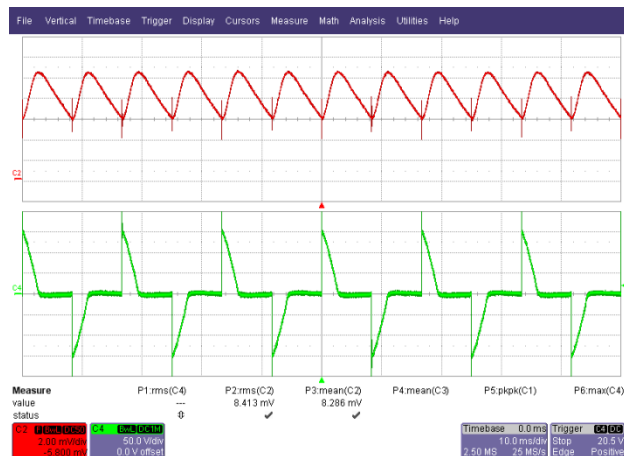

Figure 69 – 54° Conduction Angle.
 Upper: I_{OUT} , 2 mA / div.
 Lower: V_{IN} , 50 V, 10 ms / div.



13.3 Input Voltage and Output Current Waveform at 10% and 1% I_{OUT} Start-Up

Input: ~120 VAC, 60 Hz Utility Line
 Dimmer: LEVITON R62-06633

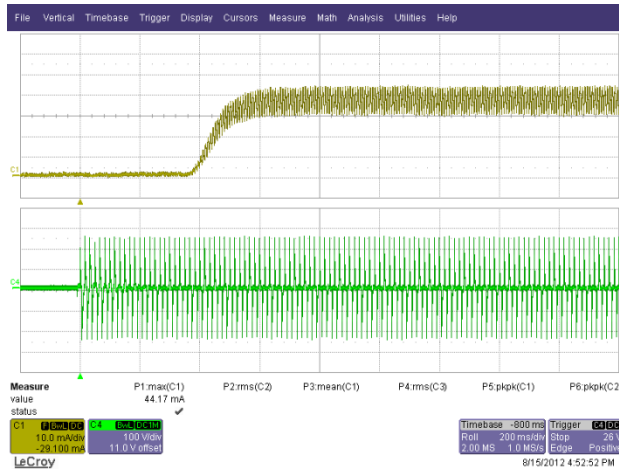

Figure 70 – 120 VAC, 60 Hz.
 Upper: I_{OUT} , 10 mA / div.
 Lower: V_{IN} , 100 V, 200 ms / div.

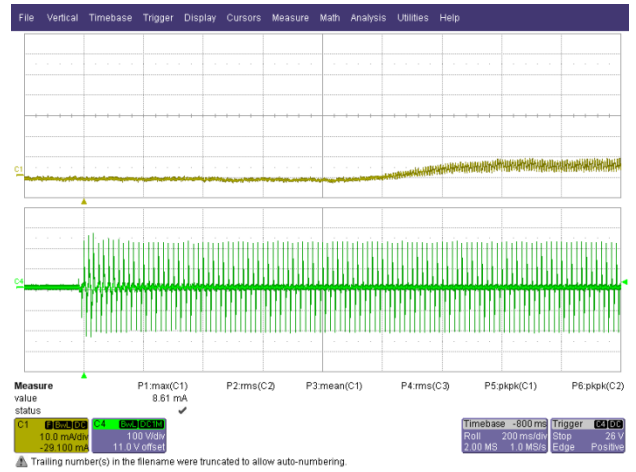

Figure 71 – 120 VAC, 60 Hz.
 Upper: I_{OUT} , 5 mA / div.
 Lower: V_{IN} , 100 V, 200 ms / div.

14 Conducted EMI

14.1 Test Set-Up

The unit was tested using an LED load ($\sim 34\text{ V } V_{\text{OUT}}$) from a commercially available 6" LED down light with input voltage of 120 VAC, 60 Hz at room temperature and with the case connected to earth.



Figure 72 – EMI Test Set-up.



14.2 Test Result

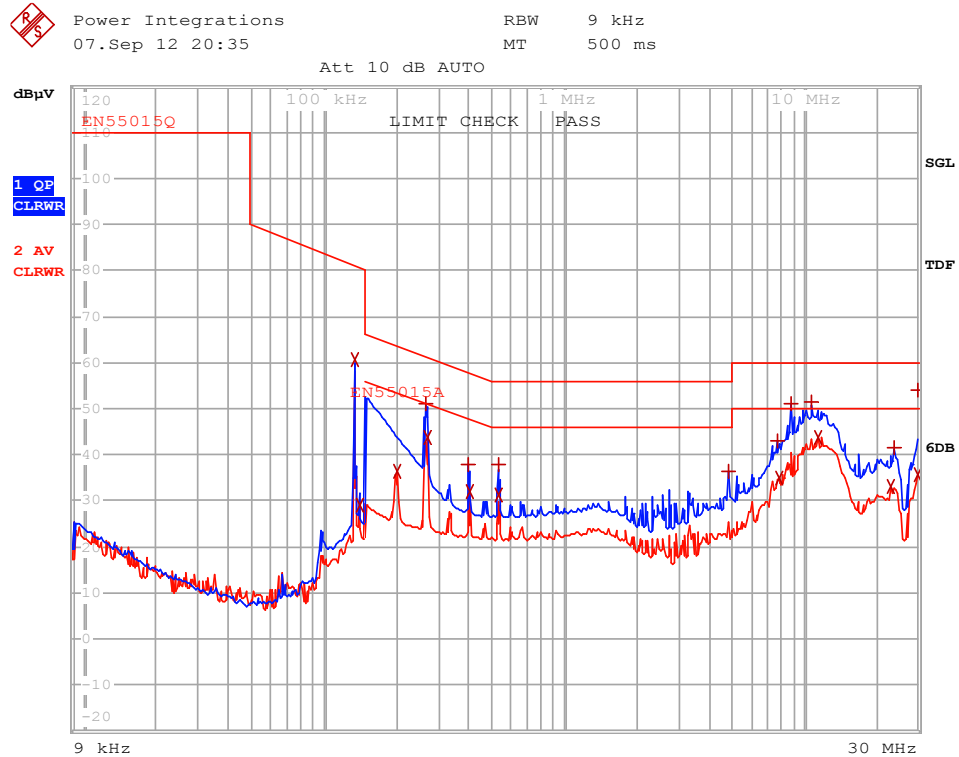

EDIT PEAK LIST (Final Measurement Results)

TRACE	FREQUENCY	LEVEL dBµV	DELTA LIMIT dB
Trace1:	EN55015Q		
Trace2:	EN55015A		
Trace3:	---		
TRACE	FREQUENCY	LEVEL dBµV	DELTA LIMIT dB
2 Average	133.454986145 kHz	60.71 L1 gnd	
2 Average	140.262531674 kHz	29.02 L1 gnd	
2 Average	200.175581485 kHz	36.35 L1 gnd	-17.24
1 Quasi Peak	264.49018761 kHz	51.05 L1 gnd	-10.23
2 Average	267.135089486 kHz	43.93 L1 gnd	-7.27
1 Quasi Peak	397.727746704 kHz	38.01 L1 gnd	-19.88
2 Average	401.705024172 kHz	31.94 L1 gnd	-15.87
1 Quasi Peak	530.769219795 kHz	37.78 N gnd	-18.21
2 Average	530.769219795 kHz	31.33 N gnd	-14.66
1 Quasi Peak	4.83337742374 MHz	36.45 N gnd	-19.54
1 Quasi Peak	7.71534368894 MHz	42.95 L1 gnd	-17.04
2 Average	7.94912631806 MHz	35.04 N gnd	-14.95
1 Quasi Peak	8.86858861671 MHz	51.10 L1 gnd	-8.89
1 Quasi Peak	10.7142212856 MHz	51.52 N gnd	-8.47
2 Average	11.3733617927 MHz	43.88 L1 gnd	-6.11
2 Average	22.8236458211 MHz	32.93 L1 gnd	-17.06
1 Quasi Peak	23.7503773643 MHz	41.40 N gnd	-18.59
1 Quasi Peak	30 MHz	53.94 L1 gnd	-6.05
2 Average	30 MHz	35.85 L1 gnd	-14.14

Figure 73 – Conducted EMI, 34 V LED Load, 120 VAC, 60 Hz, and EN55015 B Limits.



15 Line Surge

The unit was subjected to ± 2500 V 100 kHz ring wave and ± 500 V differential surge at 120 VAC using 10 strikes at each condition. A test failure was defined as a non-recoverable interruption of output requiring supply repair or recycling of input voltage.

Level (V)	Input Voltage (VAC)	Injection Location	Injection Phase (°)	Type	Test Result (Pass/Fail)
+2500	120	L1, L2	0	100 kHz Ring Wave (500 A)	Pass
-2500	120	L1, L2	0	100 kHz Ring Wave (500 A)	Pass
+2500	120	L1, L2	90	100 kHz Ring Wave (500 A)	Pass
-2500	120	L1, L2	90	100 kHz Ring Wave (500 A)	Pass

Level (V)	Input Voltage (VAC)	Injection Location	Injection Phase (°)	Type	Test Result (Pass/Fail)
+500	120	L1, L2	0	Surge (2Ω)	Pass
-500	120	L1, L2	0	Surge (2Ω)	Pass
+500	120	L1, L2	90	Surge (2Ω)	Pass
-500	120	L1, L2	90	Surge (2Ω)	Pass

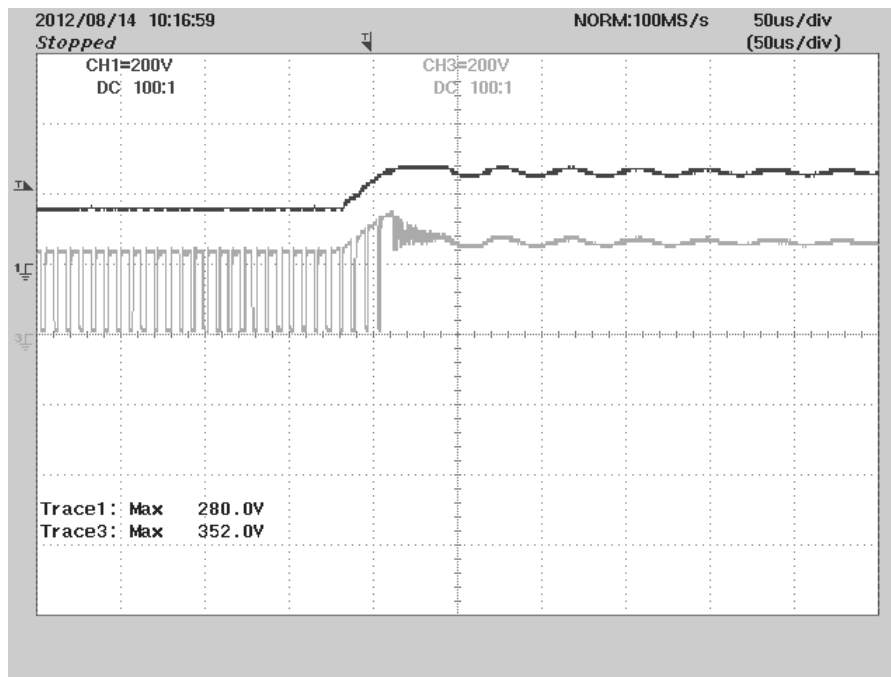

Figure 74 – 500 V Differential Line Surge at 90° Injection Phase.
 CH1: U1 VC5 (<400 V); CH3: VDS_{U1}



16 No Active Pre-Load Option

Without the active pre-load circuit connected on the secondary output the natural high efficiency performance of LYTSwitch is achieved. Although minimum dim current maybe higher for TRIAC dimmers with a high minimum conduction angle (>40°), high dim ratio can be achieved with most dimmers that were designed properly (see section 16.9-10 for dimming performance).

16.1 Schematic

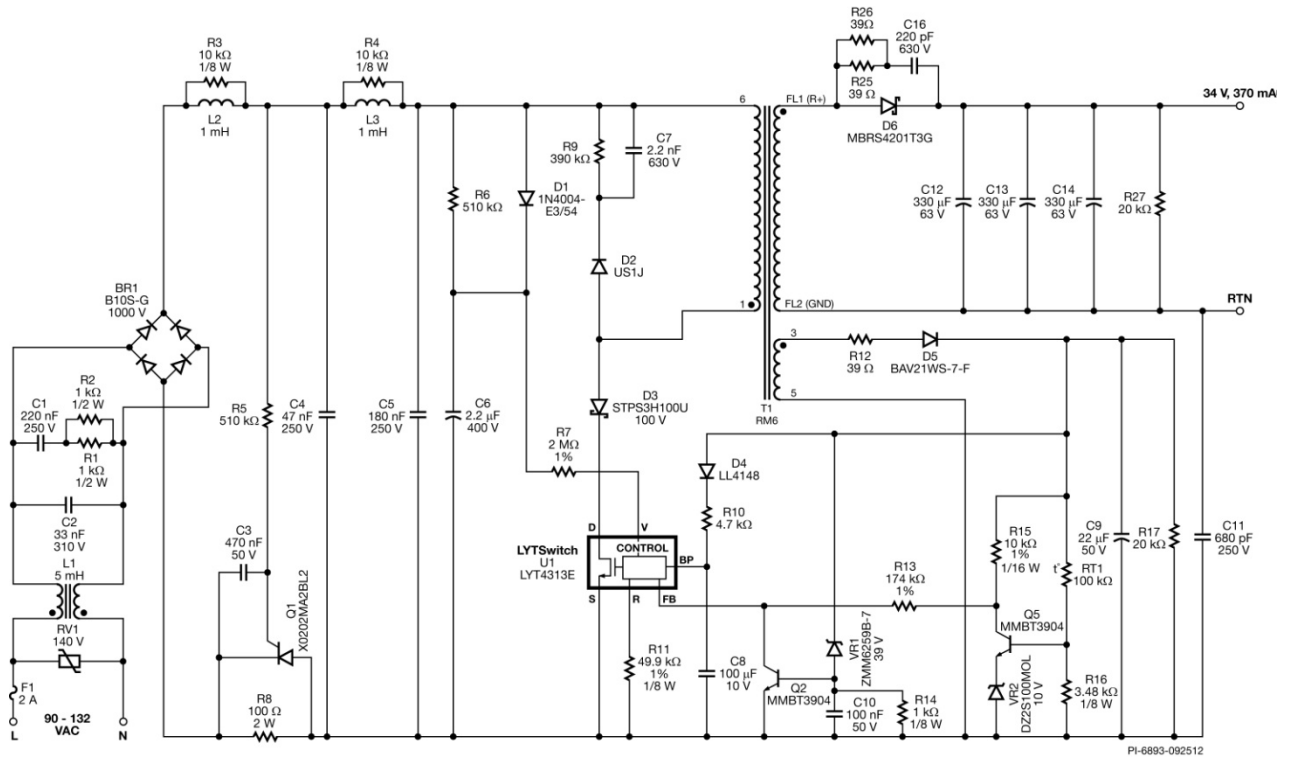

Figure 75 – No Active Pre-Load Schematic.

16.2 Bill of Materials

Item	Qty	Ref Des	Description	Mfg Part Number	Mfg
1	1	BR1	1000 V, 0.8 A, Bridge Rectifier, SMD, MBS-1, 4-SOIC	B10S-G	Comchip
2	1	C1	220 nF, 250 V, Film	ECQ-E2224KF	Panasonic
3	1	C2	33 nF, 310 VAC, Polyester Film, X2	BFC233920333	Vishay
4	1	C3	470 nF, 50 V, Ceramic, Y5G, 0603	C1608Y5V1H474Z	TDK
5	1	C4	47 nF, 250 V, Film	ECQ-E2473KB	Panasonic
6	1	C5	180 nF, 250 V, Film	ECQ-E2184KB	Panasonic
7	1	C6	2.2 μ F, 400 V, Electrolytic, (8 x 11.5)	SMG400VB2R2M8X11LL	Nippon Chemi-Con
8	1	C7	2.2 nF, 630 V, Ceramic, X7R, 1206	ECJ-3FBJ222K	Panasonic
9	1	C8	100 μ F, 10 V, Ceramic, X5R, 1210	C3216X5R1A107M-T	TDK
10	1	C9	22 μ F, 50 V, Electrolytic, Low ESR, 900 m Ω , (5 x 11.5)	ELXZ500ELL220MEB5D	Nippon Chemi-Con
11	1	C10	100 nF, 50 V, Ceramic, X7R, 0805	CC0805KRX7R9BB104	Yageo
12	1	C11	680 pF, Ceramic, Y1	440LT68-R	Vishay
13	3	C12 C13 C14	330 μ F, 63, Electrolytic, Low ESR, 85 m Ω , (12.5 x 20)	ELXZ630ELL331MK20S	Nippon Chemi-Con
14	1	C16	220 pF, 630 V, Ceramic, NPO, 1206	C3216C0G2J221J	TDK
15	1	D1	400 V, 1 A, Rectifier, DO-41	1N4004-E3/54	Vishay
16	1	D2	Diode Ultrafast, SW 600 V, 1 A, SMA	US1J-13-F	Diodes, Inc.
17	1	D3	100 V, 3 A, Schottky, DO-214AA	STPS3H100U	ST Micro
18	1	D4	75 V, 0.15 A, Fast Switching, 4 ns, MELF	LL4148-13	Diodes, Inc.
19	1	D5	250 V, 0.2 A, Fast Switching, 50 ns, SOD-323	BAV21WS-7-F	Diodes, Inc.
20	1	D6	200 V, 4 A, Schottky, SMC, DO-214AB	MBRS4201T3G	On Semi
21	1	F1	2 A, 250 V, Slow, Long Time Lag,RST	RST 2	Belfuse
22	1	L1	5 mH, 0.3 A, Common Mode Choke	SU9V-03050	Tokin
23	2	L2 L3	1 mH, 0.23 A, Ferrite Core	CTSCH875DF-102K	CT Parts
24	1	Q1	SCR, 600 V, 1.25 A, TO-92	X0202MA 2BL2	ST Micro
25	2	Q2 Q5	NPN, Small Signal BJT, 40 V, 0.2 A, SOT-23	MMBT3904LT1G	On Semi
26	2	R1 R2	1 k Ω , 5%, 1/2 W, Thick Film, 1210	ERJ-14YJ102U	Panasonic
27	2	R3 R4	10 k Ω , 5%, 1/8 W, Thick Film, 0805	ERJ-6GEYJ103V	Panasonic
28	1	R5	510 k Ω , 5%, 1/4 W, Thick Film, 1206	ERJ-8GEYJ514V	Panasonic
29	1	R6	510 k Ω , 5%, 1/4 W, Carbon Film	CFR-25JB-510K	Yageo
30	1	R7	2.00 M Ω , 1%, 1/4 W, Thick Film, 1206	ERJ-8ENF2004V	Panasonic
31	1	R8	100 Ω , 5%, 2 W, Metal Oxide	RSMF2JT100R	Stackpole
32	1	R9	390 k Ω , 5%, 1/4 W, Thick Film, 1206	ERJ-8GEYJ394V	Panasonic
33	1	R10	4.7 k Ω , 5%, 1/4 W, Thick Film, 1206	ERJ-8GEYJ472V	Panasonic
34	1	R11	49.9 k Ω , 1%, 1/8 W, Thick Film, 0805	ERJ-6ENF4992V	Panasonic
35	3	R12 R25 R26	39 Ω , 5%, 1/4 W, Thick Film, 1206	ERJ-8GEYJ390V	Panasonic
36	1	R13	174 k Ω , 1%, 1/4 W, Thick Film, 1206	ERJ-8ENF1743V	Panasonic
37	1	R14	1 k Ω , 5%, 1/8 W, Thick Film, 0805	ERJ-6GEYJ102V	Panasonic
38	1	R15	10 k Ω , 1%, 1/16 W, Thick Film, 0603	ERJ-3EKF1002V	Panasonic
39	1	R16	3.48 k Ω , 1%, 1/8 W, Thick Film, 0805	ERJ-6ENF3481V	Panasonic
40	2	R17 R27	20 k Ω , 5%, 1/4 W, Thick Film, 1206	ERJ-8GEYJ203V	Panasonic
41	1	RT1	NTC Thermistor, 100 k Ohms, 0.00014 A	NTSA0WF104EE1B0	Murata
42	1	RV1	140 V, 12 J, 7 mm, RADIAL	V140LA2P	Littlefuse
43	1	T1	Bobbin, RM6, Vertical, 6 pins	B65808-N1006-D1	Epcos
44	1	U1	LYTswitch, eSIP-7C	LYT4313E	Power Integrations
45	1	VR1	39 V, 5%, 500 mW, DO-213AA (MELF)	ZMM5259B-7	Diodes, Inc.
46	1	VR2	10 V, 5%, 150 mW, SSMINI-2	DZ2S100MOL	Panasonic



16.3 Efficiency

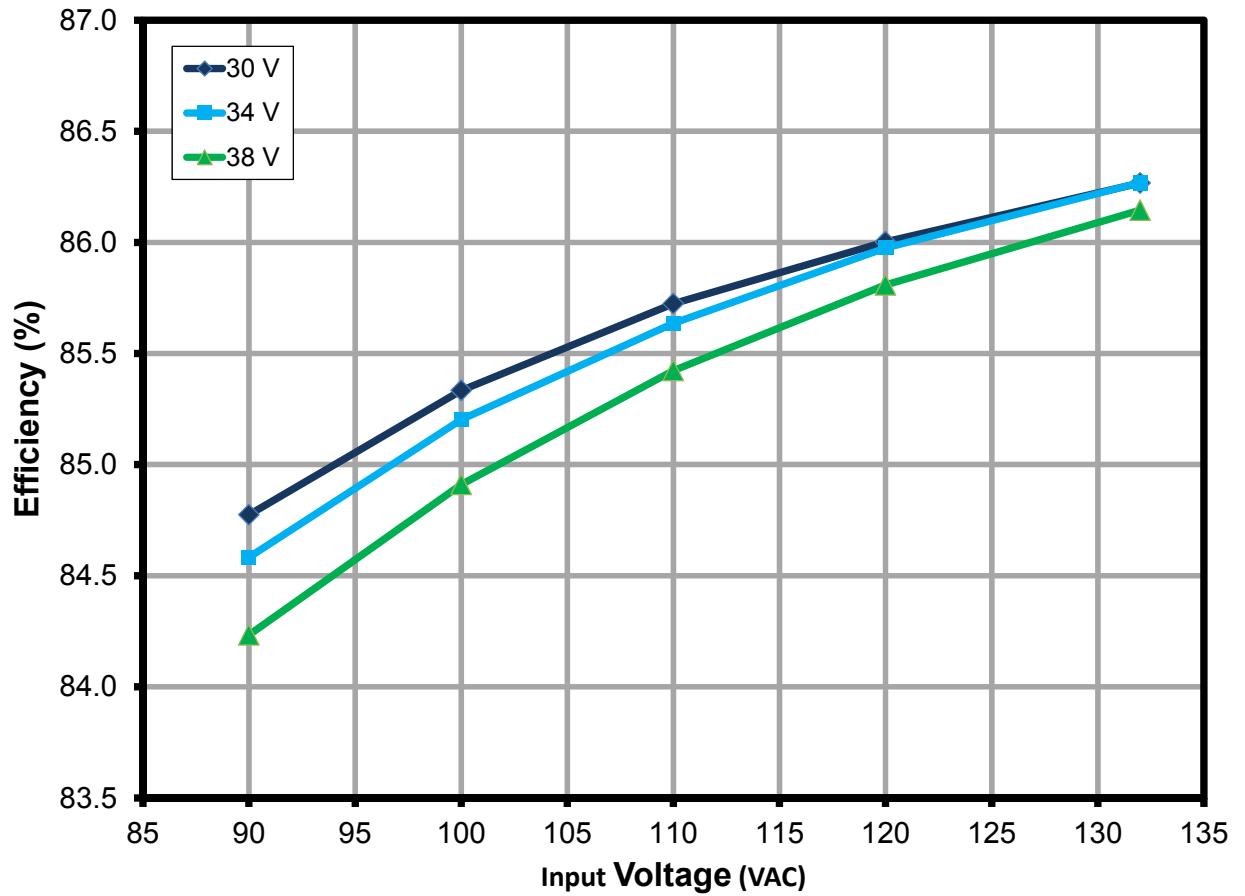

Figure 76 – Efficiency vs. Line and Load.



16.4 Line and Load Regulation

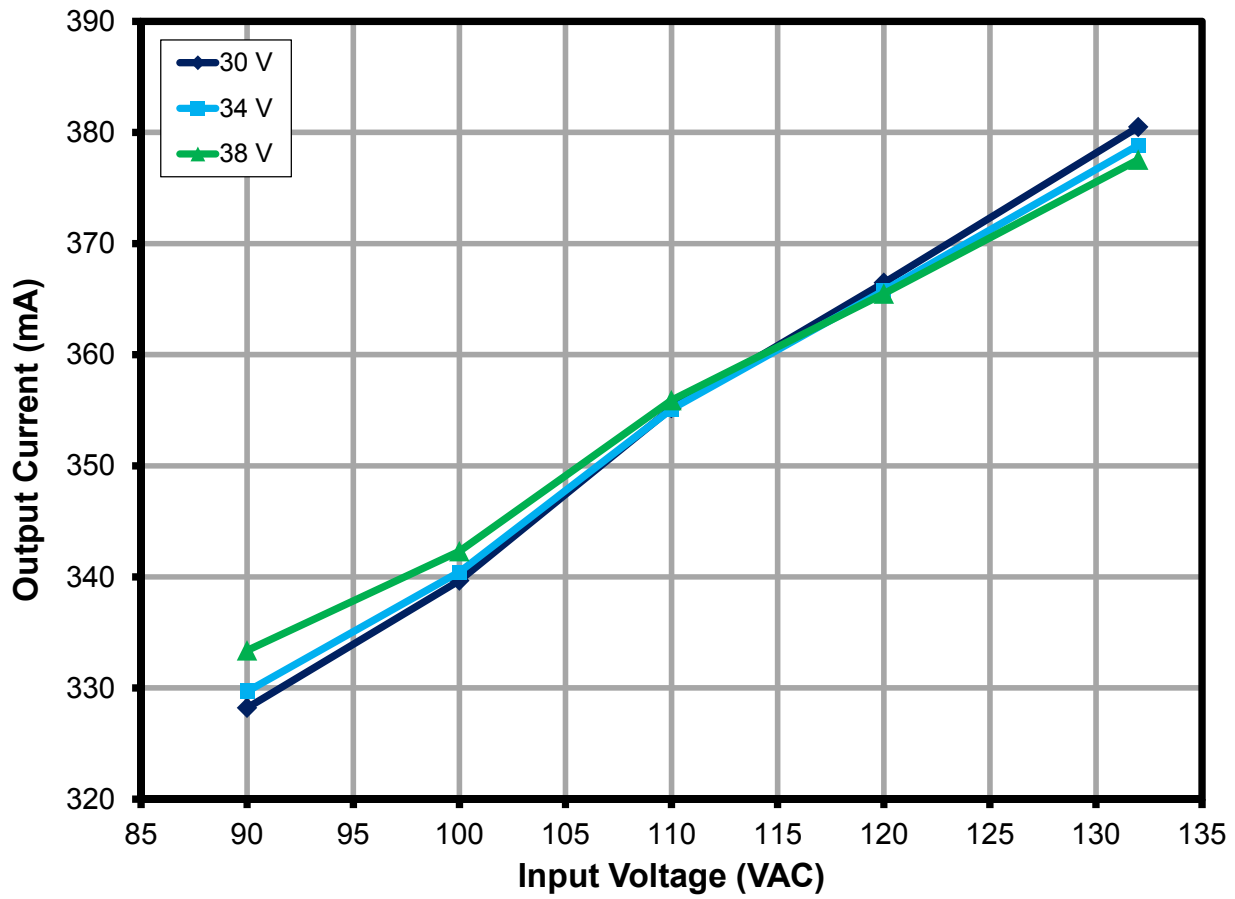

Figure 77 – Regulation vs. Line and Load.



16.5 Power Factor

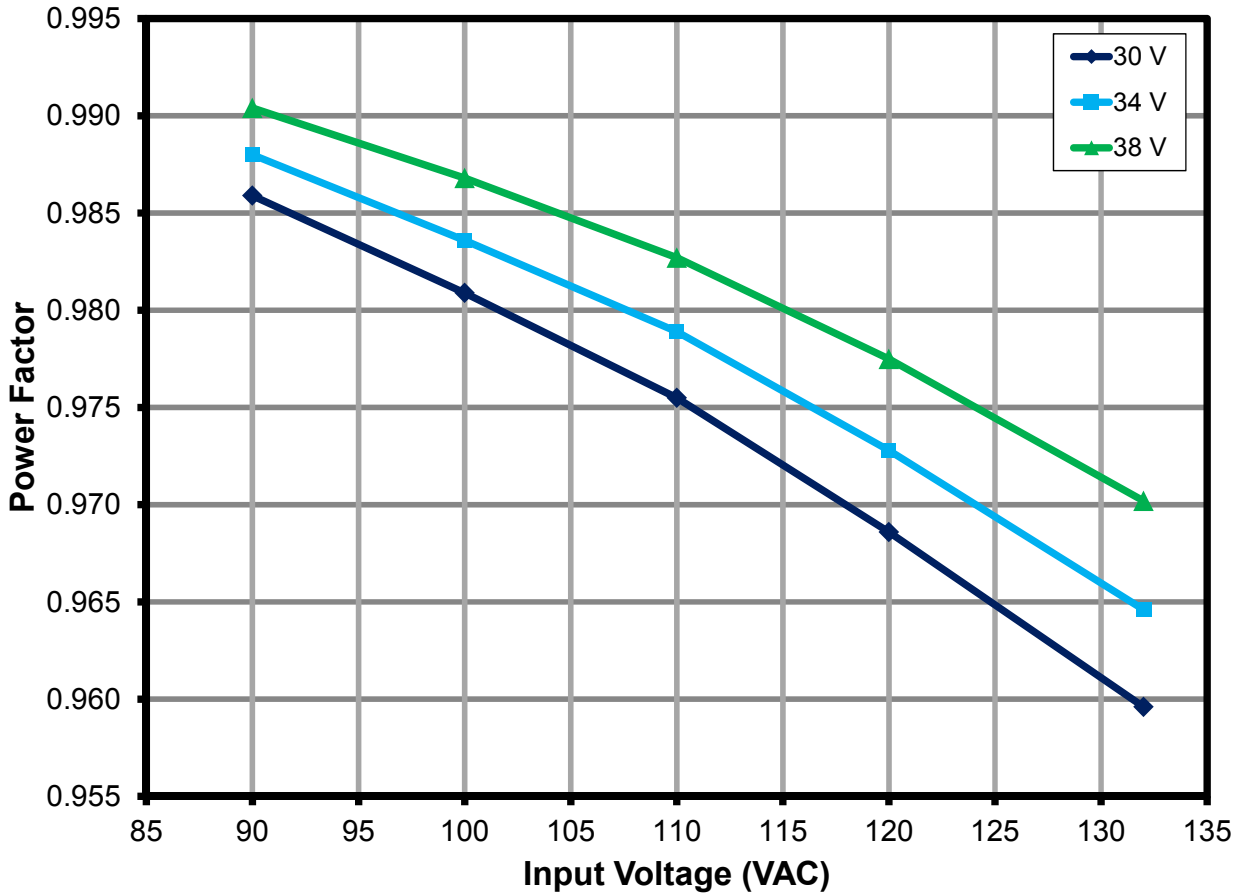

Figure 78 – Power Factor vs. Line and Load.



16.6 A-THD

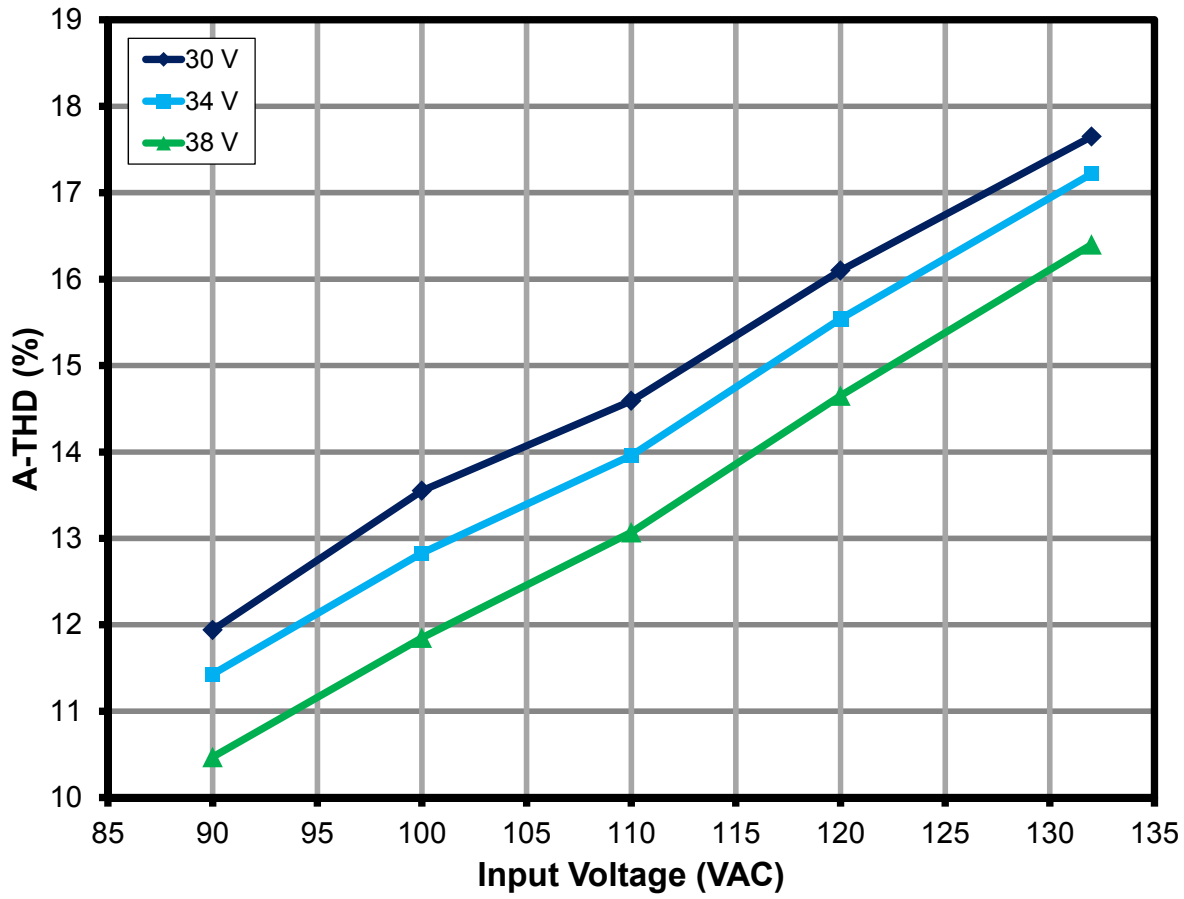

Figure 79 – A-THD vs. Line and Load.



16.7 Harmonic Currents

The design met the limits for Class C equipment for an active input power of <25 W. In this case IEC61000-3-2 specifies that harmonic currents shall not exceed the limits of Class D equipment². Therefore the limits shown in the charts below are Class D limits which must not be exceeded to meet Class C compliance.

16.7.1 30 V LED Load

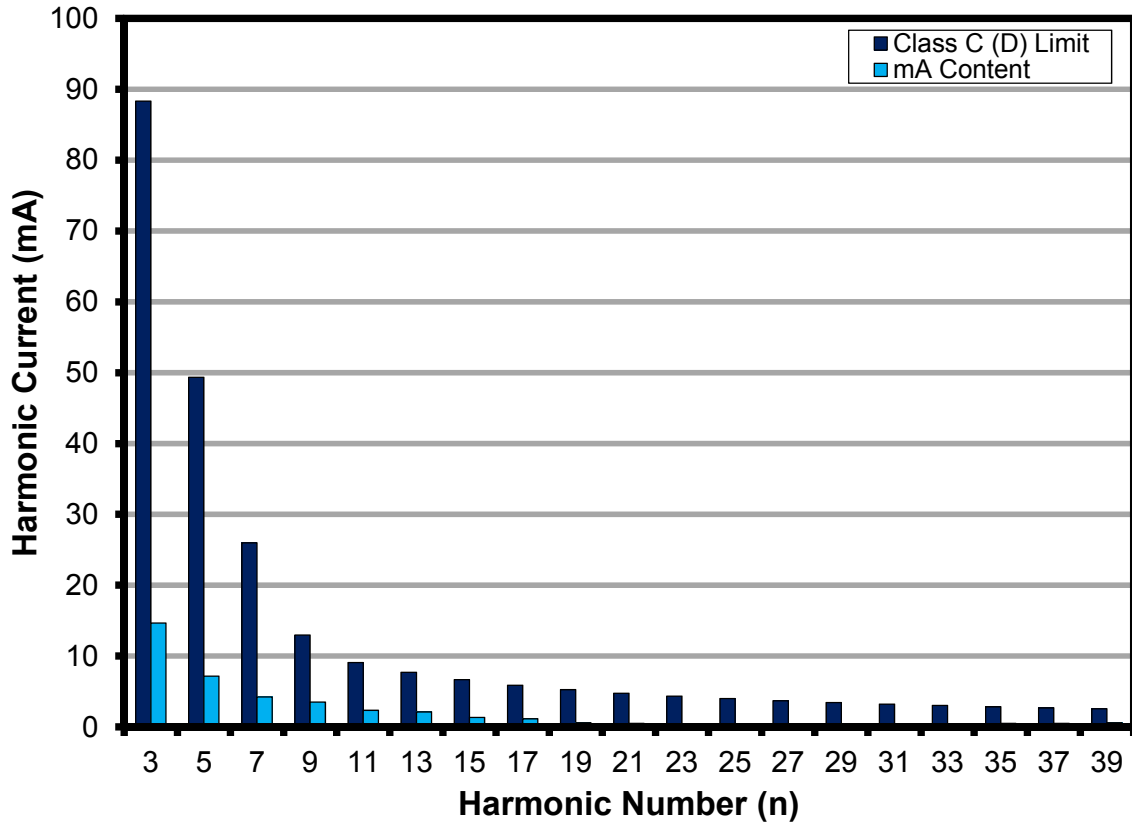

Figure 80 – 30 V LED Load Input Current Harmonics case (IEC61000-3-2) at 120 VAC, 60 Hz.

² IEC6000-3-2 Section 7.3, table 2, column 2.



16.7.3 34 V LED Load

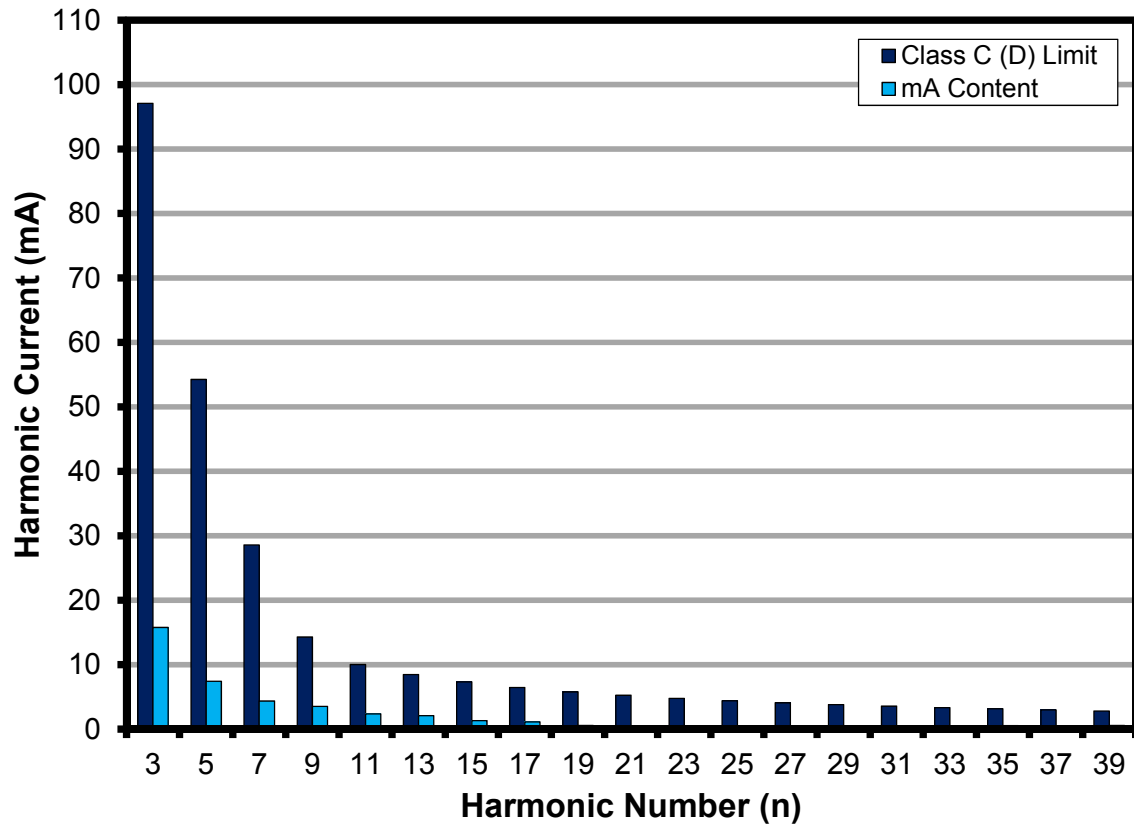

Figure 81 – 34 V LED Load Input Current Harmonics (IEC61000-3-2) at 120 VAC, 60 Hz.



16.7.4 38 V LED Load

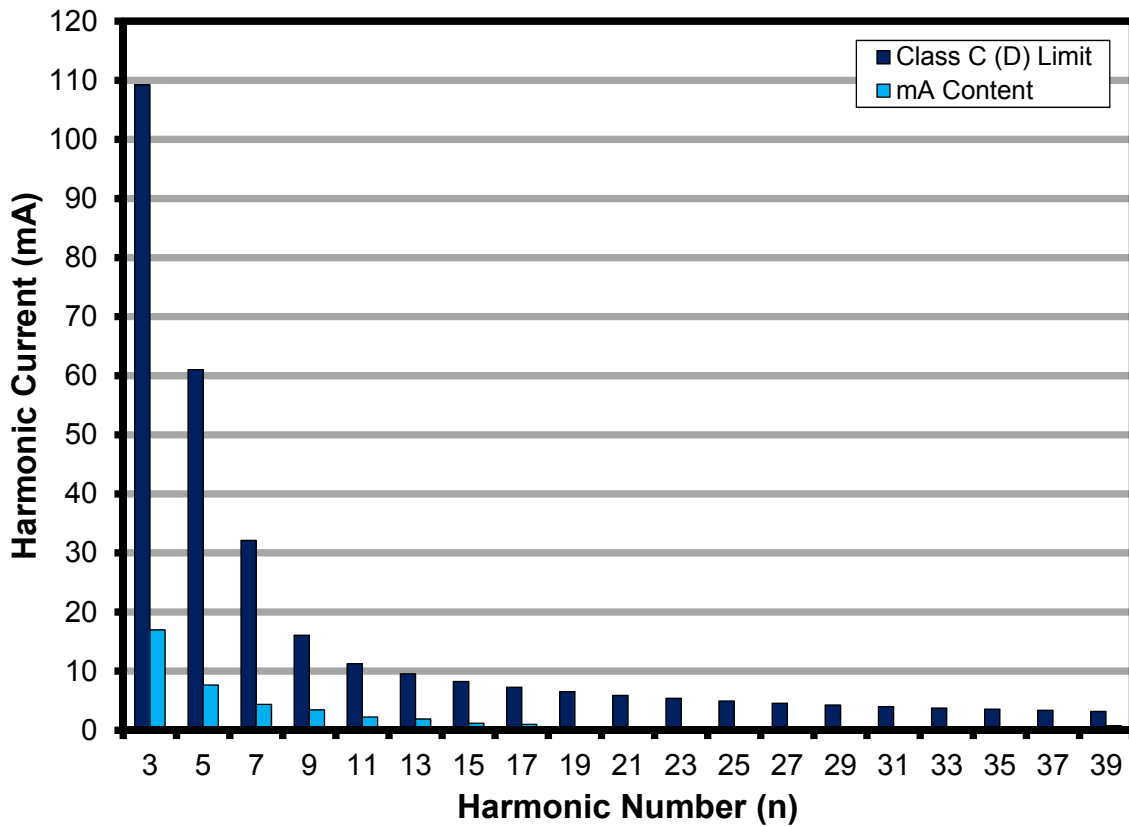

Figure 82 – 38 V LED Load Input Current Harmonics (IEC61000-3-2) at 120 VAC, 60 Hz.



16.8 Test Data

All measurements were taken with the board at open frame, 25 °C ambient, and 60 Hz line frequency.

16.8.1 Test Data, 30 V LED Load

Input		Input Measurement					Load Measurement			Calculation		
VAC (V _{RMS})	Freq (Hz)	V _{IN} (V _{RMS})	I _{IN} (mA _{RMS})	P _{IN} (W)	PF	%ATHD	V _{OUT} (V _{DC})	I _{OUT} (mA _{DC})	P _{OUT} (W)	P _{CAL} (W)	Efficiency (%)	Loss (W)
90	60	90.05	132.11	11.730	0.986	11.94	30.2660	328.210	9.944	9.93	84.77	1.79
100	60	100.02	123.14	12.082	0.981	13.55	30.3230	339.660	10.310	10.30	85.33	1.77
110	60	110.08	117.42	12.609	0.976	14.59	30.3990	355.180	10.809	10.80	85.72	1.80
120	60	120.06	111.69	12.988	0.969	16.1	30.4470	366.480	11.170	11.16	86.00	1.82
132	60	132.09	106.28	13.471	0.960	17.65	30.5080	380.480	11.621	11.61	86.27	1.85

16.8.2 Test Data, 34 V LED Load

Input		Input Measurement					Load Measurement			Calculation		
VAC (V _{RMS})	Freq (Hz)	V _{IN} (V _{RMS})	I _{IN} (mA _{RMS})	P _{IN} (W)	PF	%ATHD	V _{OUT} (V _{DC})	I _{OUT} (mA _{DC})	P _{OUT} (W)	P _{CAL} (W)	Efficiency (%)	Loss (W)
90	60	90.05	145.38	12.934	0.988	11.43	33.1680	329.690	10.940	10.94	84.58	1.99
100	60	100.02	135.26	13.306	0.984	12.83	33.2850	340.440	11.337	11.33	85.20	1.97
110	60	110.08	128.76	13.875	0.979	13.96	33.4460	355.100	11.882	11.88	85.64	1.99
120	60	120.05	122.29	14.281	0.973	15.54	33.5500	365.770	12.278	12.27	85.97	2.00
132	60	132.08	116.15	14.799	0.965	17.22	33.6830	378.850	12.767	12.76	86.27	2.03

16.8.3 Test Data, 38 V LED Load

Input		Input Measurement					Load Measurement			Calculation		
VAC (V _{RMS})	Freq (Hz)	V _{IN} (V _{RMS})	I _{IN} (mA _{RMS})	P _{IN} (W)	PF	%ATHD	V _{OUT} (V _{DC})	I _{OUT} (mA _{DC})	P _{OUT} (W)	P _{CAL} (W)	Efficiency (%)	Loss (W)
90	60	90.04	166.65	14.861	0.990	10.47	37.5220	333.380	12.518	12.51	84.23	2.34
100	60	100.01	153.57	15.156	0.987	11.85	37.5670	342.310	12.869	12.86	84.91	2.29
110	60	110.07	145.10	15.696	0.983	13.07	37.6440	355.910	13.408	13.40	85.42	2.29
120	60	120.05	136.91	16.066	0.978	14.65	37.6890	365.500	13.786	13.78	85.81	2.28
132	60	132.08	129.21	16.557	0.970	16.4	37.7490	377.550	14.263	14.25	86.14	2.29



16.8.4 120 VAC 60 Hz, 30 V LED Load Harmonics Data

Current Harmonics Limits for IEC61000-3-2

V	Freq	I (mA)	P	PF	%THD
120	60.00	111.69	12.9880	0.9686	16.1
nth Order	mA Content	% Content	Limit <25 W	Limit >25 W	Remarks
1	109.96				
2	0.05	0.05%		2.00%	
3	14.68	13.35%	88.3184	29.06%	Pass
5	7.17	6.52%	49.3544	10.00%	Pass
7	4.22	3.84%	25.9760	7.00%	Pass
9	3.50	3.18%	12.9880	5.00%	Pass
11	2.36	2.15%	9.0916	3.00%	Pass
13	2.13	1.94%	7.6929	3.00%	Pass
15	1.34	1.22%	6.6672	3.00%	Pass
17	1.16	1.05%	5.8828	3.00%	Pass
19	0.60	0.55%	5.2636	3.00%	Pass
21	0.48	0.44%	4.7623	3.00%	Pass
23	0.20	0.18%	4.3482	3.00%	Pass
25	0.32	0.29%	4.0003	3.00%	Pass
27	0.14	0.13%	3.7040	3.00%	Pass
29	0.39	0.35%	3.4485	3.00%	Pass
31	0.29	0.26%	3.2261	3.00%	Pass
33	0.47	0.43%	3.0305	3.00%	Pass
35	0.49	0.45%	2.8574	3.00%	Pass
37	0.49	0.45%	2.7029	3.00%	Pass
39	0.58	0.53%	2.5643	3.00%	Pass
41	0.39	0.35%			
43	0.49	0.45%			
45	0.34	0.31%			
47	0.37	0.34%			
49	0.34	0.31%			



16.8.5 120 VAC 60 Hz, 34 V LED Load Harmonics Data

Current Harmonics Limits for IEC61000-3-2

V	Freq	I (mA)	P	PF	%THD
120	60.00	122.29	14.2810	0.9728	15.54
nth Order	mA Content	% Content	Limit <25 W	Limit >25 W	Remarks
1	120.55				
2	0.06	0.05%		2.00%	
3	15.76	13.07%	97.1108	29.18%	Pass
5	7.43	6.16%	54.2678	10.00%	Pass
7	4.34	3.60%	28.5620	7.00%	Pass
9	3.53	2.93%	14.2810	5.00%	Pass
11	2.36	1.96%	9.9967	3.00%	Pass
13	2.09	1.73%	8.4587	3.00%	Pass
15	1.31	1.09%	7.3309	3.00%	Pass
17	1.10	0.91%	6.4685	3.00%	Pass
19	0.57	0.47%	5.7876	3.00%	Pass
21	0.47	0.39%	5.2364	3.00%	Pass
23	0.15	0.12%	4.7810	3.00%	Pass
25	0.39	0.32%	4.3985	3.00%	Pass
27	0.17	0.14%	4.0727	3.00%	Pass
29	0.45	0.37%	3.7919	3.00%	Pass
31	0.33	0.27%	3.5472	3.00%	Pass
33	0.50	0.41%	3.3322	3.00%	Pass
35	0.52	0.43%	3.1418	3.00%	Pass
37	0.50	0.41%	2.9720	3.00%	Pass
39	0.56	0.46%	2.8196	3.00%	Pass
41	0.42	0.35%			
43	0.49	0.41%			
45	0.35	0.29%			
47	0.37	0.31%			
49	0.35	0.29%			



16.8.7 120 VAC 60 Hz, 38 V LED Load Harmonics Data

Current Harmonics Limits for IEC61000-3-2

V	Freq	I (mA)	P	PF	%THD
120	60.00	136.91	16.0660	0.9775	14.65
<hr/>					
nth Order	mA Content	% Content	Limit <25 W	Limit >25 W	Remarks
1	135.18				
2	0.08	0.06%		2.00%	
3	16.98	12.56%	109.2488	29.33%	Pass
5	7.65	5.66%	61.0508	10.00%	Pass
7	4.36	3.23%	32.1320	7.00%	Pass
9	3.42	2.53%	16.0660	5.00%	Pass
11	2.22	1.64%	11.2462	3.00%	Pass
13	1.91	1.41%	9.5160	3.00%	Pass
15	1.18	0.87%	8.2472	3.00%	Pass
17	0.98	0.72%	7.2770	3.00%	Pass
19	0.50	0.37%	6.5110	3.00%	Pass
21	0.51	0.38%	5.8909	3.00%	Pass
23	0.20	0.15%	5.3786	3.00%	Pass
25	0.55	0.41%	4.9483	3.00%	Pass
27	0.32	0.24%	4.5818	3.00%	Pass
29	0.57	0.42%	4.2658	3.00%	Pass
31	0.42	0.31%	3.9906	3.00%	Pass
33	0.50	0.37%	3.7487	3.00%	Pass
35	0.51	0.38%	3.5345	3.00%	Pass
37	0.43	0.32%	3.3435	3.00%	Pass
39	0.75	0.55%	3.1720	3.00%	Pass
41	0.63	0.47%			
43	0.43	0.32%			
45	0.32	0.24%			
47	0.31	0.23%			
49	0.35	0.26%			



16.9 Dimming Curve with Simulated TRIAC

Using Agilent 6812B AC source programmed as perfect leading edge dimmer

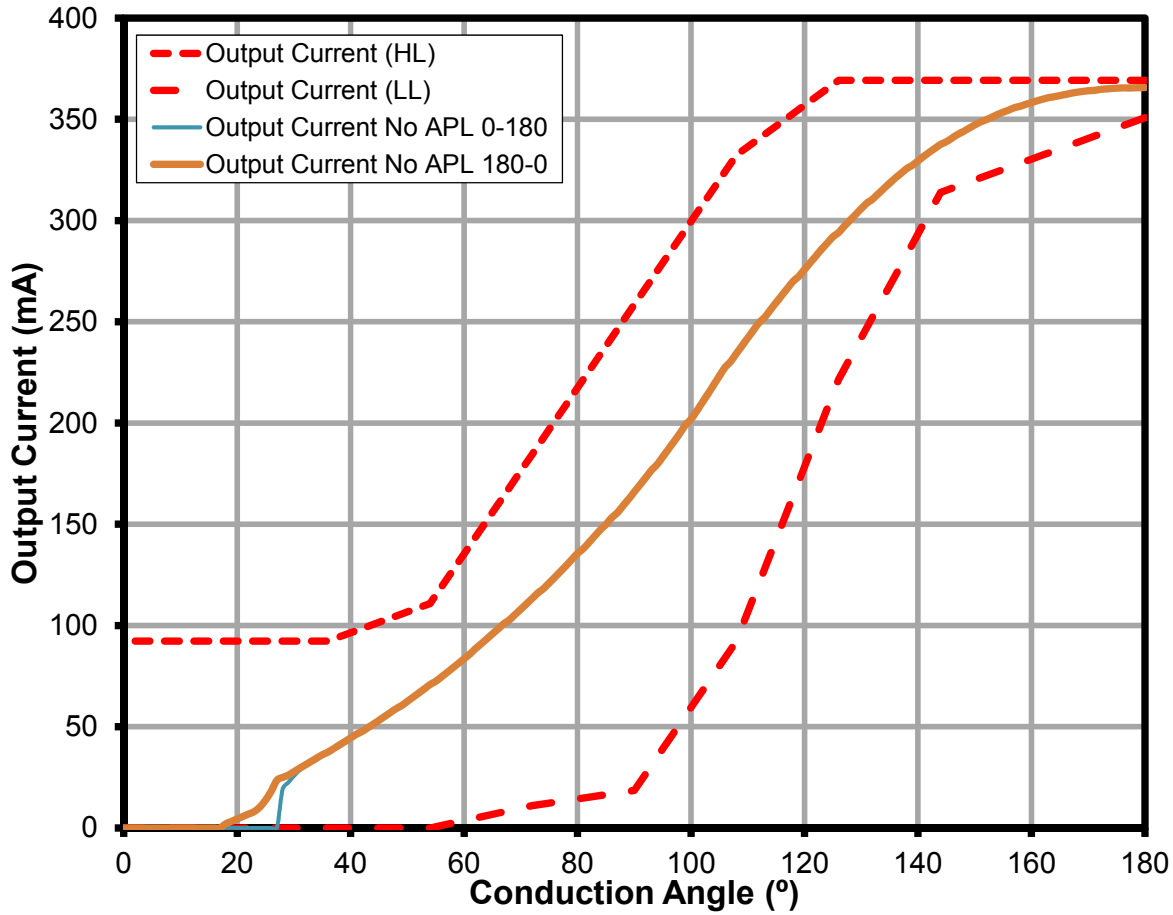

Figure 83 – Dimming Curve at 120 VAC, 60 Hz Input.



16.10 Dimmer Compatibility List

The following dimmers were tested with utility line input (~120 VAC, 60 Hz) and ~34 V LED load.

	List of Dimmers	Type	Part Number	Max I _{OUT} (mA)	Min I _{OUT} (mA)	Dim Ratio
1	LUTRON LG600PH-LA	L	LG-600PH-WH	339	32	11
2	LUTRON S603P	L	S-603P-WH	341	31	11
3	LUTRON SLV600P	L	SLV600P-WH	346	42	8
4	LUTRON S600	L	S-600-WH	363	35	10
5	LUTRON S-600PH-WH	L	S-600PH-WH	342	26	13
6	LUTRON DVCL153P	L	DVWCL-153-PLH-WH	331	82	4
7	LUTRON DV603P	L	DV-603P-WH	340	34	10
8	LUTRON DV600P	L	DV-600P-WH	340	32	11
9	LUTRON TG600PH-IV	L	TG-600PH-WH	350	49	7
10	LUTRON AY600P	L	AY-600P-WH	345	51	7
11	LUTRON GL600P-WH	L	GL-600P-WH	341	38	9
12	LEVITON 6633PLI	L	R62-06633-1LW	372	30	12
13	LEVITON 6631-LI	L	R62-06631-1LW	353	3	118
14	LEVITON IPI06	L	R60-IPI06-1LM	368	54	7
15	LEVITON 6161-I	E	R52-06161-00W	343	42	8
16	LEVITON RP106	L	R52-RPI06-1LW	376	40	9
17	LEVITON 6681	L	R60-06681-0IW	362	9	40
18	LEVITON TGM10-1LW	T	TGM10-1LW	330	20	17
19	LEVITON 6684	L	R60-06684-1IW	377	10	38
20	LEVITON 6683		6683	377	15	25
21	LEVITON 6613	L	R02-06613-PLW	373	26	14
22	COOPER SLC03		SLC03P-W-K-L	352	75	5
23	LUTRON GL600-WH	L	GL-600-WH	361	39	9
24	LUTRON DVPDC-203P-WH	L	DVPDC-203P-WH	358	102	4
25	LUTRON LX600PL	L	LX-600PL-wh	355	36	10
26	LUTRON D600P	L	D-600P-WH	330	5	66
27	LUTRON CTCL-153PDH			334	0.5	668
28	LUTRON S-600P		S-600P	342	26	13
29	LUTRON TGLV-600P		TGLV-600P	350	48	7
30	LUTRON TGLV-600PR		TGLV-600PR	345	49	7
31	LUTRON TT-300NLH-WH	L	TT-300NLH-WH	366	36	10
32	LUTRON NLV-1000-WH	L	NLV-1000-WH	352	33	11

L: Leading edge, E: Electronic



17 Alternate EMI Configuration for Leading Edge TRIAC Dimming with Reduced Audible Noise

Audible Noise with Leading Edge TRIAC Dimmer operation can be reduced by replacing the differential chokes L2 and L3 with a high saturation type inductor. On the schematic below, L2 and L3 were replaced with a single differential choke L3. Common mode choke L1 was also replaced to compensate for the reduced filtering caused by removing L2.

The active pre-load were also adjusted to give 1% dimming at 30 V_{RMS} input voltage.

17.1 Schematic

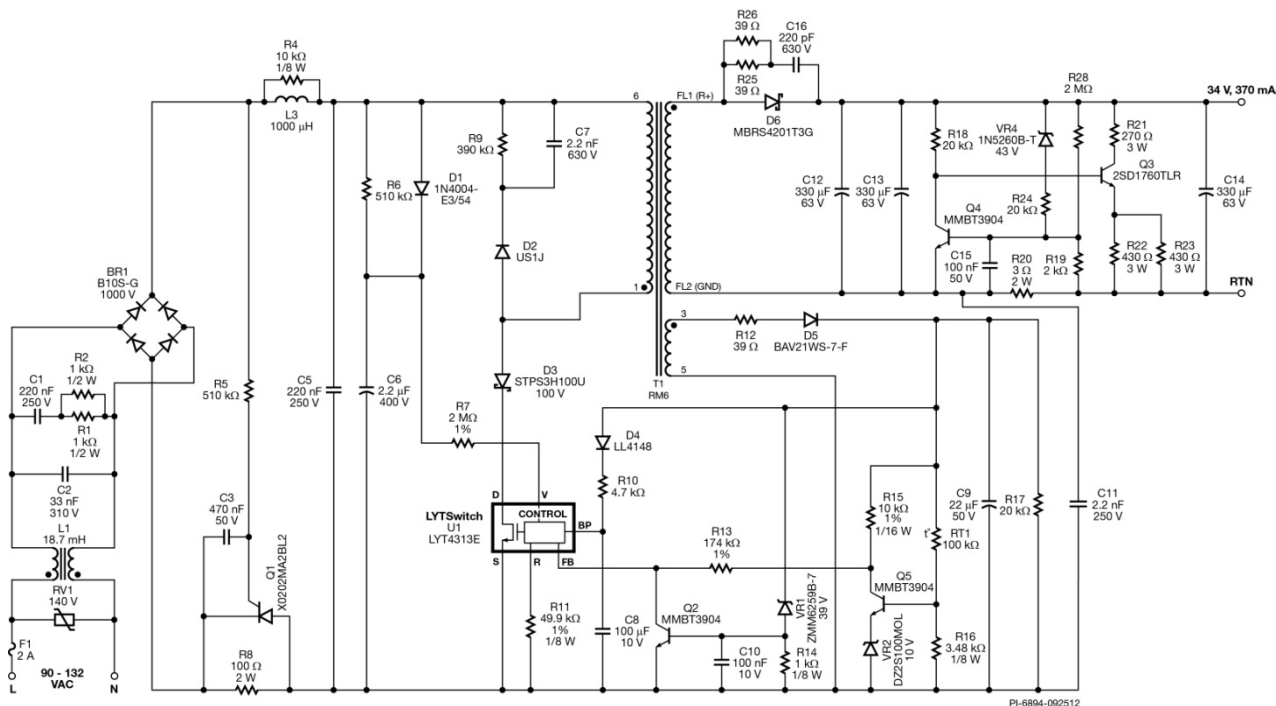

Figure 84 – Schematic with Reduced Audible Noise and 1% Dimming at 30 V_{RMS} Input.



17.2 Bill of Materials

Item	Qty	Ref Des	Description	Mfg Part Number	Mfg
1	1	BR1	1000 V, 0.8 A, Bridge Rectifier, SMD, MBS-1, 4-SOIC	B10S-G	Comchip
2	2	C1 C5	220 nF, 250 V, Film	ECQ-E2224KF	Panasonic
3	1	C2	33 nF, 310 VAC, Polyester Film, X2	BFC233920333	Vishay
4	1	C3	470 nF, 50 V, Ceramic, Y5G, 0603	C1608Y5V1H474Z	TDK
5	1	C6	2.2 μ F, 400 V, Electrolytic, (8 x 11.5)	SMG400VB2R2M8X11LL	Nippon Chemi-Con
6	1	C7	2.2 nF, 630 V, Ceramic, X7R, 1206	ECJ-3FBJ222K	Panasonic
7	1	C8	100 μ F, 10 V, X5R, 1206	C3216X5R1A107M	TDK
8	1	C9	22 μ F, 50 V, Electrolytic, Low ESR, 900 m Ω , (5 x 11.5)	ELXZ500ELL220MEB5D	Nippon Chemi-Con
9	2	C10 C15	100 nF, 50 V, Ceramic, X7R, 0805	CC0805KRX7R9BB104	Yageo
10	1	C11	2.2 nF, Ceramic, Y1	440LD22-R	Vishay
11	3	C12 C13 C14	330 μ F, 63, Electrolytic, Low ESR, 85 m Ω , (12.5 x 20)	ELXZ630ELL331MK20S	Nippon Chemi-Con
12	1	C16	220 pF, 630 V, Ceramic, NPO, 1206	C3216C0G2J221J	TDK
13	1	D1	400 V, 1 A, Rectifier, DO-41	1N4004-E3/54	Vishay
14	1	D2	Diode Ultrafast, SW 600 V, 1A, SMA	US1J-13-F	Diodes, Inc.
15	1	D3	100 V, 3 A, Schottky, DO-214AA	STPS3H100U	ST Micro
16	1	D4	75 V, 0.15 A, Fast Switching, 4 ns, MELF	LL4148-13	Diodes, Inc.
17	1	D5	250 V, 0.2 A, Fast Switching, 50 ns, SOD-323	BAV21WS-7-F	Diodes, Inc.
18	1	D6	200 V, 4 A, Schottky, SMC, DO-214AB	MBRS4201T3G	On Semi
19	1	F1	2 A, 250 V, Slow, Long Time Lag, RST	RST 2	Belfuse
20	1	L1	18.7 mH, 0.22 A, Common Mode Choke	RL-4400-1-18.7	Renco
21	1	L3	1000 μ H, 0.56 A	SBC6-102-561	Tokin
22	1	Q1	SCR, 600 V, 1.25 A, TO-92	X0202MA 2BL2	ST Micro
23	3	Q2 Q4 Q5	NPN, Small Signal BJT, 40 V, 0.2 A, SOT-23	MMBT3904LT1G	On Semi
24	1	Q3	NPN, Power BJT, 400 V, 2 A, SOT-428	2SD1760TLR	Rohm
25	2	R1 R2	1 k Ω , 5%, 1/2 W, Thick Film, 1210	ERJ-14YJ102U	Panasonic
26	1	R4	10 k Ω , 5%, 1/8 W, Thick Film, 0805	ERJ-6GEYJ103V	Panasonic
27	1	R5	510 k Ω , 5%, 1/4 W, Thick Film, 1206	ERJ-8GEYJ514V	Panasonic
28	1	R6	510 k Ω , 5%, 1/4 W, Carbon Film	CFR-25JB-510K	Yageo
29	2	R7 R28	2.00 M Ω , 1%, 1/4 W, Thick Film, 1206	ERJ-8ENF2004V	Panasonic
30	1	R8	100 Ω , 5%, 2 W, Metal Oxide	RSMF2JT100R	Stackpole
31	1	R9	390 k Ω , 5%, 1/4 W, Thick Film, 1206	ERJ-8GEYJ394V	Panasonic
32	1	R10	4.7 k Ω , 5%, 1/4 W, Thick Film, 1206	ERJ-8GEYJ472V	Panasonic
33	1	R11	49.9 k Ω , 1%, 1/8 W, Thick Film, 0805	ERJ-6ENF4992V	Panasonic
34	3	R12 R25 R26	39 Ω , 5%, 1/4 W, Thick Film, 1206	ERJ-8GEYJ390V	Panasonic
35	1	R13	174 k Ω , 1%, 1/4 W, Thick Film, 1206	ERJ-8ENF1743V	Panasonic
36	1	R14	1 k Ω , 5%, 1/8 W, Thick Film, 0805	ERJ-6GEYJ102V	Panasonic
37	1	R15	10 k Ω , 1%, 1/16 W, Thick Film, 0603	ERJ-3EKF1002V	Panasonic
38	1	R16	3.48 k Ω , 1%, 1/8 W, Thick Film, 0805	ERJ-6ENF3481V	Panasonic
39	3	R17 R18 R24	20 k Ω , 5%, 1/4 W, Thick Film, 1206	ERJ-8GEYJ203V	Panasonic
40	1	R19	20 k Ω , 5%, 1/4 W, Carbon Film	CFR-25JB-20K	Yageo
41	1	R20	3 Ω , 5%, 2 W, Metal Oxide	RSF200JB-3R0	Yageo
42	1	R21	270 Ω , 5%, 3 W, Metal Oxide	ERG-3SJ271	Panasonic
43	2	R22 R23	430 Ω , 5%, 3 W, Metal Oxide	ERG-3SJ431	Panasonic
44	1	RT1	NTC Thermistor, 100 k Ω , 0.00014 A	NTSA0WF104EE1B0	Murata
45	1	RV1	140 V, 12 J, 7 mm, RADIAL	V140LA2P	Littlefuse



46	1	T1	Bobbin, RM6, Vertical, 6 pins	B65808-N1006-D1	Epcos
47	1	U1	LYTSwitch, eSIP-7C	LYT4313E	Power Integrations
48	1	VR1	39 V, 5%, 500 mW, DO-213AA (MELF)	ZMM5259B-7	Diodes Inc
49	1	VR2	10 V, 5%, 150 mW, SSMINI-2	DZ2S100M0L	Panasonic
50	1	VR4	43 V, 5%, 500 mW, DO-35	1N5260B-T	Diodes Inc



17.3 Efficiency, PF, THD Data

The following were measured at room temperature and 34 V LED load.

Input		Input Measurement					Load Measurement			Calculation		
VAC (V _{RMS})	Freq (Hz)	V _{IN} (V _{RMS})	I _{IN} (mA _{RMS})	P _{IN} (W)	PF	%ATHD	V _{OUT} (V _{DC})	I _{OUT} (mA _{DC})	P _{OUT} (W)	P _{CAL} (W)	Efficiency (%)	Loss (W)
90	60	90.03	154.51	13.714	0.986	13.76	33.47	335.65	11.24	11.23	81.93	2.48
100	60	100.00	143.39	14.082	0.982	14.67	33.57	345.98	11.62	11.61	82.50	2.46
110	60	110.06	136.15	14.654	0.978	15.61	33.72	359.98	12.14	12.14	82.85	2.51
120	60	120.03	129.04	15.067	0.973	16.79	33.81	370.24	12.52	12.52	83.11	2.55
132	60	132.06	122.29	15.588	0.965	18.3	33.93	382.61	12.99	12.98	83.31	2.60



17.4 Dimming Data

17.4.1 Leading Edge Dimmer Test Data

Input: 120 VAC, 60 Hz

Dimmer: LUTRON S-600P-WH

$V_{IN(RMS)}$ (V)	I_{OUT} (mA)	I_{OUT} (%)	V_{OUT} (V)	P_{OUT} (W)	P_{IN} (W)	Efficiency (%)	P_{LOSS} (W)	Start-upTime (ms)
114.5	330	89.19%	33.6	11.09	15.2	73.0%	4.11	150
110	301	81.35%	32.97	9.96	14.1	70.6%	4.14	150
100	247	66.76%	32.2	7.98	12.09	66.0%	4.11	190
90	177	47.84%	31.13	5.55	9.9	56.1%	4.35	210
80	124	33.51%	30.17	3.76	8.47	44.4%	4.71	240
70	83	22.43%	29.23	2.43	7.11	34.2%	4.68	290
60	51.5	13.92%	28.35	1.46	6.1	23.9%	4.64	390
50	28.6	7.73%	27.56	0.79	5.25	15.0%	4.46	500
40	10.2	2.76%	26.48	0.273	4.34	6.3%	4.067	1000
35	3.38	0.91%	25.73	0.087	3.97	2.2%	3.883	2000
30	0.08	0.02%	23.98	0.002	3.56	0.1%	3.558	didn't start

17.4.2 Trailing Edge Dimmer Test Data

Input: 120 VAC, 60 Hz

Dimmer: LUTRON DVELV-300P-WH

$V_{IN(RMS)}$ (V)	I_{OUT} (mA)	I_{OUT} (%)	V_{OUT} (V)	P_{OUT} (W)	P_{IN} (W)	Efficiency (%)	P_{LOSS} (W)	Start-upTime (ms)
113.7	325	87.84%	33.44	10.8	14.46	74.7%	3.66	150
110	305	82.43%	33.48	10.22	13.7	74.6%	3.48	150
100	251	67.84%	32.53	8.19	11.33	72.3%	3.14	180
90	195	52.70%	31.62	6.18	9.37	66.0%	3.19	200
80	132	35.68%	30.43	4.04	7.65	52.8%	3.61	280
70	93.5	25.27%	29.55	2.76	6.44	42.9%	3.68	300
60	61	16.49%	28.68	1.75	5.4	32.4%	3.65	350
50	32	8.65%	27.67	0.89	4.49	19.8%	3.6	500
40	11.27	3.05%	26.6	0.3	3.6	8.3%	3.3	800
35	3.7	1.00%	25.81	0.096	3.3	2.9%	3.204	1500
30	0.01	0.00%	23	0.00016	2.84	0.0%	2.83984	1500



17.4.3 Dimming Curve

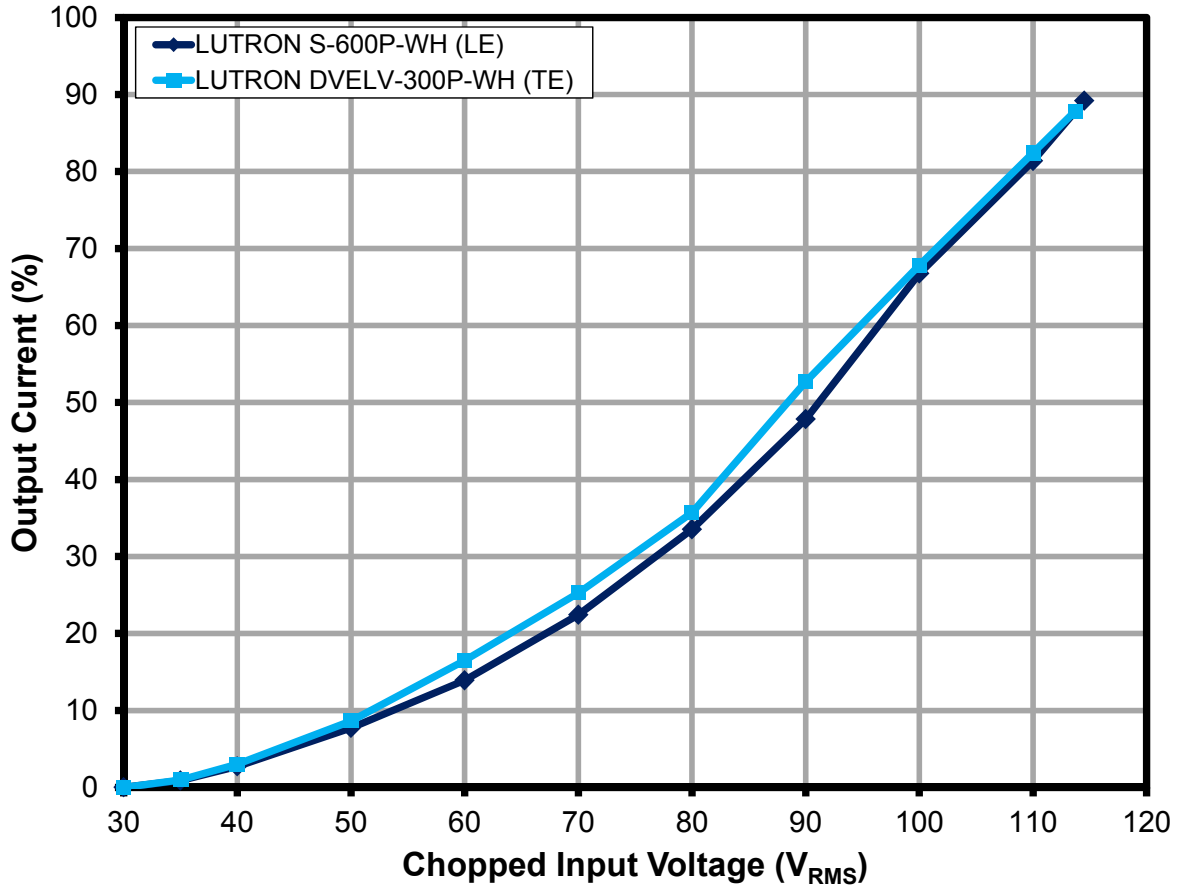
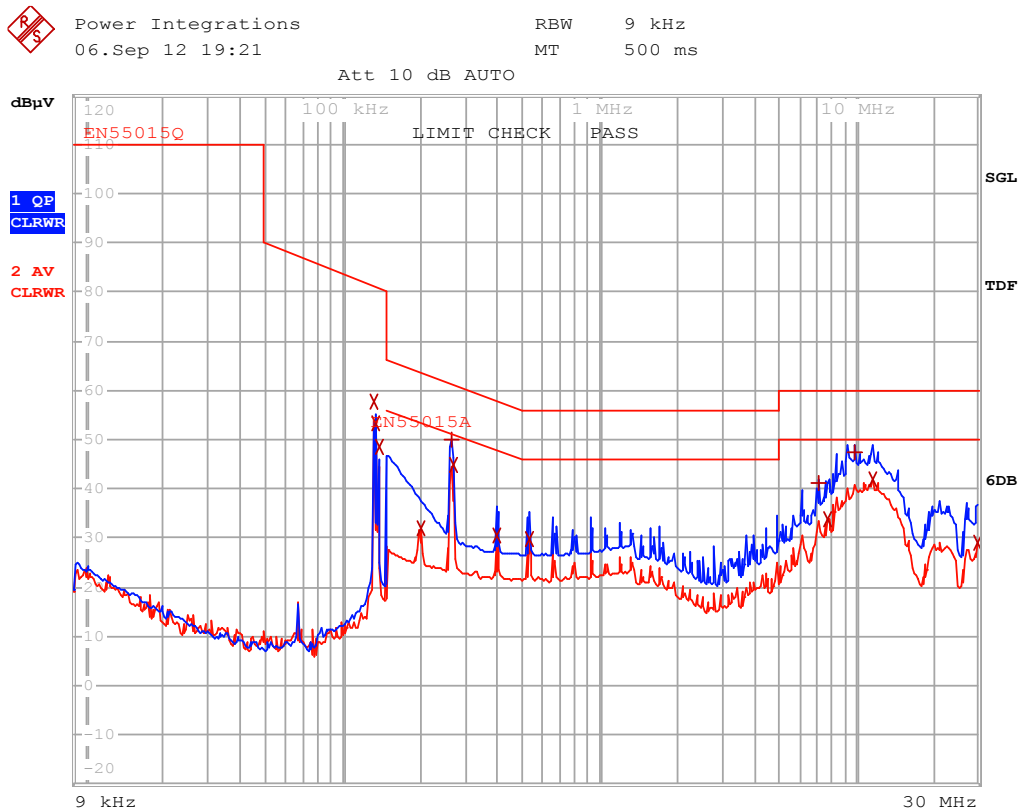

Figure 85 – Dimming Curve as a Function of Chopped Input Voltage RMS.



17.5 Conducted EMI

Refer to Section 14.1 for test set-up.



EDIT PEAK LIST (Final Measurement Results)

Trace1: EN55015Q
Trace2: EN55015A
Trace3: ---

TRACE	FREQUENCY	LEVEL dBµV	DELTA LIMIT dB
2 Average	130.825395691 kHz	57.57 N gnd	
2 Average	133.454986145 kHz	53.44 L1 gnd	
2 Average	137.49880568 kHz	48.36 L1 gnd	
2 Average	200.175581485 kHz	32.13 L1 gnd	-21.46
1 Quasi Peak	264.49018761 kHz	50.00 L1 gnd	-11.28
2 Average	267.135089486 kHz	44.80 L1 gnd	-6.39
2 Average	397.727746704 kHz	30.37 L1 gnd	-17.53
2 Average	530.769219795 kHz	29.66 L1 gnd	-16.33
1 Quasi Peak	7.12499045243 MHz	41.30 L1 gnd	-18.69
2 Average	7.71534368894 MHz	33.94 L1 gnd	-16.05
1 Quasi Peak	9.89440359926 MHz	47.50 N gnd	-12.49
2 Average	11.6019663647 MHz	41.98 L1 gnd	-8.01
2 Average	29.8580960942 MHz	29.05 L1 gnd	-20.94

Figure 86 – Conducted EMI, 34 V LED Load, 120 VAC, 60 Hz, and EN55015 B Limits.



18 Revision History

Date	Author	Revision	Description and Changes	Reviewed
13-Nov-12	CA	1.1	Initial Release	Apps & Mktg
11-Feb-13	ME	1.2	Text Edits	



For the latest updates, visit our website: www.powerint.com

Power Integrations reserves the right to make changes to its products at any time to improve reliability or manufacturability. Power Integrations does not assume any liability arising from the use of any device or circuit described herein. POWER INTEGRATIONS MAKES NO WARRANTY HEREIN AND SPECIFICALLY DISCLAIMS ALL WARRANTIES INCLUDING, WITHOUT LIMITATION, THE IMPLIED WARRANTIES OF MERCHANTABILITY, FITNESS FOR A PARTICULAR PURPOSE, AND NON-INFRINGEMENT OF THIRD PARTY RIGHTS.

PATENT INFORMATION

The products and applications illustrated herein (including transformer construction and circuits' external to the products) may be covered by one or more U.S. and foreign patents, or potentially by pending U.S. and foreign patent applications assigned to Power Integrations. A complete list of Power Integrations' patents may be found at www.powerint.com. Power Integrations grants its customers a license under certain patent rights as set forth at <http://www.powerint.com/ip.htm>.

The PI Logo, TOPSwitch, TinySwitch, LinkSwitch, LYTSwitch, DPA-Switch, PeakSwitch, CAPZero, SENZero, LinkZero, HiperPFS, HiperTFS, HiperLCS, Qspeed, EcoSmart, Clampless, E-Shield, Filterfuse, StackFET, PI Expert and PI FACTS are trademarks of Power Integrations, Inc. Other trademarks are property of their respective companies. ©Copyright 2013 Power Integrations, Inc.

Power Integrations Worldwide Sales Support Locations

WORLD HEADQUARTERS

5245 Hellyer Avenue
San Jose, CA 95138, USA.
Main: +1-408-414-9200
Customer Service:
Phone: +1-408-414-9665
Fax: +1-408-414-9765
e-mail: usasales@powerint.com

GERMANY

Lindwurmstrasse 114
80337, Munich
Germany
Phone: +49-895-527-39110
Fax: +49-895-527-39200
e-mail: eurosales@powerint.com

JAPAN

Kosei Dai-3 Building
2-12-11, Shin-Yokohama,
Kohoku-ku, Yokohama-shi,
Kanagawa 222-0033
Japan
Phone: +81-45-471-1021
Fax: +81-45-471-3717
e-mail: japansales@powerint.com

TAIWAN

5F, No. 318, Nei Hu Rd.,
Sec. 1
Nei Hu District
Taipei 11493, Taiwan R.O.C.
Phone: +886-2-2659-4570
Fax: +886-2-2659-4550
e-mail: taiwansales@powerint.com

CHINA (SHANGHAI)

Rm 1601/1610, Tower 1,
Kerry Everbright City
No. 218 Tianmu Road West,
Shanghai, P.R.C. 200070
Phone: +86-21-6354-6323
Fax: +86-21-6354-6325
e-mail: chinasales@powerint.com

INDIA

#1, 14th Main Road
Vasanthanagar
Bangalore-560052
India
Phone: +91-80-4113-8020
Fax: +91-80-4113-8023
e-mail: indiasales@powerint.com

KOREA

RM 602, 6FL
Korea City Air Terminal B/D,
159-6
Samsung-Dong, Kangnam-Gu,
Seoul, 135-728 Korea
Phone: +82-2-2016-6610
Fax: +82-2-2016-6630
e-mail: koreasales@powerint.com

EUROPE HQ

1st Floor, St. James's House
East Street, Farnham
Surrey GU9 7TJ
United Kingdom
Phone: +44 (0) 1252-730-141
Fax: +44 (0) 1252-727-689
e-mail: eurosales@powerint.com

CHINA (SHENZHEN)

3rd Floor, Block A,
Zhongtuo International Business
Center, No. 1061, Xiang Mei Rd,
FuTian District, ShenZhen,
China, 518040
Phone: +86-755-8379-3243
Fax: +86-755-8379-5828
e-mail: chinasales@powerint.com

ITALY

Via Milanese 20, 3rd Fl.
20099 Sesto San Giovanni
(MI) Italy
Phone: +39-024-550-8701
Fax: +39-028-928-6009
e-mail: eurosales@powerint.com

SINGAPORE

51 Newton Road,
#19-01/05 Goldhill Plaza
Singapore, 308900
Phone: +65-6358-2160
Fax: +65-6358-2015
e-mail: singaporesales@powerint.com

APPLICATIONS HOTLINE

World Wide +1-408-414-9660

APPLICATIONS FAX

World Wide +1-408-414-9760

