

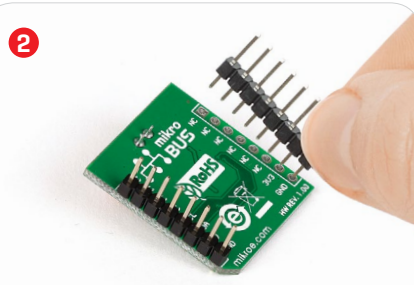

DAC 3 click

2. Soldering the headers

Before using your click board™, make sure to solder 1x8 male headers to both left and right side of the board. Two 1x8 male headers are included with the board in the package.

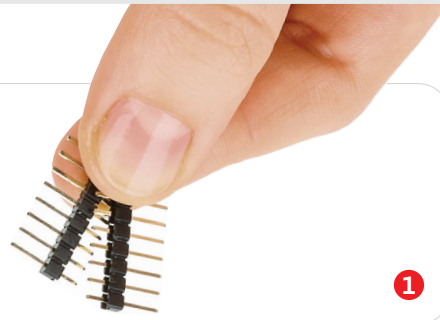

Turn the board upside down so that the bottom side is facing you upwards. Place shorter pins of the header into the appropriate soldering pads.

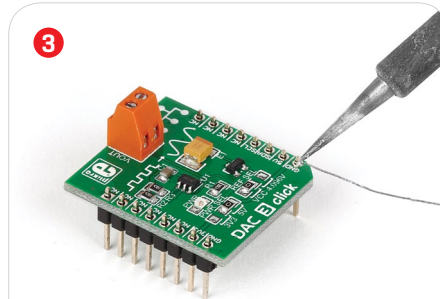

Turn the board upward again. Make sure to align the headers so that they are perpendicular to the board, then solder the pins carefully.

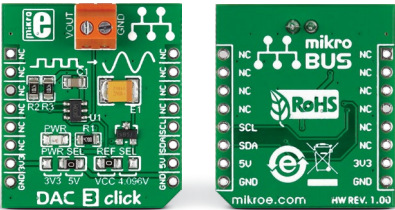

1. Introduction

DAC 3 click carries Microchip's **MCP4726**, a 12-bit digital-to-analog converter, along with voltage output screw terminals. The IC has EEPROM, configurable reference voltage, and communicates with the target board MCU through the mikroBUS™ I2C interface [SCL, SDA pins]. Standard [100 kHz], fast [400 kHz] and highspeed [3.4 MHz] I2C modes are available. The board uses either a 3.3V or a 5V power supply. The board is suitable for sensor calibration, motor control, set point or offset trimming and many other applications.

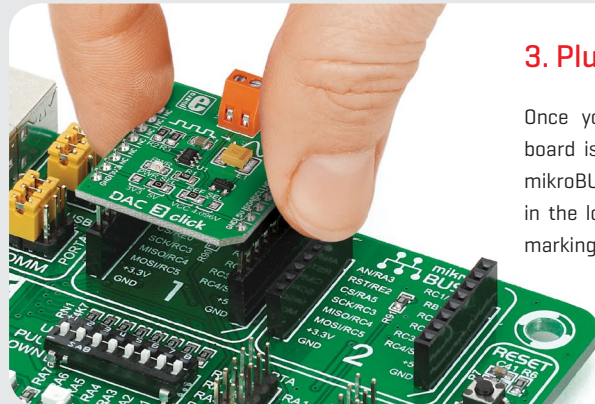

3. Plugging the board in

Once you have soldered the headers your board is ready to be placed into the desired mikroBUS™ socket. Make sure to align the cut in the lower-right part of the board with the markings on the silkscreen at the mikroBUS™ socket. If all the pins are aligned correctly, push the board all the way into the socket.

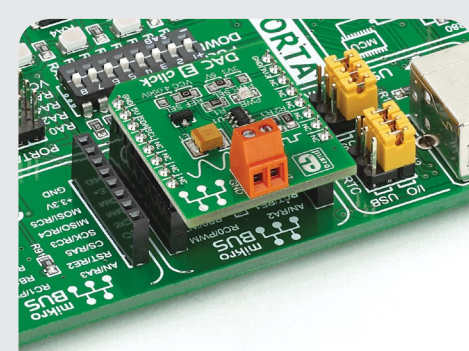

4. Essential features

DAC 3 click contains two analog output screw terminals: Vout and GND. 16-bit data is sent to the DAC through I2C. The digital value is converted to the appropriate voltage level in the range between GND and REFERENCE [VCC or 4.096V], which is proportional to the received 12-bit number. MCP4726 also integrates EEPROM for storing DAC register and configuration bit values.



DAC 3 click Manual v100



0100000093788

5. Schematic

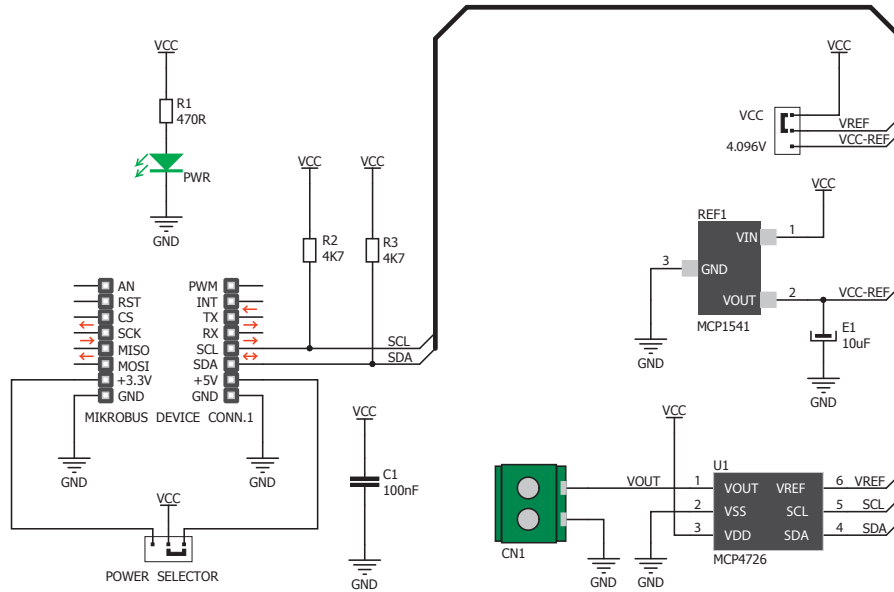

6. Dimensions

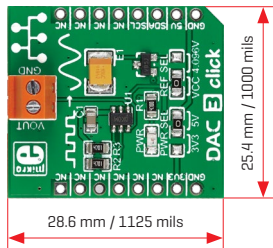

| | mm | mils |
|---------|------|------|
| LENGTH | 28.6 | 1125 |
| WIDTH | 25.4 | 1000 |
| HEIGHT* | 3.3 | 130 |

* without headers

7. SMD jumpers

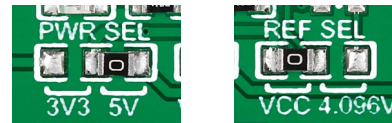

DAC 3 click features two SMD jumpers: PWR SEL for switching between a 3.3V or a 5V power supply, and REF SEL for choosing either VCC or 4.096V as a reference voltage.

8. Code examples

Once you have done all the necessary preparations, it's time to get your click board™ up and running. We have provided examples for mikroC™, mikroBasic™ and mikroPascal™ compilers on our **Libstock** website. Just download them and you are ready to start.



9. Support

MikroElektronika offers **free tech support** [www.mikroe.com/support] until the end of the product's lifetime, so if something goes wrong, we're ready and willing to help!



10. Disclaimer

MikroElektronika assumes no responsibility or liability for any errors or inaccuracies that may appear in the present document. Specification and information contained in the present schematic are subject to change at any time without notice.

Copyright © 2016 MikroElektronika.
All rights reserved.