

PROTECTION PRODUCTS - MicroClamp®

Description

The μ Clamp®3603T is a high-surge transient voltage suppressor (TVS) optimized for protection of sensitive digital sensors used in proximity switches and industrial control applications. The μ Clamp3603T protects the components from over-voltages caused by **Electro-Static Discharge (ESD)**, **Electrical Fast Transients (EFT)**, and **Tertiary Lightning**.

The μ Clamp3603T features a working voltage of 36 volts with a minimum breakdown voltage of 37 volts. They are rated to handle a continuous forward current of up to 200mA with a low forward voltage drop of less than 1 volt ($I_F = 200\text{mA}$). They are designed with high surge capability (2 Amps at $t_p=1.2/50\mu\text{s}$) and a low clamping voltage of $<70\text{V}$.

The μ Clamp3603T is in a 6-pin SLP1710N6T package. It measures 1.7 x 1.0 x 0.4mm. The leads are spaced at a pitch of 0.55mm and are finished with lead-free NiPdAu. Each device will protect three lines operating at 36 volts. The small size and unique features of the μ Clamp3603T make it ideal for protection of DC high-side and low-side 3 wire proximity switches in industrial and automotive applications.

The μ Clamp3603T is qualified to AEC-Q100 Grade 1 for Automotive use.

Features

- ◆ Transient protection for proximity sensors.
 - IEC 61000-4-2 (ESD)
 - IEC 61000-4-4 (EFT)
- ◆ Ultra-small package (1.7 x 1.0 x 0.4mm)
- ◆ Protects one three line sensor.
- ◆ Low clamping voltage
- ◆ High operating voltage: 36V
- ◆ Solid-state silicon-avalanche technology
- ◆ AEC-Q100 Grade 1 Qualified

Mechanical Characteristics

- ◆ SLP1710N6T package
- ◆ Molding compound flammability rating: UL 94V-0
- ◆ Packaging : Tape and Reel
- ◆ Lead Finish: NiPdAu
- ◆ Pb-Free, Halogen Free, RoHS/WEEE Compliant

Applications

- ◆ Two and Three Wire DC High-Side and Low-Side Proximity Switches
- ◆ Digital Sensor Input Protection
- ◆ Industrial Controls
- ◆ 24V - 36V DC Supply Protection
- ◆ Automotive Applications

Package Dimensions

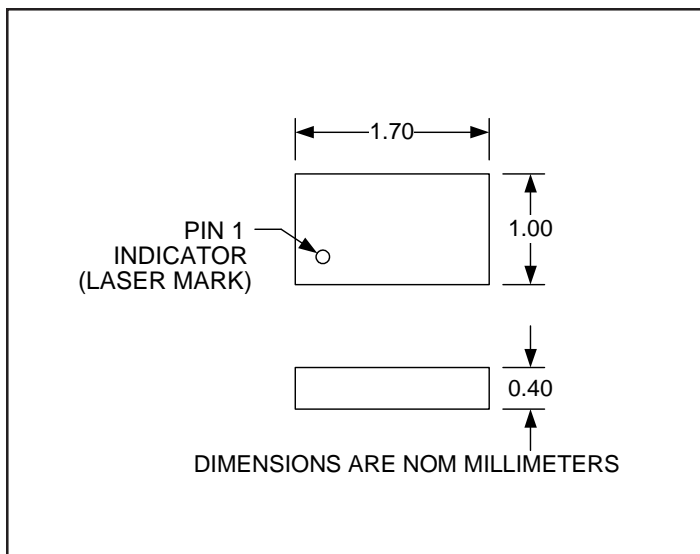

Schematic & Pin Configuration

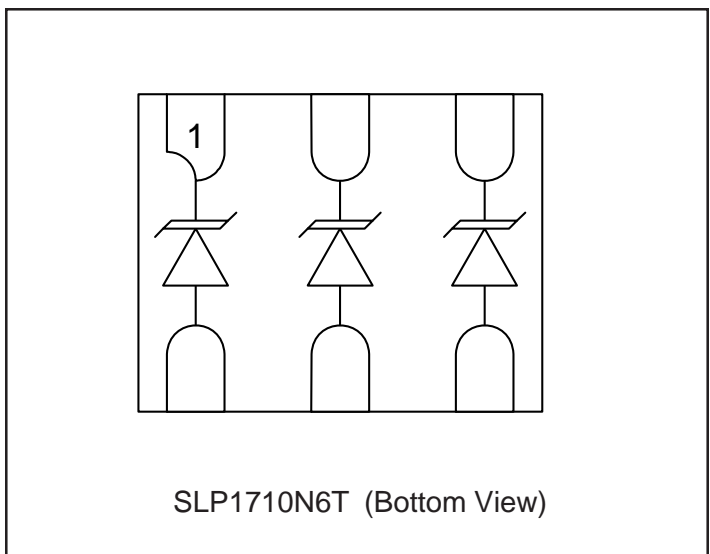

PROTECTION PRODUCTS

Absolute Maximum Ratings

Rating	Symbol	Value	Units
Peak Pulse Power (tp = 1.2/50µs)	P_{pk}	140	W
Peak Pulse Current (tp = 1.2/50µs)	I_{pp}	2	A
Maximum Steady State Forward Current ⁽¹⁾	I_F	200	mA
ESD per IEC 61000-4-2 (Air) ⁽²⁾ ESD per IEC 61000-4-2 (Contact) ⁽²⁾	V_{ESD}	+/- 20 +/- 15	kV
Operating Temperature	T_J	-40 to +125	°C
Storage Temperature	T_{STG}	-55 to +150	°C

Notes

(1): If multiple diodes conduct in the forward direction at any instant, the sum of the currents must not exceed this rating.

(2): ESD Gun return path to Ground Reference Plane (GRP)

Electrical Characteristics (T=25°C unless otherwise specified)

Parameter	Symbol	Conditions	Minimum	Typical	Maximum	Units
Reverse Stand-Off Voltage	V_{RWM}				36	V
Reverse Breakdown Voltage	V_{BR}	$I_t = 1mA; T = -40°C to 125°C$	37	43.5	55	V
Reverse Leakage Current	I_R	$V_{RWM} = 36V$	T=25°C	0.01	1	µA
			T=125°C	0.5	3	
Forward Voltage Drop	V_F	$I_F = 200mA$			1.0	V
Clamping Voltage	V_C	$I_{pp} = 2A, tp = 1.2/50µs$			70	V
Junction Capacitance	C_j	$V_R = 0V, f = 1MHz$	T=25°C	25	50	pF
			T=125°C	50	100	

Non-Repetitive Peak Pulse Power vs. Pulse Time

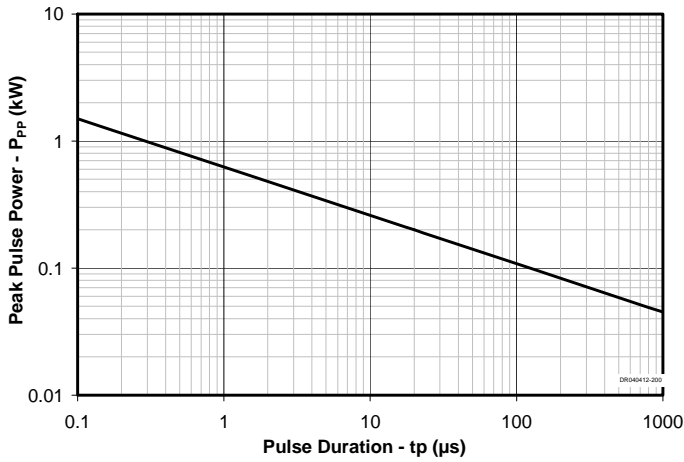

Power Derating Curve

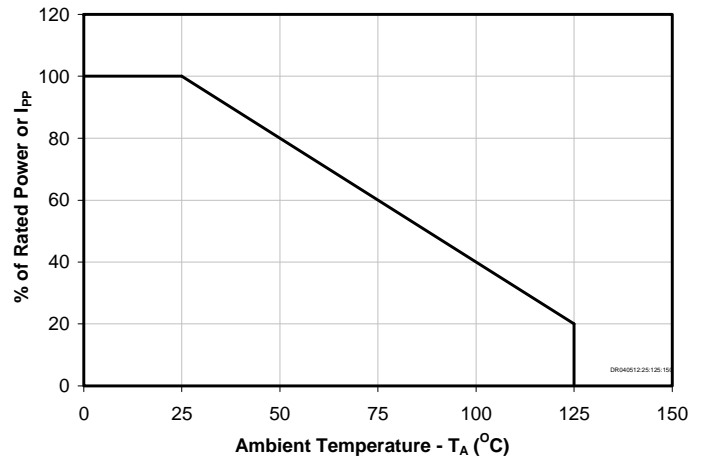

Clamping Voltage vs. Peak Pulse Current

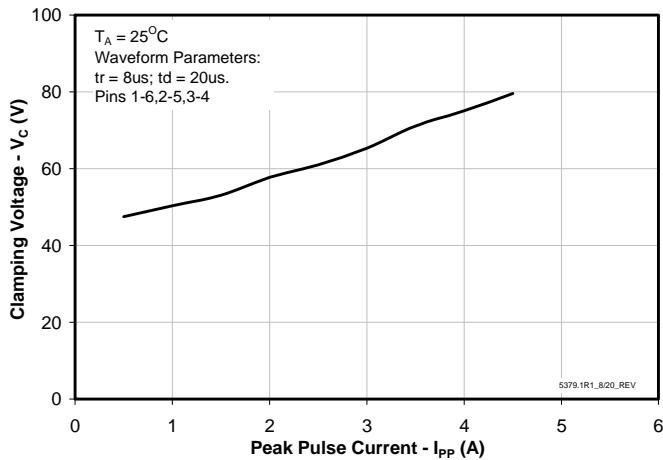

Junction Capacitance vs. Reverse Voltage

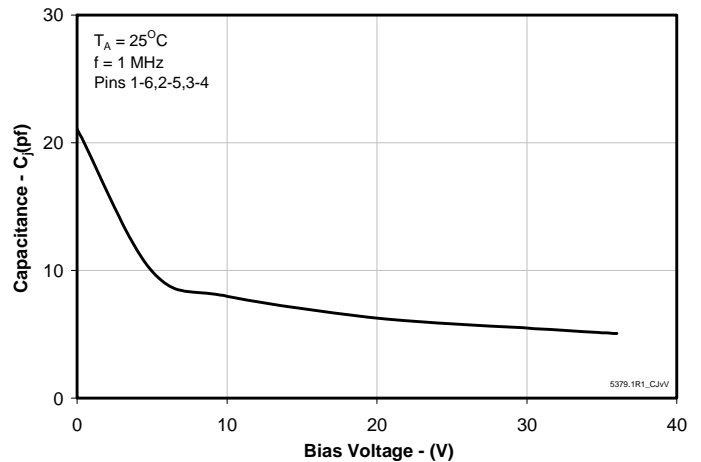

Forward Voltage vs. Forward Current

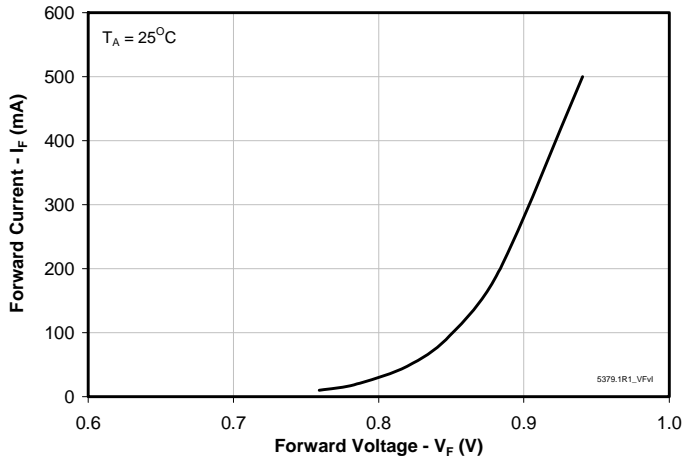

Forward Voltage vs. Temperature

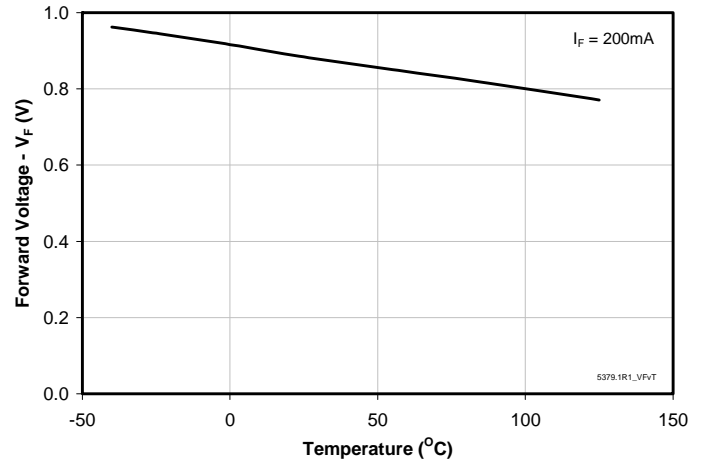

PROTECTION PRODUCTS

Typical Characteristics

Breakdown Voltage vs Temperature

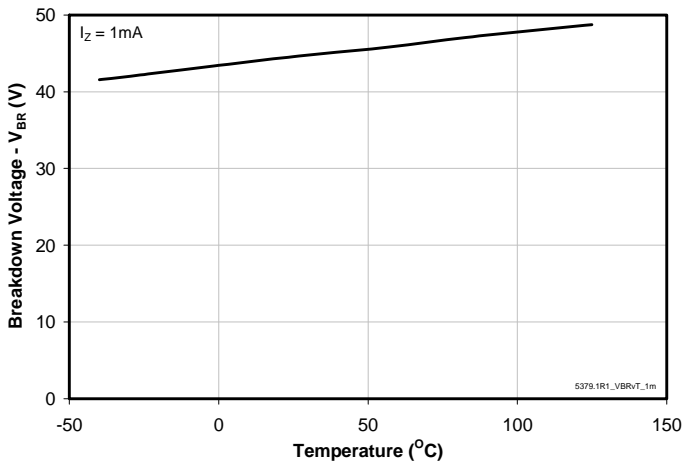

Reverse Leakage Current vs Temperature

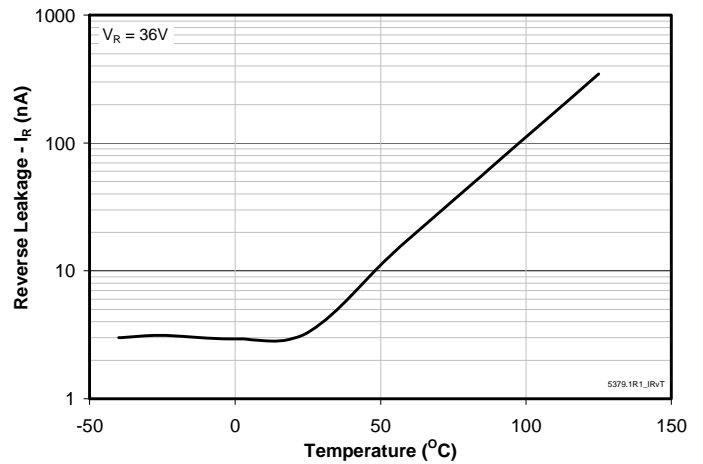

**Positive ESD Clamping
(8kV Contact per IEC 61000-4-2)**

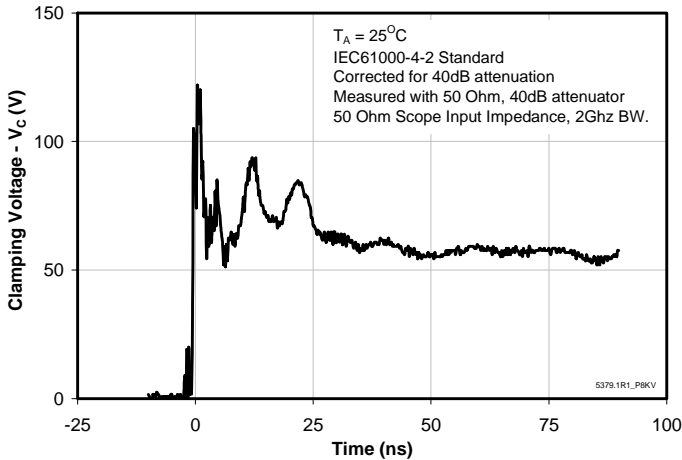

**Negative ESD Clamping
(8kV Contact per IEC 61000-4-2)**

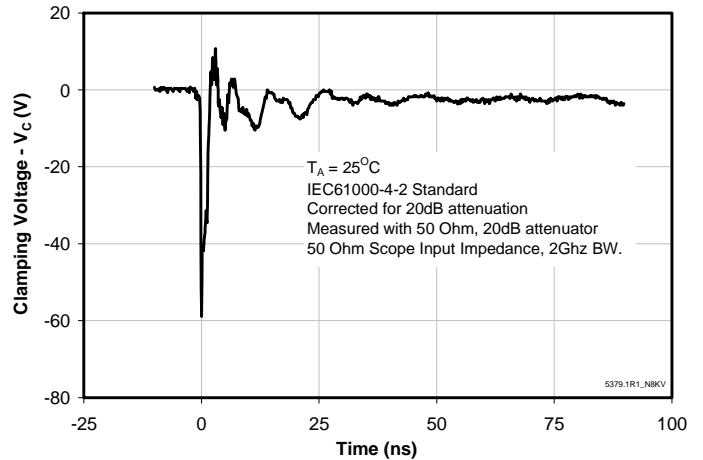

Junction Capacitance vs. Temperature at $V_R = 0\text{V}$

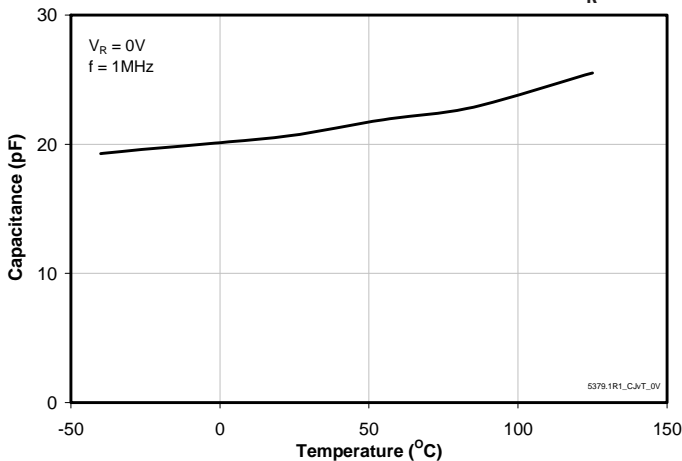

Junction Capacitance vs. Temperature at $V_R = 36\text{V}$

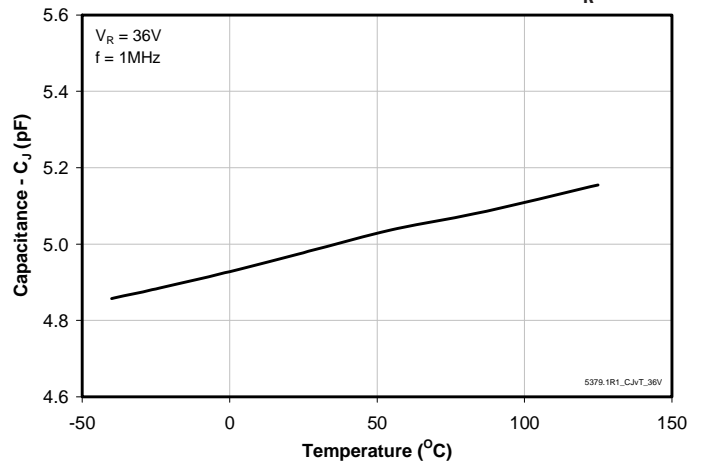

PROTECTION PRODUCTS

Applications Information

Device Connection for Protection of Two and Three Wire Proximity Switches

Digital sensors help to bridge the gap between the physical world and the digital world in applications such as computer controlled factory automation, automotive spark timing and throttle position sensing amongst others. In such environments, transient voltages can easily disrupt or damage sensitive sensor inputs. The uClamp3603T provides transient voltage protection for the digital sensors to ensure their operation is not disrupted by the physical world.

The uClamp3603T is designed to meet the high surge capability and low clamping voltage needed to protect the ASIC and control logic used in proximity switches. The uClamp3603T provides protection for the power and I/O lines. Typical configurations for the protection of two and three wire switches are illustrated:

Circuit Board Layout Recommendations for Suppression of ESD.

Good circuit board layout is critical for the suppression of ESD induced transients. The following guidelines are recommended:

- ◆ Place the TVS near the input terminals or connectors to restrict transient coupling.
- ◆ Minimize the path length between the TVS and the protected line.
- ◆ Minimize all conductive loops including power and ground loops.
- ◆ The ESD transient return path to ground should be kept as short as possible.
- ◆ Never run critical signals near board edges.
- ◆ Use ground planes whenever possible.

Equivalent Circuit Diagram

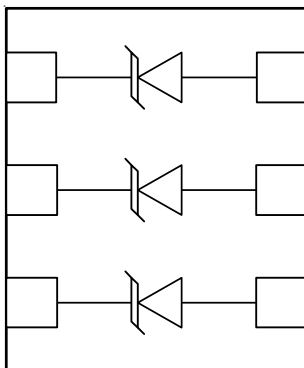

2-Wire DC Proximity Switch Application

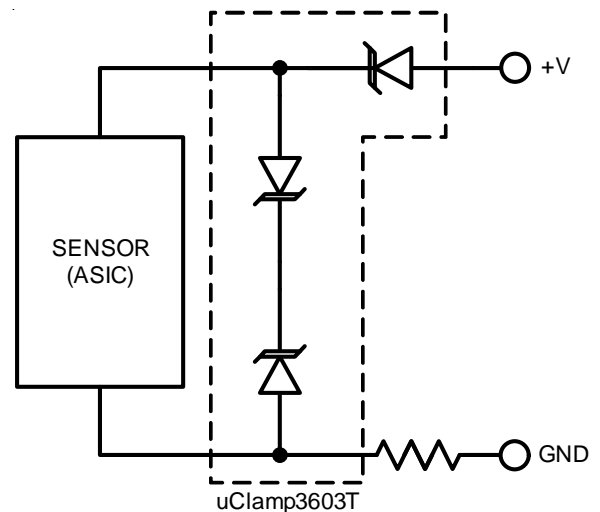

3-Wire DC Proximity Switch Application

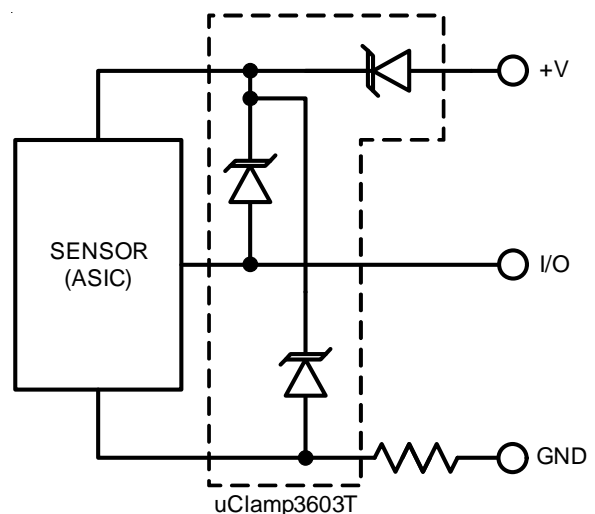

PROTECTION PRODUCTS

Outline Drawing - SLP1710N6T

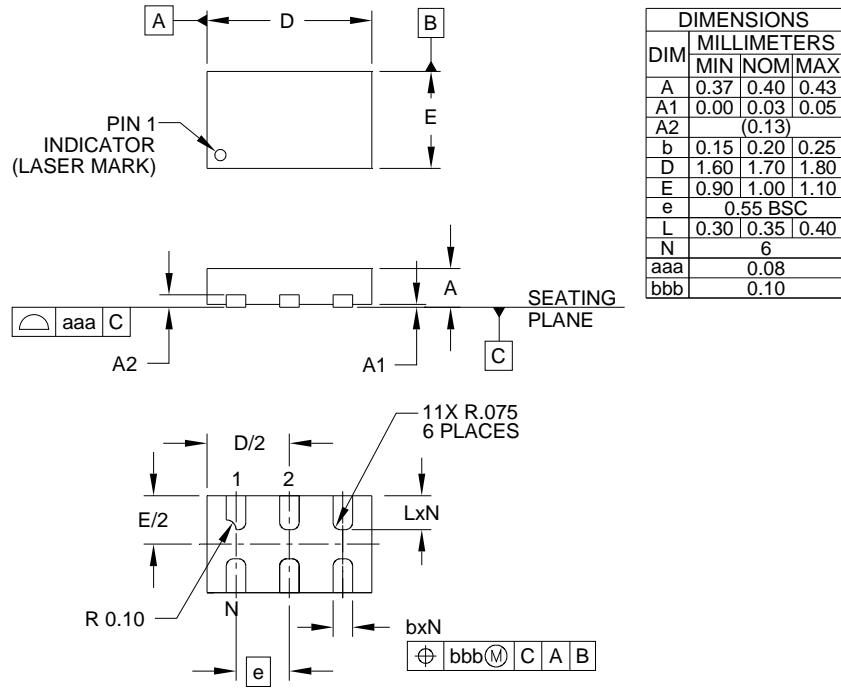

NOTES:
 1. CONTROLLING DIMENSIONS ARE IN MILLIMETERS (ANGLES IN DEGREES).

Land Pattern - SLP1710N6T

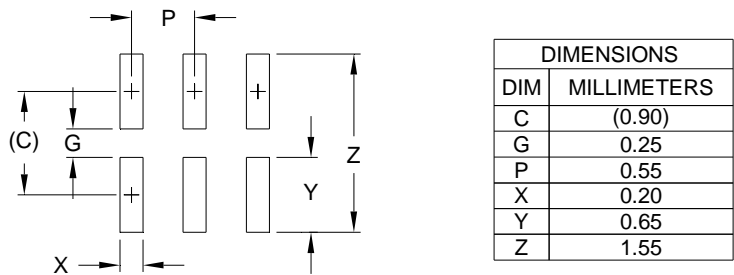

NOTES:
 1. CONTROLLING DIMENSIONS ARE IN MILLIMETERS (ANGLES IN DEGREES).
 2. THIS LAND PATTERN IS FOR REFERENCE PURPOSES ONLY.
 CONSULT YOUR MANUFACTURING GROUP TO ENSURE YOUR COMPANY'S MANUFACTURING GUIDELINES ARE MET.

PROTECTION PRODUCTS

Marking



YYWW = Date Code

Ordering Information

Part Number	Working Voltage	Qty per Reel	Reel Size
uClamp3603T.TCT	36V	3,000	7 Inch

Note: Lead finish is lead-free NiPdAu.
MicroClamp and uClamp are marks of Semtech Corporation.

Tape and Reel Specification

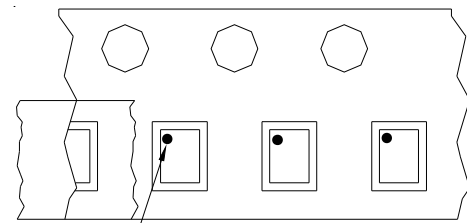
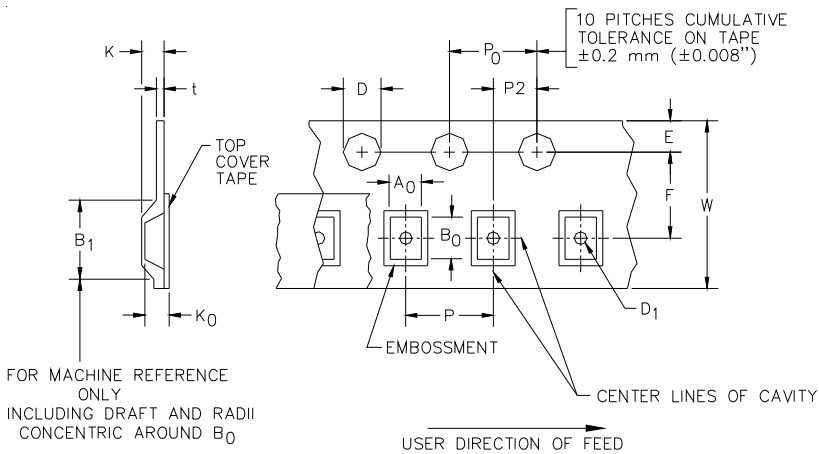

Pin 1 Location

→
User Direction of feed

Device Orientation in Tape
Pin 1 in upper left towards sprocket holes

A0	B0	K0
1.18 +/-0.05 mm	1.88 +/-0.05 mm	0.53 +/-0.05 mm

Tape Width	B, (Max)	D	D1	E	F	K (MAX)	P	P0	P2	T(MAX)	W
8 mm	4.2 mm	1.5 + 0.1 mm - 0.0 mm)	0.5 mm ±0.05	1.750±.10 mm	3.5±0.05 mm	2.4 mm	4.0±0.1 mm	4.0±0.1 mm	2.0±0.05 mm	0.4 mm	8.0 mm + 0.3 mm - 0.1 mm

Contact Information

Semtech Corporation
Protection Products Division
200 Flynn Rd., Camarillo, CA 93012
Phone: (805)498-2111 FAX (805)498-3804