

NON-ISOLATED DC/DC CONVERTERS

5 Vdc - 13.8 Vdc Input 0.6 Vdc - 5.0 Vdc/60 A Output



Mar. 23, 2010

Bel Power Inc., a subsidiary of Bel Fuse Inc.

VRP3-60E1A0

RoHS Compliant

Rev.D

Features

- Non-Isolated
- High Efficiency
- Fixed Switching Frequency
- Low Cost
- Excellent Thermal Performance
- Wide Input Voltage Range
- Wide Output Trim Range
- Output Over-Voltage Shutdown
- OCP/SCP
- Low Output Ripple
- Power Good Signal
- Remote On/Off



Applications

- Networking
- Computers and peripherals
- Telecommunications

Description

The VRP3-60E1A0 is a non-isolated dc/dc converter that operates over a wide range of input voltage ($V_{in} = 5 \text{ Vdc} - 13.8 \text{ Vdc}$). This unit can provide a precisely regulated output voltage from 0.6 Vdc to 5.0 Vdc and can deliver up to 60 A of output current. This unit is designed to be highly efficient and low cost. The converter is provided in an industry standard package.

Part Selection

Output Voltage	Input Voltage	Max. Output Current	Max. Output Power	Typical Efficiency ($V_o=1.8 \text{ Vdc}$)	Model Number Active High
0.6 Vdc - 5.0 Vdc	5 Vdc - 13.8 Vdc	60 A	300 W	88%	VRP3-60E1A0

Note: Add "G" suffix at the end of the model numbers listed above to indicate "Tray Packaging".

Part Number Explanation

V R P3 - 60 E 1A 0
1 2 3 4 5 6 7

- 1---Vertical mount
- 2---RoHS 6, change "R" to "7" means RoHS 5
- 3---Series name (SIP)
- 4---Series code (output current 60A)
- 5---Input range (5-13.8V)
- 6---Output voltage (0.6-5.0V)
- 7---Suffix

NON-ISOLATED DC/DC CONVERTERS

5 Vdc - 13.8 Vdc Input 0.6 Vdc - 5.0 Vdc/60 A Output



Mar. 23, 2010

Bel Power Inc., a subsidiary of Bel Fuse Inc.

Absolute Maximum Ratings

Parameter	Min	Typ	Max	Notes
Input Voltage (continuous)	-0.3 V	-	15 V	
Output Enable Terminal Voltage	-0.3 V	-	15 V	
Ambient Temperature	0 °C	-	70 °C	
Storage Temperature	-55 °C	-	125 °C	

Input Specifications

Parameter	Min	Typ	Max	Notes
Input Voltage				
$V_o \leq 2.8 \text{ V}$	5 V	12 V	13.8 V	
$V_o > 2.8 \text{ V}$	$1.8 \cdot V_o$	12 V	13.8 V	
Input Current (full load)	-	-	40 A	
Input Reflected Ripple Current (pk-pk)	-	20	35	With simulated source impedance of 1 uH, 5 Hz to 20 MHz. Use a 1000 uF/16 V electrolytic capacitor with ESR=0.1 ohm max, at 100 kHz at 25°C.
Input Reflected Ripple Current (rms)	-	5	10	
I^2t Inrush Current Transient	-	-	1 A ² s	
Turn-on Voltage Threshold	-	4.6 V	4.8 V	
Under Voltage Threshold	-	4.3 V	4.5 V	

Note: All specifications are typical at 25 °C unless otherwise stated.

Output Specifications

Parameter	Min	Typ	Max	Notes
Output Voltage Set Point				
$V_o \geq 1 \text{ V}$	-1.5 % V_o	-	+1.5 % V_o	$V_{in} = V_{inmin}$, $I_o = I_{omax}$
$V_o < 1 \text{ V}$	-10 mV	-	+10 mV	
Load Regulation				
$V_o \geq 2.5 \text{ V}$	-	-	0.6% V_o	
$V_o < 2.5 \text{ V}$	-	-	12 mV	
Line Regulation				
$V_o \geq 2.5 \text{ V}$	-	-	0.3% V_o	
$V_o < 2.5 \text{ V}$	-	-	9 mV	
Regulation Over Temperature (0 °C to +70 °C)	-	-	0.02% V_o/C	
Output Current	0 A	-	60 A	
Current Limit Threshold	110% I_o	130% I_o	160% I_o	
Output Ripple and Noise (pk-pk)				
$V_o = 5.0 \text{ V}$	-	-	60 mV	Test conditions: 0-20 MHz BW, with a 1 μ F ceramic capacitor and a 10 uF Tantalum cap at output.
$V_o = 3.3 \text{ V}$	-	-	60 mV	
$V_o = 2.5 \text{ V}$	-	-	40 mV	
$V_o = 1.5 \text{ V}$	-	-	40 mV	
$V_o = 1.0 \text{ V}$	-	-	30 mV	
$V_o = 0.6 \text{ V}$	-	-	30 mV	

NON-ISOLATED DC/DC CONVERTERS

5 Vdc - 13.8 Vdc Input 0.6 Vdc - 5.0 Vdc/60 A Output



Mar. 23, 2010

Bel Power Inc., a subsidiary of Bel Fuse Inc.

Output Specifications (continued)

Parameter	Min	Typ	Max	Notes	
Output Ripple and Noise (rms)				Test conditions: 0-20 MHz BW, with a 1 μ F ceramic capacitor and a 10 μ F Tantalum cap at output.	
Vo=5.0 V	-	-	30 mV		
Vo=3.3 V	-	-	30 mV		
Vo=2.5 V	-	-	20 mV		
Vo=1.5 V	-	-	20 mV		
Vo=1.0 V	-	-	15 mV		
Vo=0.6 V	-	-	15 mV		
Turn On Time	-	-	10 mS		
Rise Time	-	-	3 mS		
Overshoot at Turn on and off	-	-	0.5%		
Output Capacitance					
ESR \geq 1 m Ω	0 μ F	-	4700 μ F		
Transient Response					
0% ~ 50% Max Load	Vo=All	-	-	300 mV	Test conditions: di/dt = 10 A/ μ S; Vin = 12 V;
Settling Time		-	-	100 μ S	
50% ~ 0% Max Load		-	-	300 mV	
Settling Time		-	-	100 μ S	

Note: All specifications are typical at 25 °C unless otherwise stated.

General Specifications

Parameter	Min	Typ	Max	Notes
Efficiency				Measured at Vin=12 V, full load.
Vo=5.0 V	91%	94%	-	
Vo=3.3 V	89%	91%	-	
Vo=2.5 V	87%	90%	-	
Vo=1.8 V	84%	88%	-	
Vo=1.5 V	82%	87%	-	
Vo=1.2 V	79%	84%	-	
Vo=1.0 V	76%	81%	-	
Vo=0.6 V	68%	74%	-	
Switching Frequency	-	333 kHz	-	
Output Voltage Trim Range	0.6 V	-	5 V	Trim pin is open, Vo = 0.6 V.
Over Voltage Protection	110% Vo,set	115%Vo,set	130%Vo,set	Vin=12 V, Io=full load.
MTBF	2,576,000 hours			Calculated Per Bell Core SR-332 (Io = 80%Iomax; Vin=12 V; Ta = 25 °C)
Dimensions				
Inches (L x W x H)	2.58 x 1.25 x 0.608			
Millimeters (L x W x H)	65.53 x 31.75 x 15.44			
Weight	-	38 g	-	

Note: All specifications are typical at 25 °C unless otherwise stated.

NON-ISOLATED DC/DC CONVERTERS

5 Vdc - 13.8 Vdc Input 0.6 Vdc - 5.0 Vdc/60 A Output



Mar. 23, 2010

Bel Power Inc., a subsidiary of Bel Fuse Inc.

Control Specifications

Parameter	Min	Typ	Max	Notes
Remote On/Off (Active High)				
Signal Low (Unit Off)	-0.3 V	-	0.8 V	Remote On/Off pin is open, unit is off.
Signal High (Unit On)	2 V	-	V _{in,max}	
Current Source/Sink	0 mA	-	3.3 mA	
PwGood (PowerGood)				
PwGood = High = Power Good	2.4 V	-	5.25 V	
	-	-	2 mA	
PwGood = Low = Power Not Good	0 V	-	0.4 V	
	-	-	4 mA	

Output Trim Equation

The Trim resistor should be connected between the Trim+ pin and Trim- pin.

$$R_{trim} = \frac{1.2}{V_o - 0.6} (K\Omega)$$

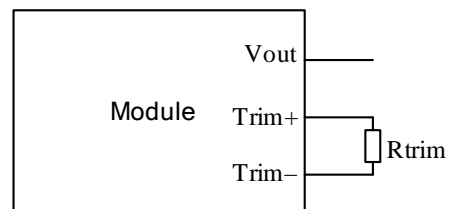

NON-ISOLATED DC/DC CONVERTERS

5 Vdc - 13.8 Vdc Input

0.6 Vdc - 5.0 Vdc/60 A Output



Mar. 23, 2010

Bel Power Inc., a subsidiary of Bel Fuse Inc.

Efficiency Data

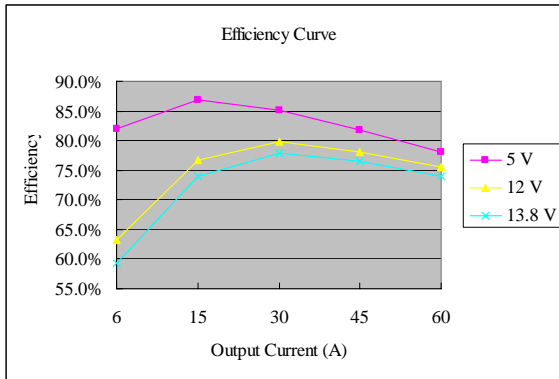

V_{out} = 0.6 V

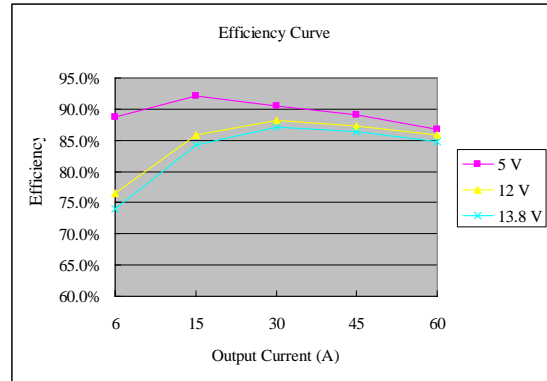

V_{out} = 1.2 V

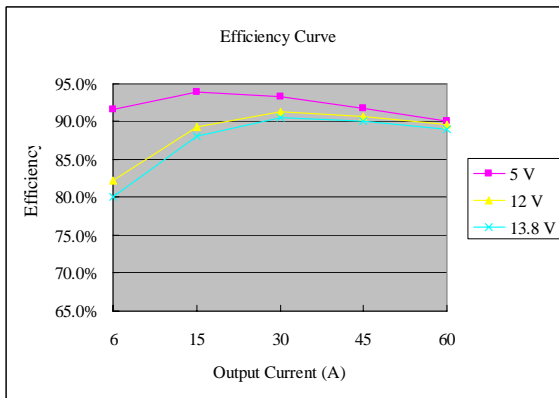

V_{out} = 1.8 V

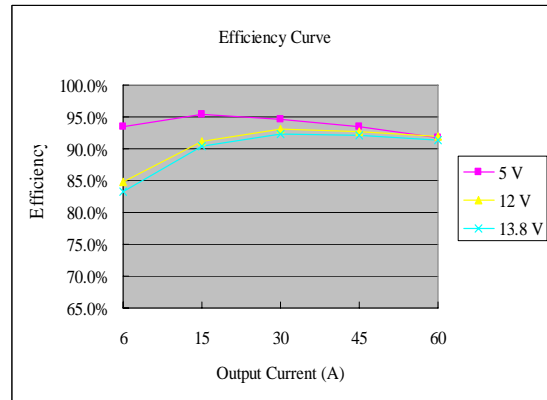

V_{out} = 2.5 V

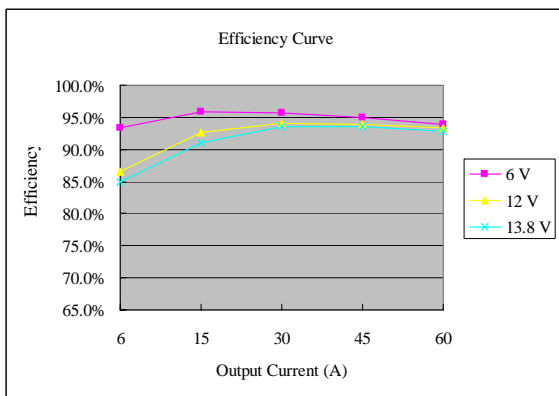

V_{out} = 3.3 V

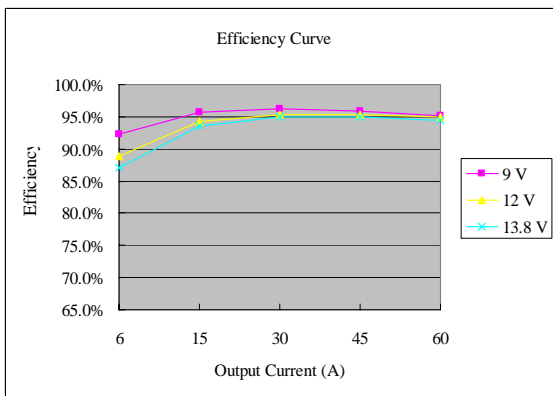

V_{out} = 5.0 V

NON-ISOLATED DC/DC CONVERTERS

5 Vdc - 13.8 Vdc Input

0.6 Vdc - 5.0 Vdc/60 A Output



Mar. 23, 2010

Bel Power Inc., a subsidiary of Bel Fuse Inc.

Thermal Derating Curves

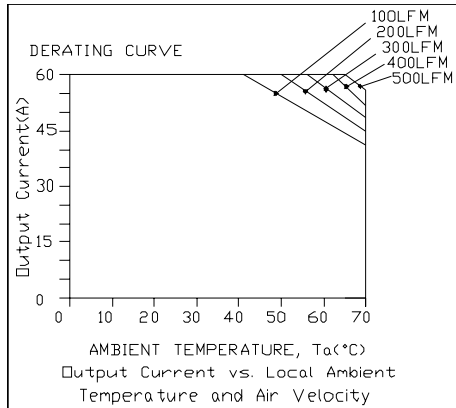

Vin=12 V, Vo=0.6 V

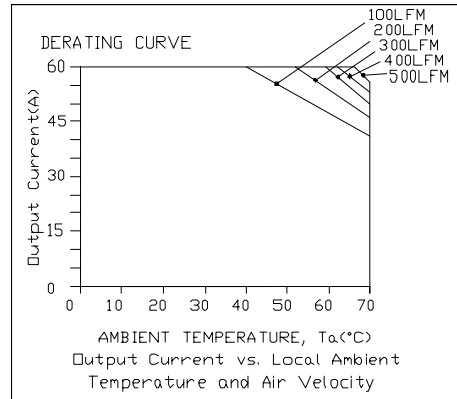

Vin=12 V, Vo=1.2 V

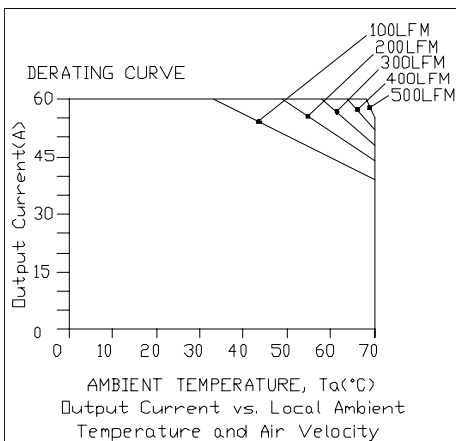

Vin=12 V, Vo=1.8 V

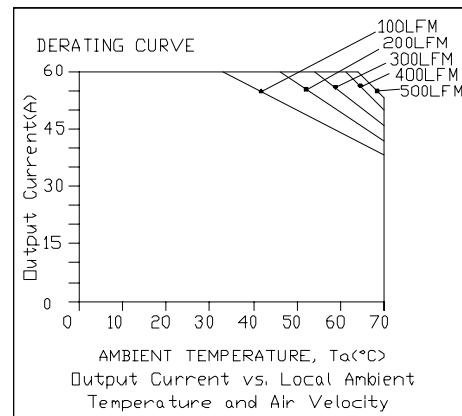

Vin=12 V, Vo=2.5 V

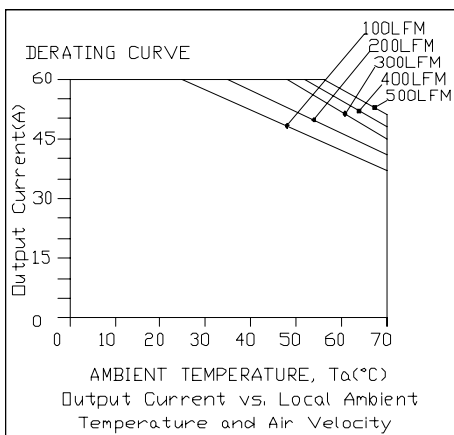

Vin=12 V, Vo=3.3 V

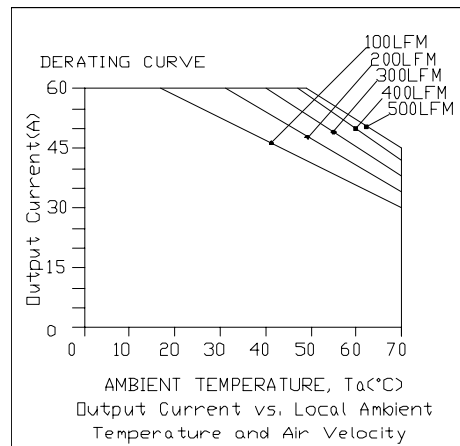

Vin=12 V, Vo=5.0 V

NON-ISOLATED DC/DC CONVERTERS

5 Vdc - 13.8 Vdc Input

0.6 Vdc - 5.0 Vdc/60 A Output



Mar. 23, 2010

Bel Power Inc., a subsidiary of Bel Fuse Inc.

Ripple and Noise Waveforms

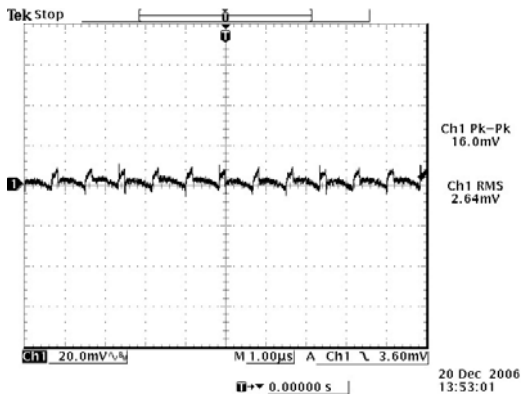

12 Vdc input, 0.6 Vdc/60 A output

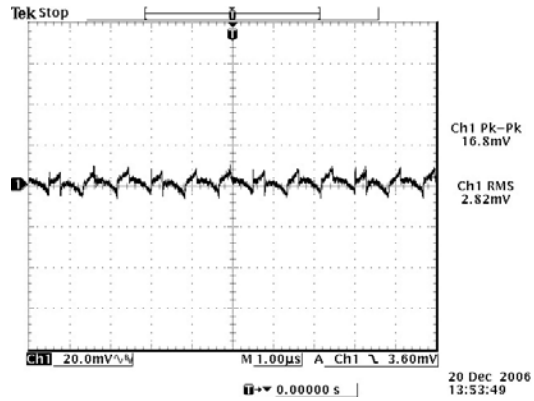

12 Vdc input, 1.2 Vdc/60 A output

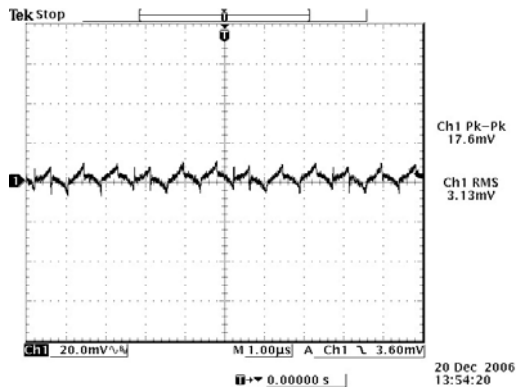

12 Vdc input, 1.8 Vdc/60 A output

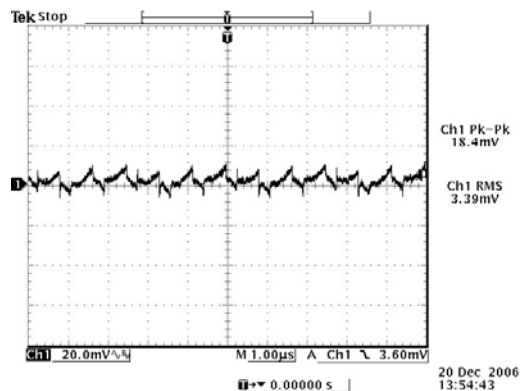

12 Vdc input, 2.5 Vdc/60 A output

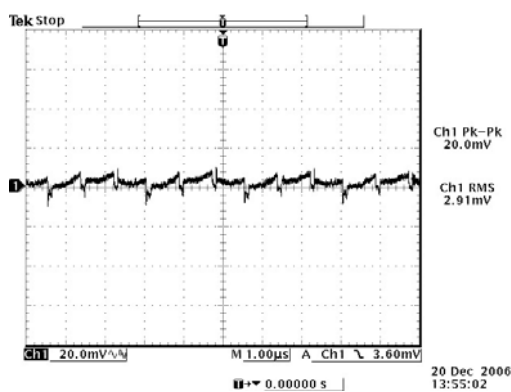

12 Vdc input, 3.3 Vdc/60 A output

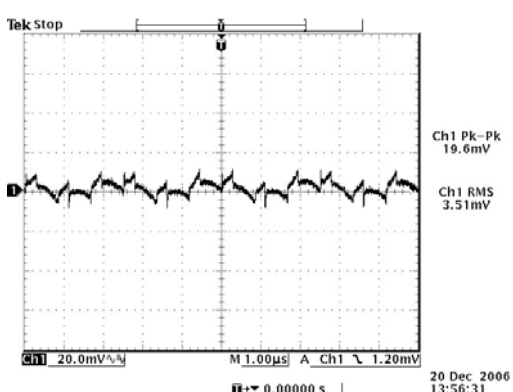

12 Vdc input, 5.0 Vdc/60 A output

Note: Ripple and noise at full load, 0-20 MHz BW, with a 10 uF tantalum cap and a 1uF ceramic cap at the output, and $T_a=25$ deg C.

NON-ISOLATED DC/DC CONVERTERS

5 Vdc - 13.8 Vdc Input

0.6 Vdc - 5.0 Vdc/60 A Output



Mar. 23, 2010

Bel Power Inc., a subsidiary of Bel Fuse Inc.

Transient Response Waveforms

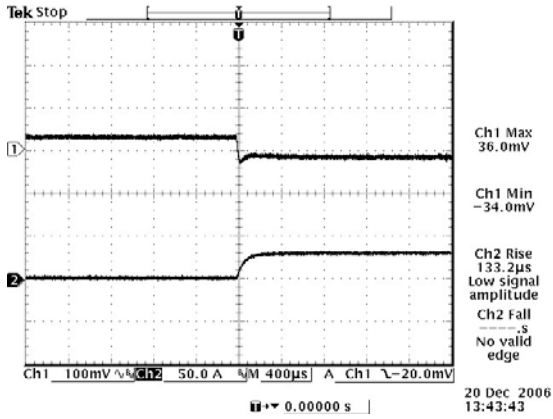

Vout=0.6 V 0%-50% Load Transients

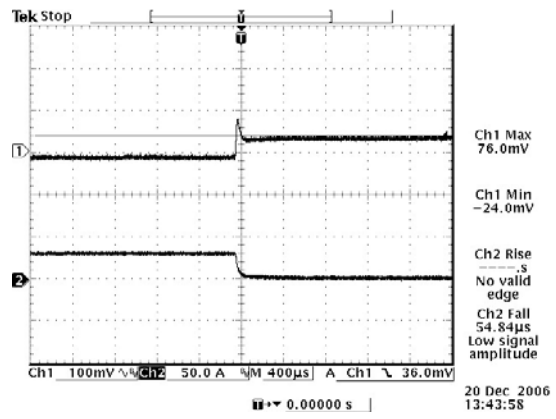

Vout=0.6 V 50%-0% Load Transients

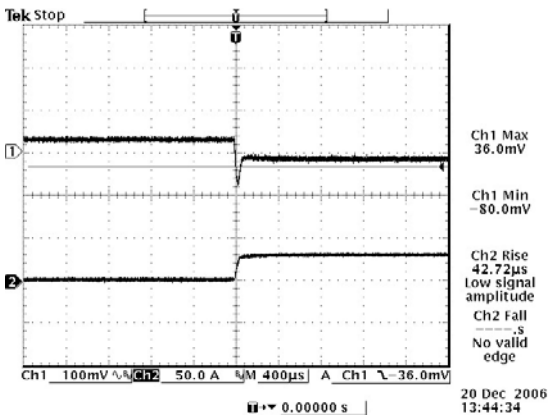

Vout=1.2 V 0%-50% Load Transients

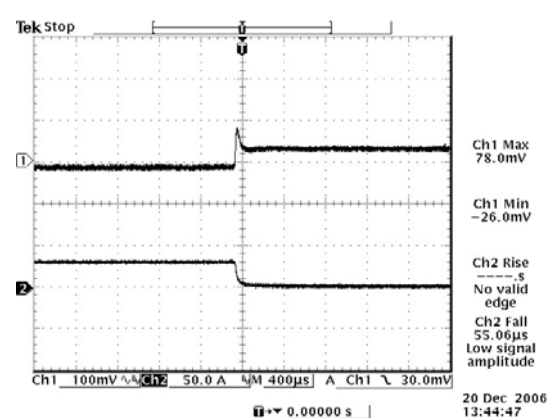

Vout=1.2 V 50%-0% Load Transients

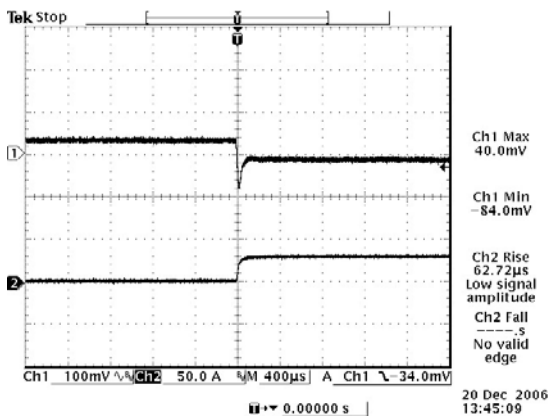

Vout=1.8 V 0%-50% Load Transients

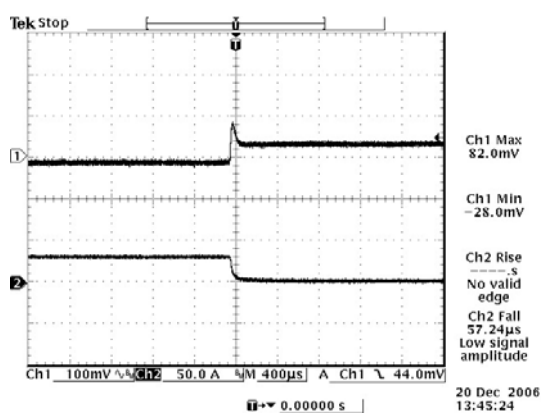

Vout=1.8 V 50%-0% Load Transients

NON-ISOLATED DC/DC CONVERTERS

5 Vdc - 13.8 Vdc Input

0.6 Vdc - 5.0 Vdc/60 A Output



Mar. 23, 2010

Bel Power Inc., a subsidiary of Bel Fuse Inc.

Transient Response Waveforms (continued)

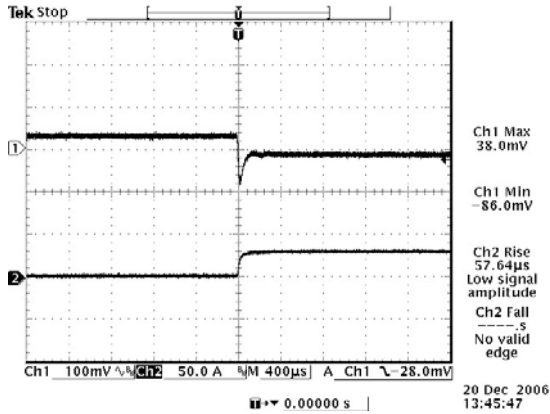

Vout= 2.5 V 0%-50% Load Transients

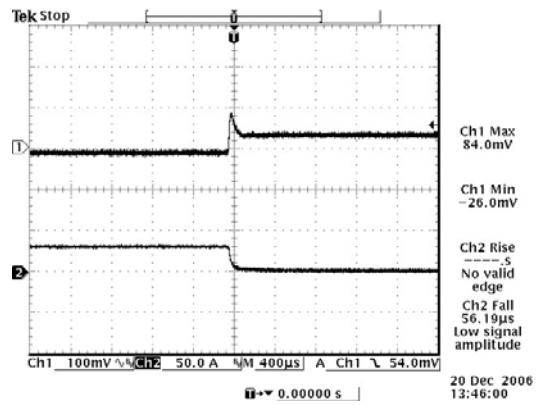

Vout=2.5 V 50%-0% Load Transients

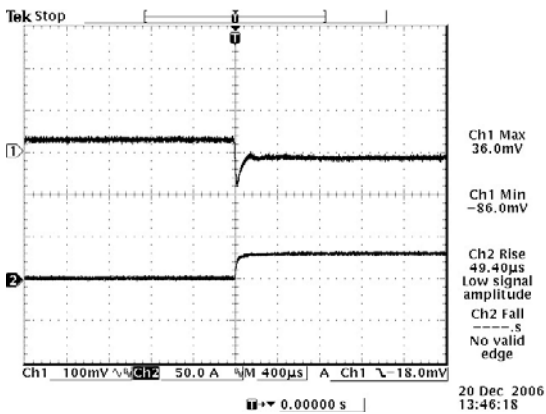

Vout=3.3 V 0%-50% Load Transients

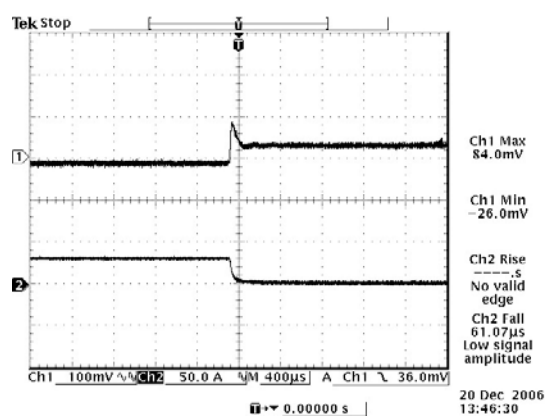

Vout=3.3 V 50%-0% Load Transients

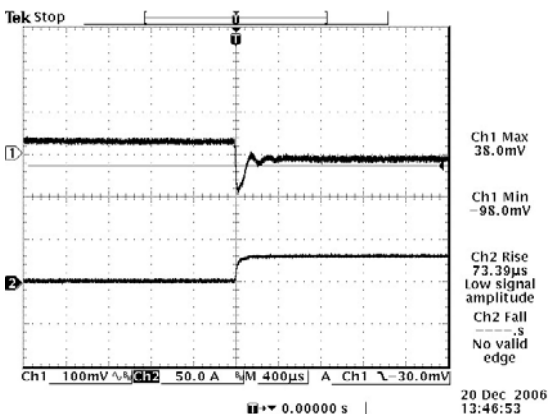

Vout=5 V 0%-50% Load Transients

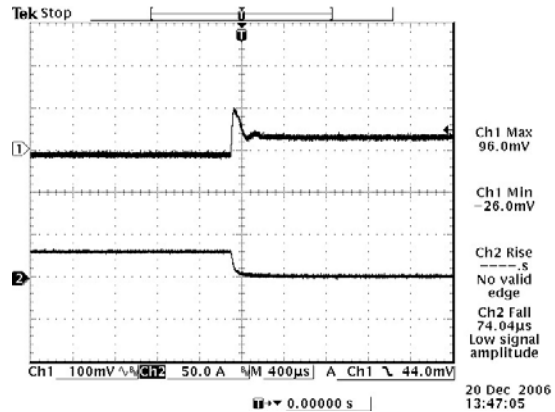

Vout=5 V 50%-0% Load Transients

Note: Transient response at $di/dt = 10 \text{ A}/\mu\text{s}$, with external electrolytic cap 4700 μF , and $T_a=25 \text{ deg C}$.

NON-ISOLATED DC/DC CONVERTERS

5 Vdc - 13.8 Vdc Input

0.6 Vdc - 5.0 Vdc/60 A Output



Mar. 23, 2010

Bel Power Inc., a subsidiary of Bel Fuse Inc.

Mechanical Outline

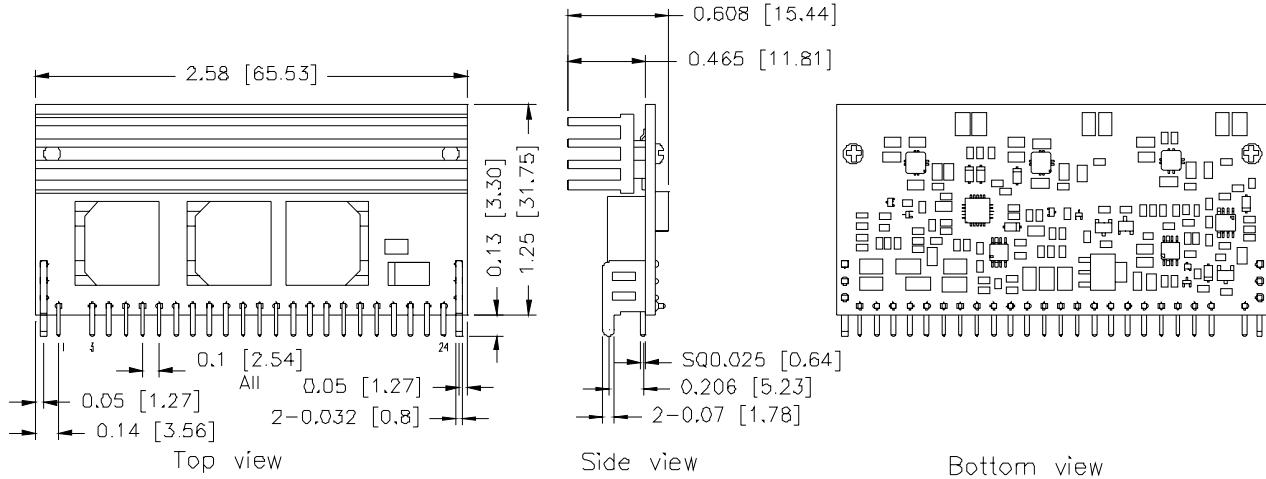

RECOMMENDED PAD LAYOUT

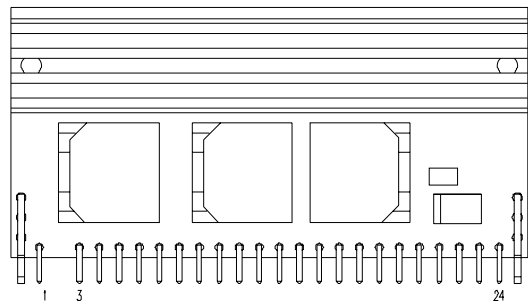
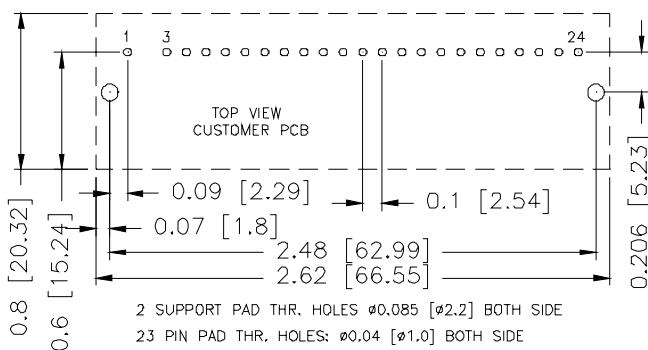

Pin Connections

Pin	Function	Pin	Function	Pin	Function
1	Trim+	9	Enable	17	GND
2	N/A	10	Sense-	18	Vout
3	GND	11	Sense+	19	GND
4	PwGOOD	12	Vin	20	Vout
5	Trim-	13	Vin	21	GND
6	Ishare	14	Vin	22	Vout
7	GND	15	Vout	23	GND
8	GND	16	Vout	24	Vout

Note: This module is recommended and compatible with Pb-Free Wave Soldering and must be soldered using a peak solder temperature of no more than 260 °C for less than 5 seconds.

Note:

- 1) All Pins: Material - Copper Alloy;
Finish – 3 micro inches minimum Gold over 50 micro inches minimum Nickel plate.
- 2) Undimensioned components are shown for visual reference only.
- 3) All dimensions in inches (mm); Tolerances: x.xx +/-0.02 in. (x.x +/-0.5mm) x.xxx +/-0.010 in. (x.xx +/-0.25mm).

NON-ISOLATED DC/DC CONVERTERS

5 Vdc - 13.8 Vdc Input 0.6 Vdc - 5.0 Vdc/60 A Output



Mar. 23, 2010

Bel Power Inc., a subsidiary of Bel Fuse Inc.

Revision History

Date	Revision	Changes Detail	Approval
2010-3-23	D	1. Change to Bel new datasheet format	YF Sun

RoHS Compliance

Complies with the European Directive 2002/95/EC, calling for the elimination of lead and other hazardous substances from electronic products.



©2010 Bel Fuse Inc. Specifications subject to change without notice. 032310

CORPORATE

Bel Fuse Inc.
206 Van Vorst Street
Jersey City, NJ 07302
Tel 201-432-0463
Fax 201-432-9542
www.belfuse.com

FAR EAST

Bel Fuse Ltd.
8F/ 8 Luk Hop Street
San Po Kong
Kowloon, Hong Kong
Tel 852-2328-5515
Fax 852-2352-3706
www.belfuse.com

EUROPE

Bel Fuse Europe Ltd.
Preston Technology Management Centre
Marsh Lane, Suite G7, Preston
Lancashire, PR1 8UD, U.K.
Tel 44-1772-556601
Fax 44-1772-888366
www.belfuse.com