

# Cree® PLCC6 3 in 1 SMD LED

## QLS6A-FKW (with zener protection)

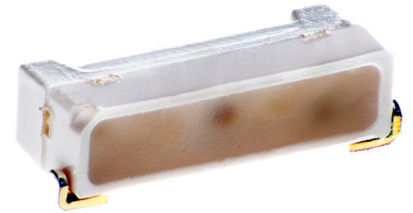

### PRODUCT DESCRIPTION

These SMD LEDs are packaged in an industry standard PLCC6 package. These high performance tricolor SMT LEDs are designed to work in a wide range of applications. A wide viewing angle and high brightness make these LEDs suitable for indoor signage applications.

### FEATURES

- Size (mm): 4.7 x 1.5 X1.3
- Dominant Wavelength (nm):  
Red:(619-624)  
Green:(520-540)  
Blue:(460-480)
- Luminous Intensity (mcd)  
(900-2800)
- Moisture Sensitivity Level: 3
- Lead-Free
- RoHS Compliant

### APPLICATIONS

- Full-Color Video Screen
- Decorative lighting
- Amusement

### ABSOLUTE MAXIMUM RATINGS ( $T_A = 25^\circ\text{C}$ )

Items	Symbol	Absolute Maximum Rating			Unit
		R	G	B	
Forward Current <sup>Note 1</sup>	$I_F$	30	20	20	mA
Peak Forward Current <sup>Note 2</sup>	$I_{FP}$	200	100	100	mA
Reverse Voltage	$V_R$	5	5	5	V
Power Dissipation	$P_D$	78	76	76	mW
Operation Temperature	$T_{opr}$	-40 ~ +85			$^\circ\text{C}$
Storage Temperature	$T_{stg}$	-40 ~ +100			$^\circ\text{C}$
Junction Temperature	$T_j$	110	110	110	$^\circ\text{C}$
Junction/ambient 1 chip on	$R_{THJA}$	360	475	450	$^\circ\text{C/W}$
Junction/solder point 1 chip on	$R_{THJS}$	200	330	300	$^\circ\text{C/W}$
Junction/ambient 3 chip on	$R_{THJA}$	510	675	690	$^\circ\text{C/W}$
Junction/solder point 3 chip on	$R_{THJS}$	280	470	420	$^\circ\text{C/W}$

**Note:** 1.Single-color light.  
2.Pulse width  $\leq 0.1$  msec, duty  $\leq 1/10$ .

### TYPICAL ELECTRICAL & OPTICAL CHARACTERISTICS ( $T_A = 25^\circ\text{C}$ )

Characteristics	Condition	Symbol	Values			Unit
			R	G	B	
Dominant Wavelength	$I_F = 14$ mA (R) $I_F = 12$ mA (G) $I_F = 16$ mA (B)	$\lambda_{DOM}$	619~624	520~540	460~480	nm
Spectral bandwidth at 50% $I_{REL}$ max	$I_F = 14$ mA (R) $I_F = 12$ mA (G) $I_F = 16$ mA (B)	$\Delta \lambda$				nm
Forward Voltage	$I_F = 14$ mA (R) $I_F = 12$ mA (G) $I_F = 16$ mA (B)	$V_{F(avg)}$	2.1	3.0	3.1	V
		$V_{F(max)}$	2.6	3.8	3.8	V
Luminous Intensity	$I_F = 14$ mA (R) $I_F = 12$ mA (G) $I_F = 16$ mA (B)	$I_{V(min)}$	900-2800			mcd
Reverse Current (max)	$V_R = 5$ V	$I_R$	10	10	10	$\mu\text{A}$

## INTENSITY BIN LIMIT (RED $I_F = 14\text{mA}$ , GREEN $I_F = 12\text{mA}$ , BLUE $I_F = 16\text{mA}$ )

Bin Code	Min. (mcd)	Max. (mcd)
NS	900	2800

## COLOR BIN LIMIT (RED $I_F = 14\text{mA}$ , GREEN $I_F = 12\text{mA}$ , BLUE $I_F = 16\text{mA}$ )

Bin Code	x	y
5A	0.2800	0.3200
	0.3100	0.3300
	0.3100	0.2950
	0.2800	0.2850
5B	0.3100	0.3300
	0.3400	0.3400
	0.3400	0.3050
	0.3100	0.2950
5C	0.3100	0.2950
	0.3400	0.3050
	0.3400	0.2700
	0.3100	0.2600
5D	0.2800	0.2850
	0.3100	0.2950
	0.3100	0.2600
	0.2800	0.2500
6A	0.2200	0.3100
	0.2500	0.3150
	0.2500	0.2800
	0.2200	0.2750
6B	0.2500	0.3150
	0.2800	0.3200
	0.2800	0.2850
	0.2500	0.2800
6C	0.2500	0.2800
	0.2800	0.2850
	0.2800	0.2500
	0.2500	0.2450
6D	0.2200	0.2750
	0.2500	0.2800
	0.2500	0.2450
	0.2200	0.2400

Bin Code	x	y
7A	0.2200	0.2400
	0.2500	0.2450
	0.2500	0.2100
	0.2200	0.2050
7B	0.2500	0.2450
	0.2800	0.2500
	0.2800	0.2150
	0.2500	0.2100
7C	0.2500	0.2100
	0.2800	0.2150
	0.2800	0.1800
	0.2500	0.1750
7D	0.2200	0.2050
	0.2500	0.2100
	0.2500	0.1750
	0.2200	0.1700
8A	0.2800	0.2500
	0.3100	0.2600
	0.3100	0.2250
	0.2800	0.2150
8B	0.3100	0.2600
	0.3400	0.2700
	0.3400	0.2350
	0.3100	0.2250
8C	0.3100	0.2250
	0.3400	0.2350
	0.3400	0.2000
	0.3100	0.1900
8D	0.2800	0.2150
	0.3100	0.2250
	0.3100	0.1900
	0.2800	0.1800

- Tolerance of measurement of the color coordinates is  $\pm 0.02$ .

## CIE CHROMATICITY DIAGRAM

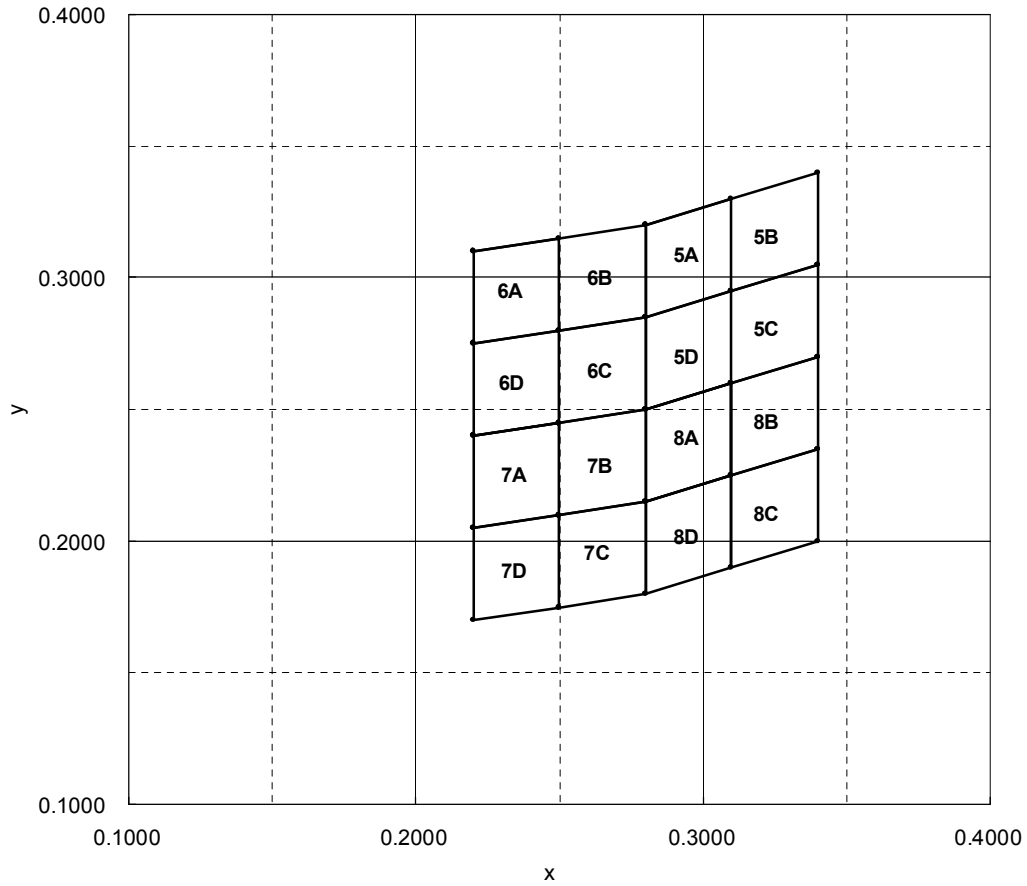

**ORDER CODE TABLE\***

Kit Number	Color	Luminous Intensity (mcd)		Dominant Wavelength (nm)	Package
		Min.	Max.		
QLS6A-FKW-CNSNSF043	RGB	900	2800	5A,5B,5C,5D,6A,6B,6C,6D, 7A,7B,7C,7D,8A,8B,8C,8D,	Reel

Notes:

1. The above kit numbers represent order codes that include multiple intensity-bin and color-bin codes. Only one intensity-bin code and one color-bin code will be shipped on each bulk. Single intensity-bin code and single color-bin codes will not be orderable.
2. Please refer to the "Cree LED Lamp Reliability Test Standards" document for reliability test conditions.
3. Please refer to the "Cree LED Lamp Soldering & Handling" document for information about how to use this LED product safely.

## GRAPHS

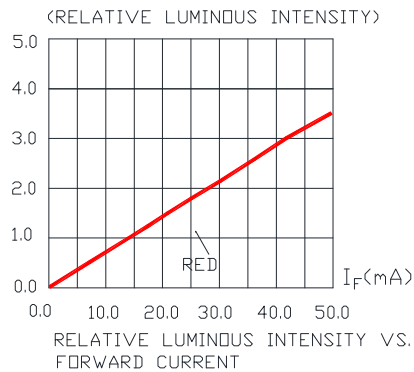
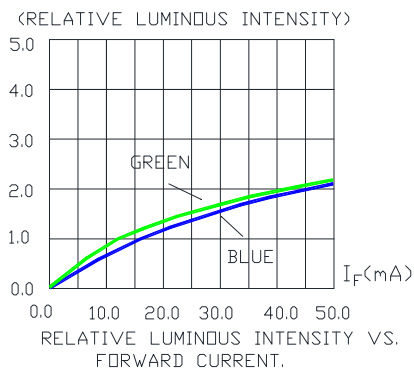
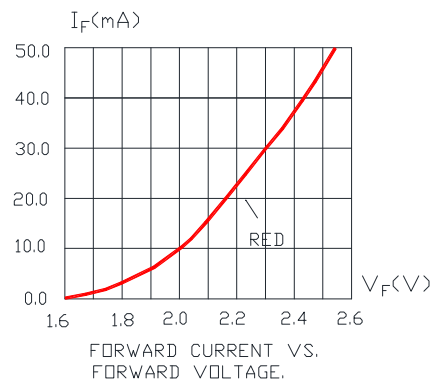
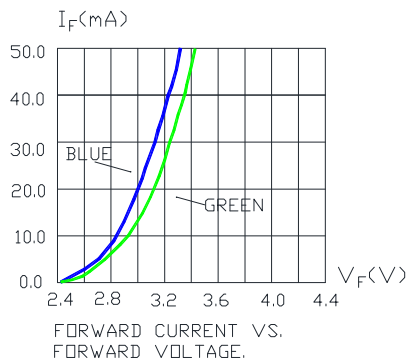
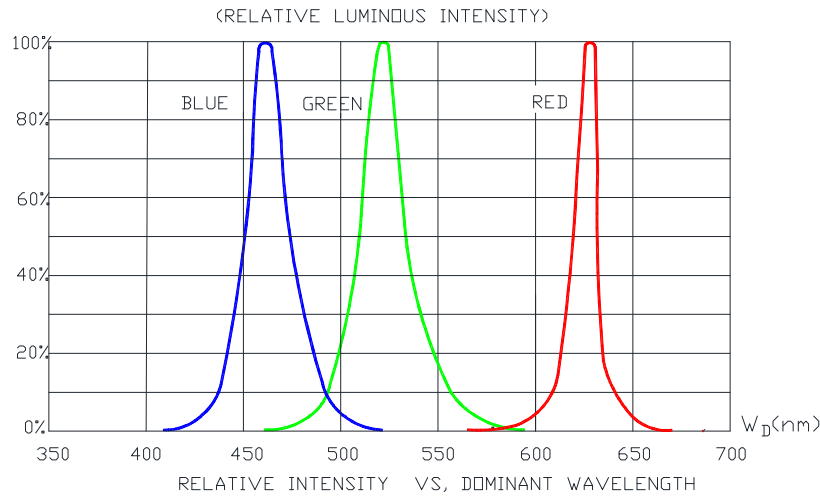

The above data are collected from statistical figures that do not necessarily correspond to the actual parameters of each single LED. Hence, these data will be changed without further notice.

## GRAPHS

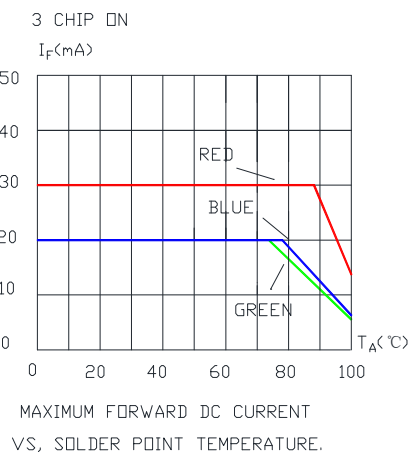
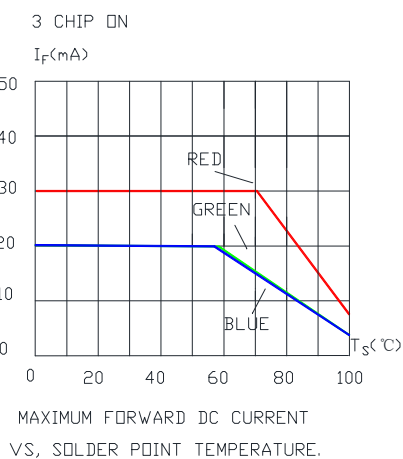
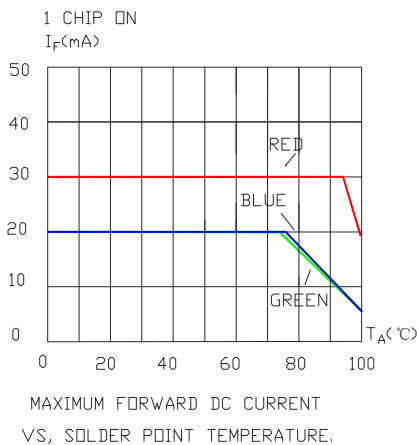
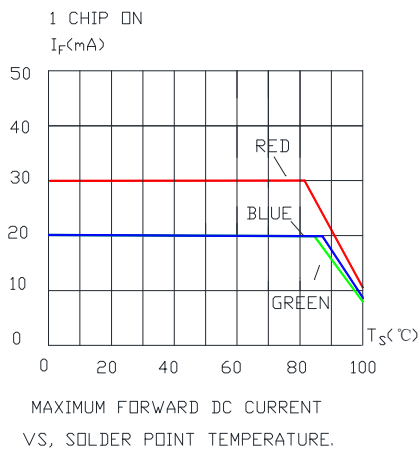
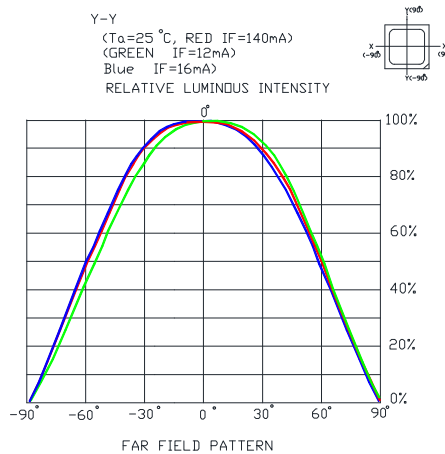
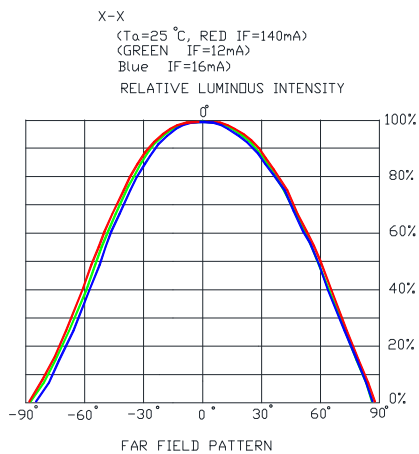

The above data are collected from statistical figures that do not necessarily correspond to the actual parameters of each single LED. Hence, these data will be changed without further notice.

## CAUTIONS

---

### 1. Cleaning

- When necessary, cleaning should occur only with isopropyl alcohol (IPA) at room temperature (25°C) for a duration of no more than one minute. Dry at room temperature for 15 minutes before use.
- The influence of ultrasonic cleaning on the SMD LED depends on factors such as ultrasonic power and the way the SMD LEDs are mounted. Ultrasonic cleaning should be pre-qualified to ensure this will not cause damage to the SMD LEDs.

### 2. Moisture-Proof Packing

- To prevent moisture absorption into SMD LEDs during the transportation and storage, the LEDs are packed in a moisture-barrier bag. Desiccants and a humidity indicator are packed together with the LEDs as secondary protection.
- A humidity-indicator card inside the packing indicates the humidity level.

### 3. Storage

- The shelf life of LEDs stored in the original sealed bag at <40°C and <90%RH is 12 months. Baking is required if the shelf life has expired.
- Before opening the packaging, check for air leaks in the bag.
- After the bag is opened, the SMD LEDs must be stored at < 30°C and < 60% RH. Under these conditions, SMD LEDs must be used (subject to reflow) within 168 hours. If the LEDs are not within 168 hours after removal from the bag, baking is required.
- To bake, place the SMD LEDs in an oven at 80°C ±5°C and relative humidity ≤10% RH for 24 hours.
- Take the material out of the packaging bag before baking. Do not open the oven door frequently during the baking process.

### 4. Soldering

#### a. Manual Soldering with a Soldering Iron

- Use of a soldering iron of less than 25 watts is recommended. The iron temperature must be kept below 315°C and soldering time no more than 2 seconds.
- The epoxy resin of an SMD LED should not contact the tip of the soldering iron.
- No mechanical stress should be exerted on the resin portion of an SMD LED during soldering.
- Handling of an SMD LED should be done only when the package has been cooled down to below 40°C or less. This is to prevent SMD LED failures due to thermal-mechanical stress during handling.



## b. Reflow Soldering

Temperature (top surface of the SMD LED) profile:

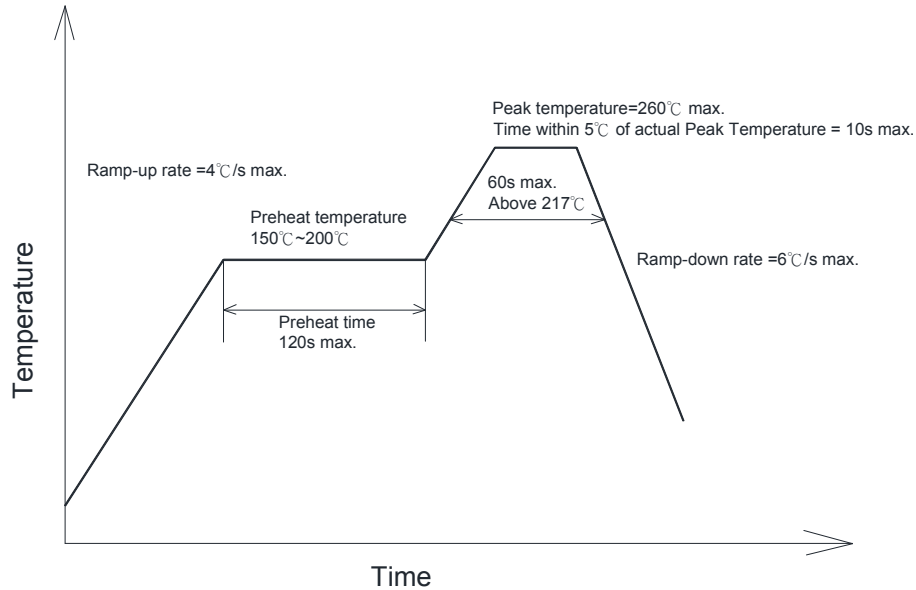

### Notes:

- SMD LEDs should not be modified after soldering. If modification cannot be avoided, the modifications must be pre-qualified to avoid damaging the SMD LEDs.
- In case of 2 times reflow process, 2nd reflow process must be performed as soon as possible after the 1st reflow.
- No stress should be exerted on the package during soldering.
- The PCB should not be wrapped after soldering; allow the PCB board and SMD LED to cool naturally.

## MECHANICAL DIMENSIONS

All dimensions are in mm.

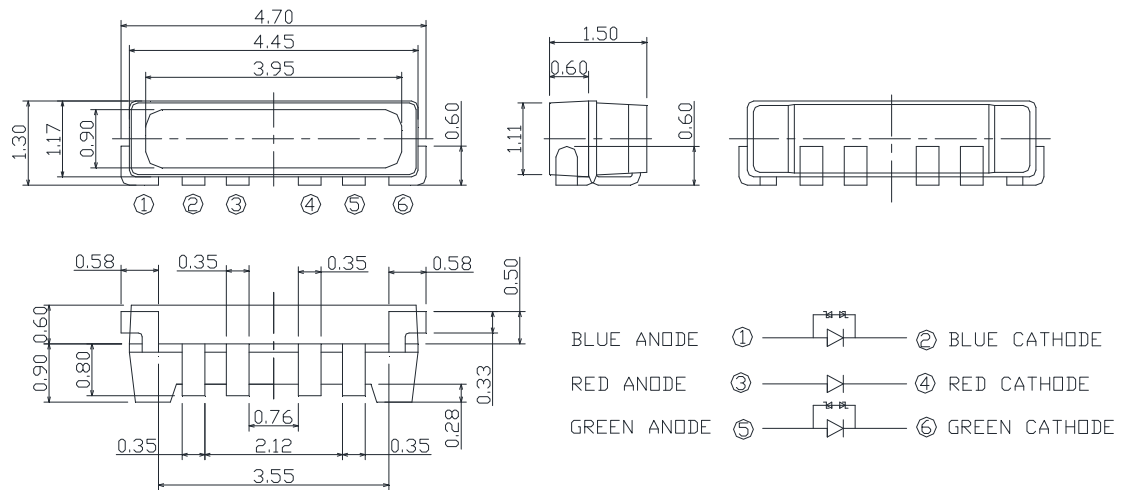

## NOTES

### RoHS Compliance

The levels of environmentally sensitive, persistent biologically toxic (PBT), persistent organic pollutants (POP), or otherwise restricted materials in this product are below the maximum concentration values (also referred to as the threshold limits) permitted for such substances, or are used in an exempted application, in accordance with EU Directive 2002/95/EC on the restriction of the use of certain hazardous substances in electrical and electronic equipment (RoHS), as amended through April 21, 2006.

### Vision Advisory Claim

Users should be cautioned not to stare at the light of this LED product. The bright light can damage the eye.

## KIT NUMBER SYSTEM

Cree LED lamps are tested and sorted into performance bins. A bin is specified by ranges of color, forward voltage, and brightness. Sorted LEDs are packaged for shipping in various convenient options. Please refer to the "Cree LED Lamp Packaging Standard" document for more information about shipping and packaging options.

Cree LEDs are sold by order codes in combinations of bins called kits. Order codes are configured in the following manner:

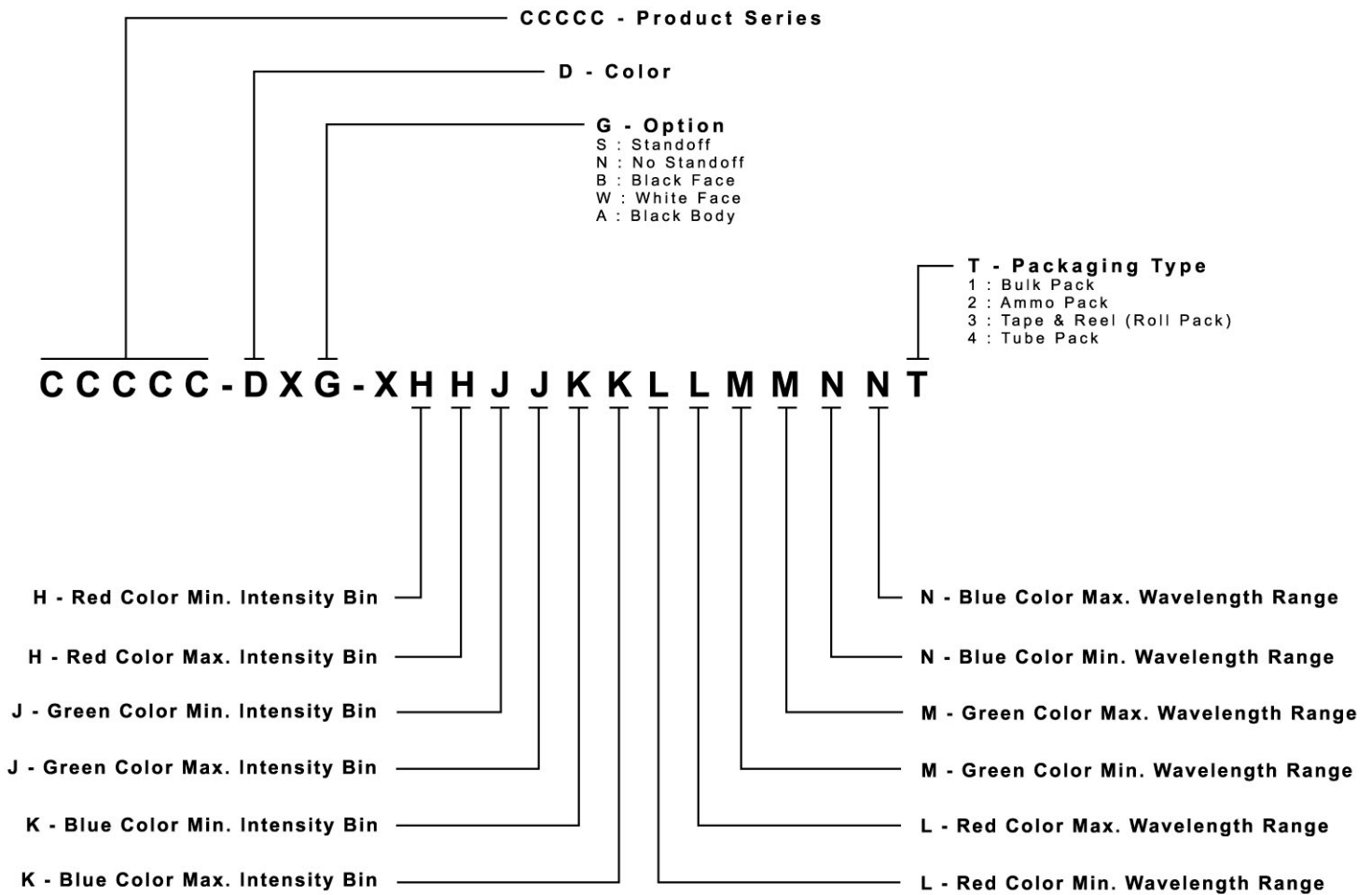

## PACKAGING

- The boxes are not water resistant and they must be kept away from water and moisture.
- The LEDs are packed in cardboard boxes after packaging in normal or anti-electrostatic bags.
- Cardboard boxes will be used to protect the LEDs from mechanical shocks during transportation.
- The reel pack is applied in SMD LED.
- Max 3000 pcs per reel.

