

Converter - Inverter Module

NPT IGBT

| Single Phase Rectifier | Three Phase Inverter |
|-----------------------------|-------------------------------|
| $V_{RRM} = 1600 \text{ V}$ | $V_{CES} = 600 \text{ V}$ |
| $I_{DAVM25} = 65 \text{ A}$ | $I_{C25} = 23 \text{ A}$ |
| $I_{FSM} = 550 \text{ A}$ | $V_{CE(sat)} = 2.1 \text{ V}$ |

Part name (Marking on product)

MIAA15WD600TMH

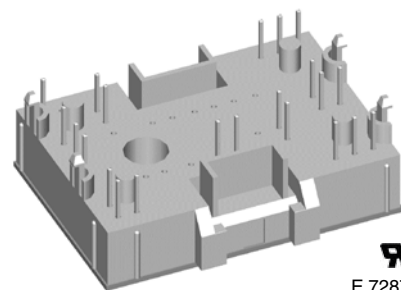
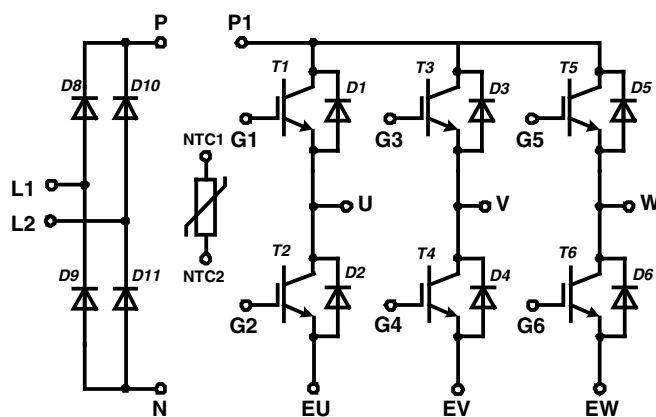

E 72873

Pin configuration see outlines.

Features:

- High level of integration - only one power semiconductor module required for the whole drive
- Inverter with NPT IGBTs
 - low saturation voltage
 - positive temperature coefficient
 - fast switching
 - short tail current
- Epitaxial free wheeling diodes with hiperfast soft reverse recovery
- Temperature sense included

Application:

- AC motor drives
- Pumps, Fans
- Washing machines
- Air-conditioning system
- Inverter and power supplies

Package:

- "Mini" package
- Assembly height is 17 mm
- Insulated base plate
- Pins suitable for wave soldering and PCB mounting
- Assembly clips available
 - IXKU 5-505 screw clamp
 - IXRB 5-506 click clamp
- UL registered E72873

Output Inverter T1 - T6

| Symbol | Definitions | Conditions | Ratings | | | Unit | |
|--|---------------------------------------|---|---|--|----------|--------|----------|
| | | | min. | typ. | max. | | |
| V_{CES} | collector emitter voltage | | $T_{VJ} = 150^{\circ}\text{C}$ | | 600 | V | |
| V_{GES} | max. DC gate voltage | continuous | | | ± 20 | V | |
| V_{GEM} | max. transient collector gate voltage | transient | | | ± 30 | V | |
| I_{C25} | collector current | | $T_C = 25^{\circ}\text{C}$ | | 23 | A | |
| I_{C80} | | | $T_C = 80^{\circ}\text{C}$ | | 16 | A | |
| P_{tot} | total power dissipation | | $T_C = 25^{\circ}\text{C}$ | | 80 | W | |
| $V_{CE(sat)}$ | collector emitter saturation voltage | $I_C = 15\text{ A}; V_{GE} = 15\text{ V}$ | $T_{VJ} = 25^{\circ}\text{C}$ $T_{VJ} = 125^{\circ}\text{C}$ | 2.1 2.3 | 2.5 | V V | |
| $V_{GE(th)}$ | gate emitter threshold voltage | $I_C = 0.4\text{ A}; V_{GE} = V_{CE}$ | $T_{VJ} = 25^{\circ}\text{C}$ | 4.5 | 5.5 | 6.5 | V |
| I_{CES} | collector emitter leakage current | $V_{CE} = V_{CES}; V_{GE} = 0\text{ V}$ | $T_{VJ} = 25^{\circ}\text{C}$ $T_{VJ} = 125^{\circ}\text{C}$ | | 1.0 | 0.6 | mA mA |
| I_{GES} | gate emitter leakage current | $V_{GE} = \pm 20\text{ V}$ | | | 150 | nA | |
| C_{ies} | input capacitance | $V_{CE} = 25\text{ V}; V_{GE} = 0\text{ V}; f = 1\text{ MHz}$ | | | 700 | pF | |
| $Q_{G(on)}$ | total gate charge | $V_{CE} = 300\text{ V}; V_{GE} = 15\text{ V}; I_C = 15\text{ A}$ | | | 57 | nC | |
| $t_{d(on)}$ | turn-on delay time | inductive load $V_{CE} = 300\text{ V}; I_C = 15\text{ A}$ $V_{GE} = \pm 15\text{ V}; R_G = 68\ \Omega$ | $T_{VJ} = 25^{\circ}\text{C}$ | | 40 | ns | |
| t_r | current rise time | | | | 45 | ns | |
| $t_{d(off)}$ | turn-off delay time | | | | 155 | ns | |
| t_f | current fall time | | | | 95 | ns | |
| E_{on} | turn-on energy per pulse | | | | 0.35 | mJ | |
| E_{off} | turn-off energy per pulse | | | | 0.27 | mJ | |
| $t_{d(on)}$ | turn-on delay time | inductive load $V_{CE} = 300\text{ V}; I_C = 15\text{ A}$ $V_{GE} = \pm 15\text{ V}; R_G = 68\ \Omega$ | $T_{VJ} = 125^{\circ}\text{C}$ | | 40 | ns | |
| t_r | current rise time | | | | 45 | ns | |
| $t_{d(off)}$ | turn-off delay time | | | | 160 | ns | |
| t_f | current fall time | | | | 120 | ns | |
| E_{on} | turn-on energy per pulse | | | | 0.55 | mJ | |
| E_{off} | turn-off energy per pulse | | | | 0.4 | mJ | |
| RBSOA | reverse bias safe operating area | $V_{GE} = \pm 15\text{ V}; R_G = 68\ \Omega; I_C = 30\text{ A}$ | $T_{VJ} = 125^{\circ}\text{C}$ | $V_{CEK} \leq V_{CES} - L_S \cdot di/dt$ | | V | |
| I_{SC} (SCSOA) | short circuit safe operating area | $V_{CE} = 360\text{ V}; V_{GE} = \pm 15\text{ V};$ $R_G = 68\ \Omega; t_p = 10\ \mu\text{s};$ non-repetitive | $T_{VJ} = 125^{\circ}\text{C}$ | 65 | | A | |
| R_{thJC} | thermal resistance junction to case | (per IGBT) | | | 1.6 | K/W | |
| R_{thCH} | thermal resistance case to heatsink | | | 0.55 | | K/W | |

Output Inverter D1 - D6

| Symbol | Definitions | Conditions | Ratings | | | Unit |
|------------|-------------------------------------|---|---|------------|------|---------------|
| | | | min. | typ. | max. | |
| V_{RRM} | max. repetitive reverse voltage | | $T_{VJ} = 150^{\circ}\text{C}$ | | 600 | V |
| I_{F25} | forward current | | $T_C = 25^{\circ}\text{C}$ | | 37 | A |
| I_{F80} | | | $T_C = 80^{\circ}\text{C}$ | | 24 | A |
| V_F | forward voltage | $I_F = 15\text{ A}; V_{GE} = 0\text{ V}$ | $T_{VJ} = 25^{\circ}\text{C}$ $T_{VJ} = 125^{\circ}\text{C}$ | 1.8 1.3 | 2.1 | V V |
| Q_{rr} | reverse recovery charge | $V_R = 300\text{ V}$ $di_F/dt = -380\text{ A}/\mu\text{s}$ $I_F = 15\text{ A}; V_{GE} = 0\text{ V}$ | $T_{VJ} = 125^{\circ}\text{C}$ | | 0.58 | μC |
| I_{RM} | max. reverse recovery current | | | | 11.5 | A |
| t_{rr} | reverse recovery time | | | | 115 | ns |
| E_{rec} | reverse recovery energy | | | | 50 | μJ |
| R_{thJC} | thermal resistance junction to case | (per diode) | | | 1.6 | K/W |
| R_{thCH} | thermal resistance case to heatsink | | | 0.55 | | K/W |

 $T_C = 25^{\circ}\text{C}$ unless otherwise stated

Input Rectifier Bridge D8 - D11

| Symbol | Definitions | Conditions | Ratings | | | Unit |
|------------|-------------------------------------|-------------------------|---|------------|-------------|--|
| | | | min. | typ. | max. | |
| V_{RRM} | max. repetitive reverse voltage | | $T_{VJ} = 25^{\circ}\text{C}$ | | 1600 | V |
| I_{FAV} | average forward current | sine 180° | $T_C = 80^{\circ}\text{C}$ | | 39 | A |
| I_{DAVM} | max. average DC output current | rect.; $d = 1/2$ | $T_C = 80^{\circ}\text{C}$ | | 42 | A |
| I_{FSM} | max. forward surge current | $t = 10$ ms; sine 50 Hz | $T_{VJ} = 25^{\circ}\text{C}$ $T_{VJ} = 125^{\circ}\text{C}$ | | 550 tbd | A A |
| I^2t | I^2t value for fusing | $t = 10$ ms; sine 50 Hz | $T_{VJ} = 25^{\circ}\text{C}$ $T_{VJ} = 125^{\circ}\text{C}$ | | 1270 tbd | A^2s A^2s |
| P_{tot} | total power dissipation | | $T_C = 25^{\circ}\text{C}$ | | 100 | W |
| V_F | forward voltage | $I_F = 30$ A | $T_{VJ} = 25^{\circ}\text{C}$ $T_{VJ} = 125^{\circ}\text{C}$ | 1.2 1.3 | 1.5 | V V |
| I_R | reverse current | $V_R = V_{RRM}$ | $T_{VJ} = 25^{\circ}\text{C}$ $T_{VJ} = 125^{\circ}\text{C}$ | 0.3 | 0.03 | mA mA |
| R_{thJC} | thermal resistance junction to case | (per diode) | | 0.4 | 1.2 | K/W |
| R_{thCH} | thermal resistance case to heatsink | (per diode) | | | | K/W |

Temperature Sensor NTC

| Symbol | Definitions | Conditions | Ratings | | | Unit | |
|-------------|-------------|------------|----------------------------|------|------|--------|------------------|
| | | | min. | typ. | max. | | |
| R_{25} | resistance | | $T_C = 25^{\circ}\text{C}$ | 4.75 | 5.0 | 5.25 | $\text{k}\Omega$ |
| $B_{25/50}$ | | | | | 3375 | | K |

Module

| Symbol | Definitions | Conditions | Ratings | | | Unit |
|------------|-----------------------------------|--------------------------------|---------|------|------|--------------------|
| | | | min. | typ. | max. | |
| T_{VJ} | operating temperature | | -40 | | 125 | $^{\circ}\text{C}$ |
| T_{VJM} | max. virtual junction temperature | | | | 150 | $^{\circ}\text{C}$ |
| T_{stg} | storage temperature | | -40 | | 125 | $^{\circ}\text{C}$ |
| V_{ISOL} | isolation voltage | $I_{ISOL} \leq 1$ mA; 50/60 Hz | | | 2500 | V~ |
| CTI | comparative tracking index | | | - | | |
| F_C | mounting force | | 40 | | 80 | N |
| d_S | creep distance on surface | | 12.7 | | | mm |
| d_A | strike distance through air | | 12 | | | mm |
| Weight | | | | 35 | | g |

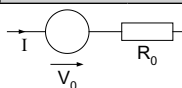
Equivalent Circuits for Simulation

| Symbol | Definitions | Conditions | Ratings | | | Unit |
|--------|---------------------|------------|--------------------------------|------|------|------------------|
| | | | min. | typ. | max. | |
| V_0 | rectifier diode | D8 - D11 | $T_{VJ} = 125^{\circ}\text{C}$ | 0.9 | | V |
| R_0 | | | | 6 | | $\text{m}\Omega$ |
| V_0 | IGBT | T1 - T6 | $T_{VJ} = 125^{\circ}\text{C}$ | 1.15 | | V |
| R_0 | | | | 77 | | $\text{m}\Omega$ |
| V_0 | free wheeling diode | D1 - D6 | $T_{VJ} = 125^{\circ}\text{C}$ | 1.05 | | V |
| R_0 | | | | 30 | | $\text{m}\Omega$ |

 $T_C = 25^{\circ}\text{C}$ unless otherwise stated

Circuit Diagram

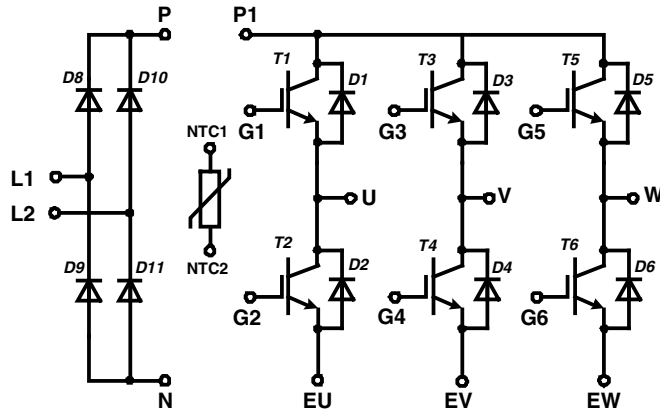

Outline Drawing

Dimensions in mm (1 mm = 0.0394")

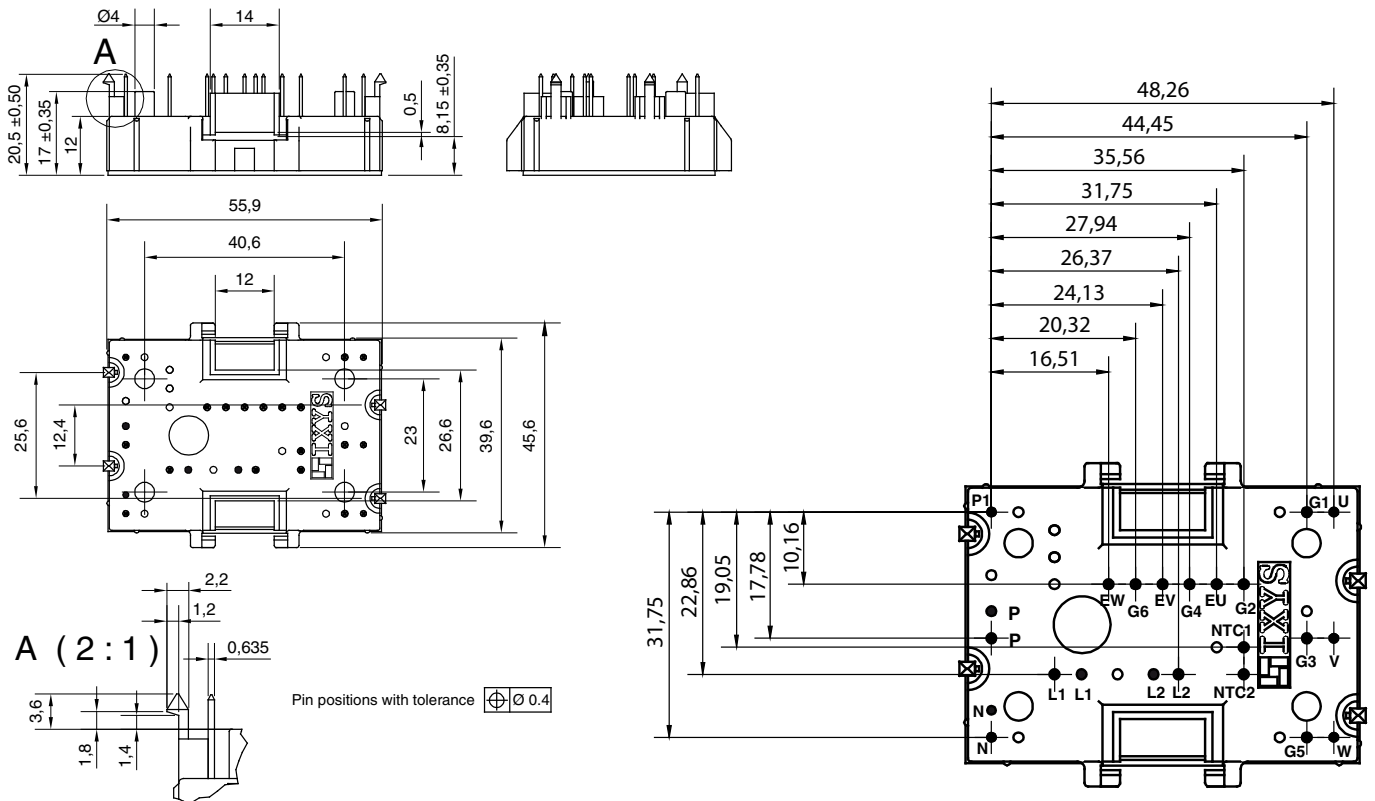

Product Marking

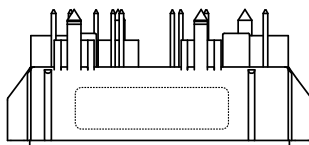

Part number

M = Module
 I = IGBT
 A = IGBT (NPT)
 A = Gen 1 / std
 15 = Current Rating [A]
 WD = 6-Pack + 1~ Rectifier Bridge
 600 = Reverse Voltage [V]
 T = NTC
 MH = MiniPack2

| Ordering | Part Name | Marking on Product | Delivering Mode | Base Qty | Ordering Code |
|----------|--------------------|--------------------|-----------------|----------|---------------|
| Standard | MIAA 15 WD 600 TMH | MIAA15WD600TMH | Box | 20 | 504869 |

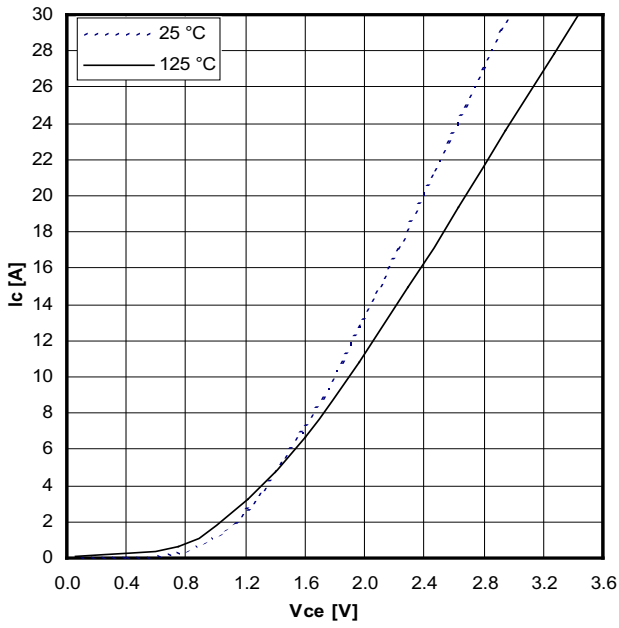

Typical output characteristics, $V_{GE} = 15\text{ V}$

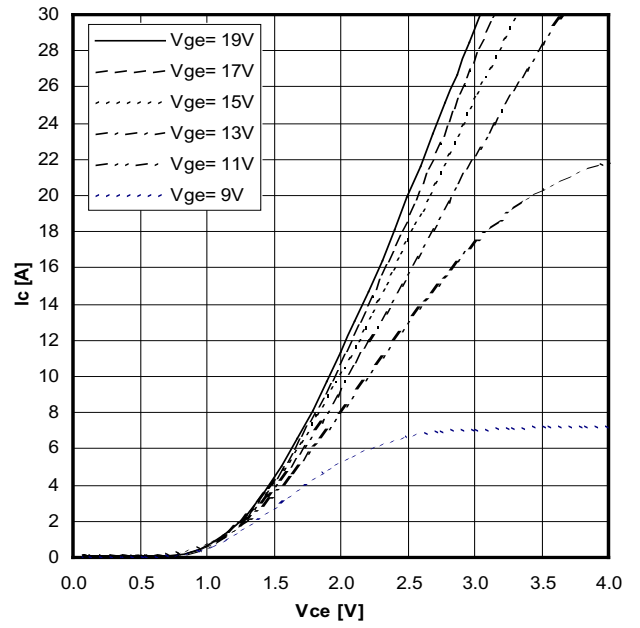

Typical output characteristics ($125\text{ }^\circ\text{C}$)

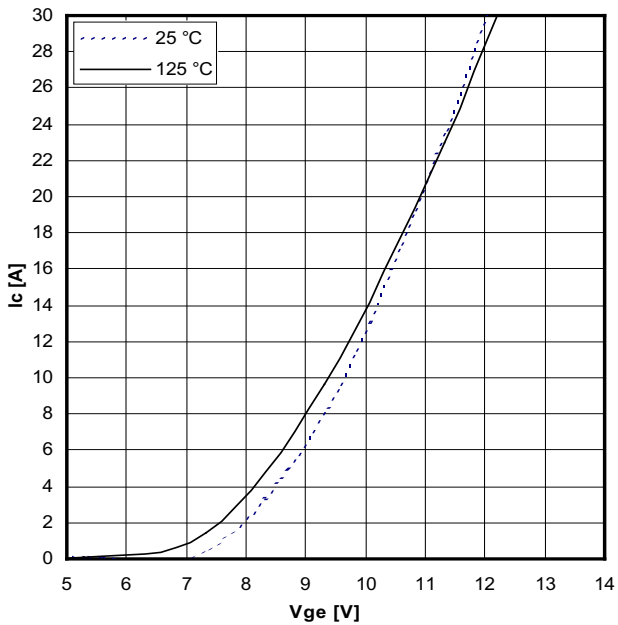

Typical transfer characteristics

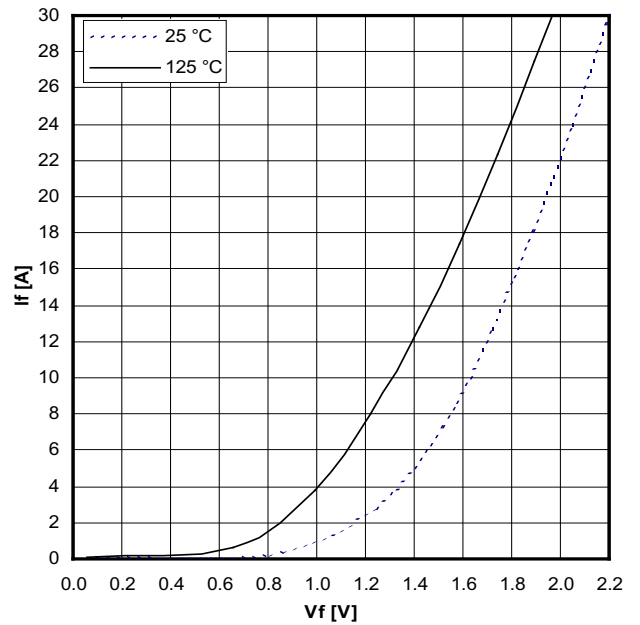

Typical forward characteristics of freewheeling diode

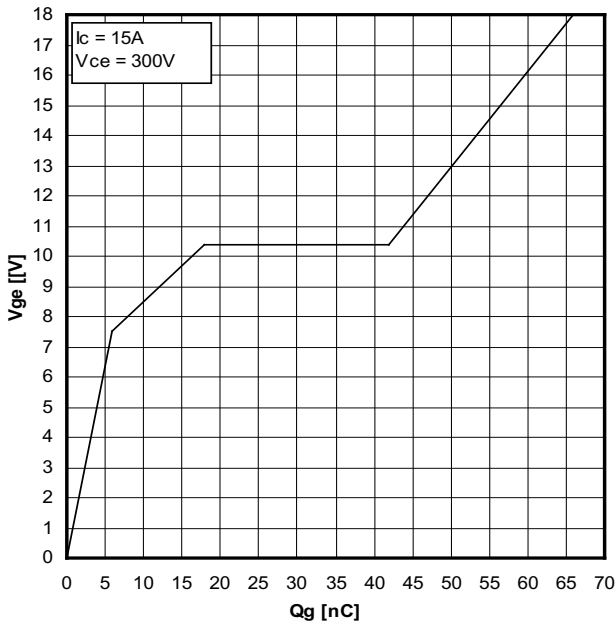

Typical turn on gate charge

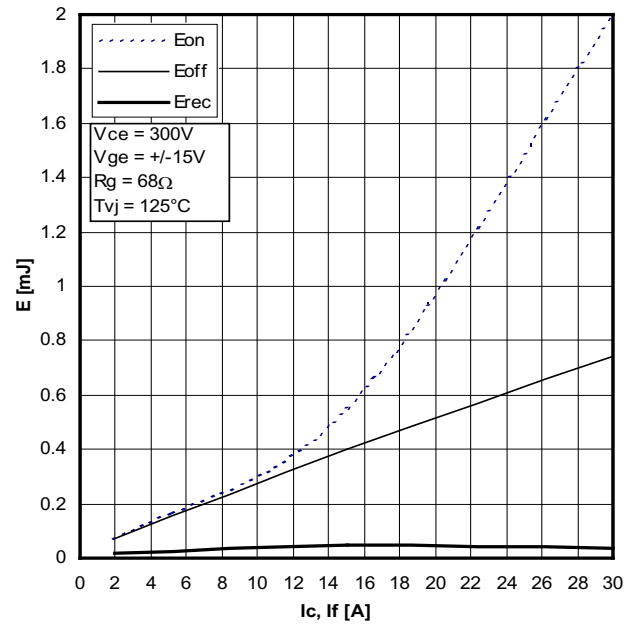

Typical switching energy versus collector current

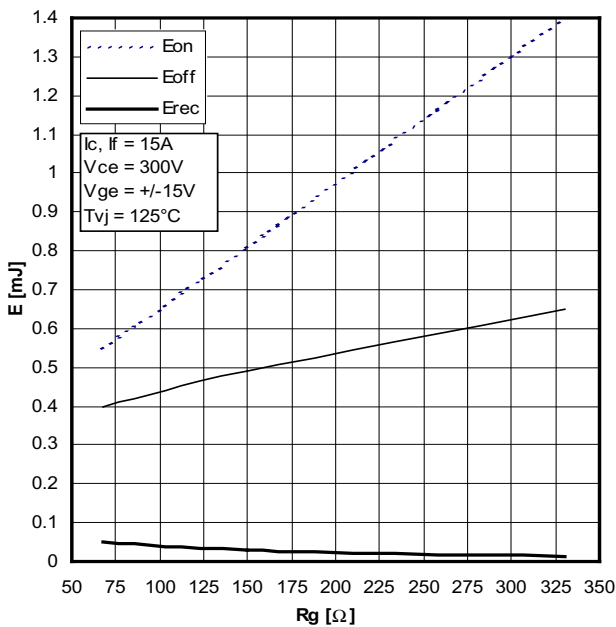

Typical switching energy versus gate resistance

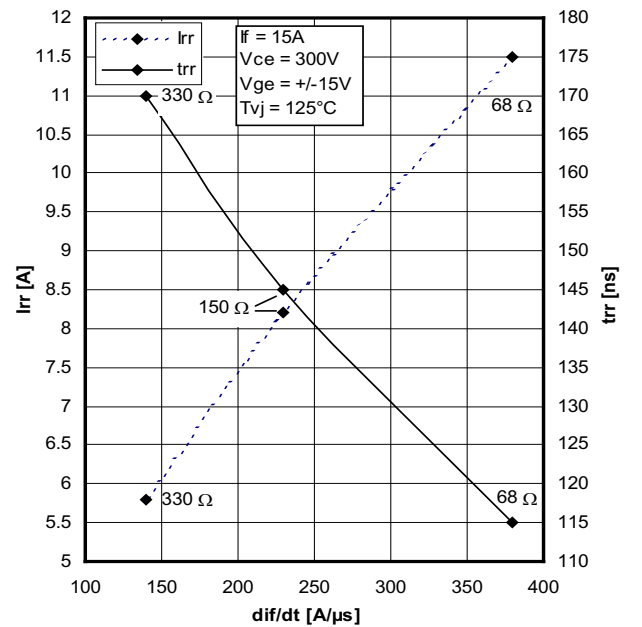

Typical turn-off characteristics of free wheeling diode

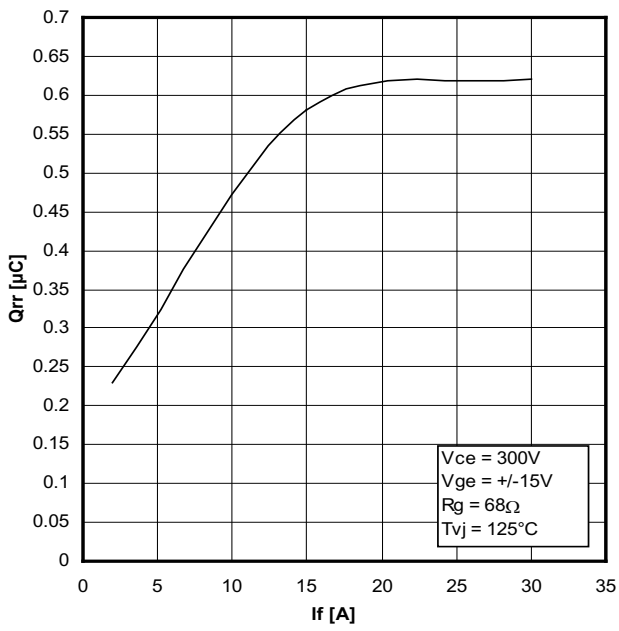

Typical turn-off characteristics of free wheeling diode

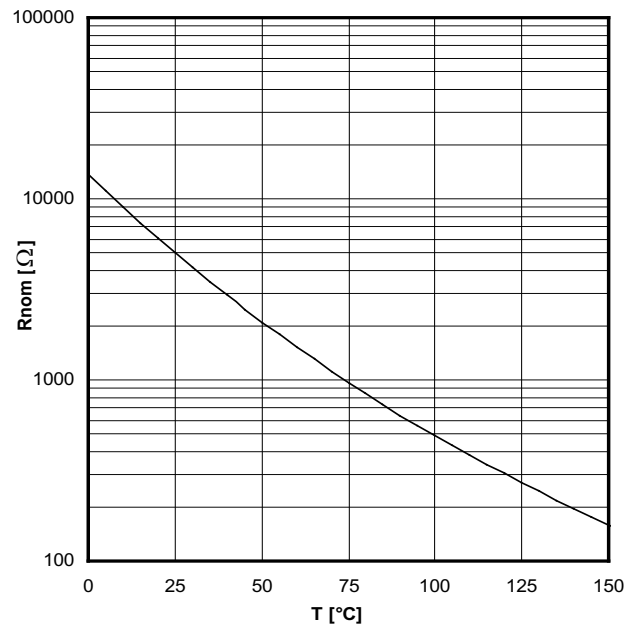

Typical thermistor resistance versus temperature