

Noise Dosimeter with PC Interface

Model 407355

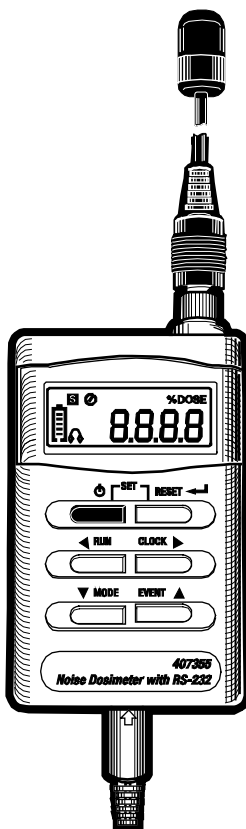

Introduction

Congratulations on your purchase of the Extech 407355 Personal Noise Dosimeter. The 407355 is designed to test noise exposure in accordance with OSHA, MSHA, DOD, ACGIH, and ISO standards. Fast and easy on-site surveys help determine noise reduction requirements. The meter can also be used in SLM (sound level meter) mode where sound pressure levels are monitored from 70 to 140dB. The SLM (sound level meter) mode has a datalogging feature that can record up to 8800 readings which can be downloaded to a PC for analysis. Please visit our website (www.extech.com) to check for the latest version of this User Guide, Product Updates, and Customer Support.

The built-in RS-232 PC interface offers the following capabilities:

- In SOUND LEVEL METER (SLM) MODE: The meter can be connected to PC while taking measurements so that readings can be stored in a file and readings can be viewed in a variety of display configurations (graph, list, etc.).
- In DOSIMETER mode: The meter can perform a noise survey after which the user can transfer the survey data to a PC.

Note: In DOSIMETER mode, the individual measurements are NOT logged and cannot be recalled.

Careful use of this device will provide years of reliable service.

CE Certification



The CE-mark indicates compliance to the EMC directive

Safety

EN 61010-1 (1993) and IEC 1010-1 (1990); Safety requirements for electrical equipment for measurement, control, and laboratory use

EMC Emission

EN 50081-1 (1992): Generic emission standard

Part 1: Residential, commercial, and light industry

EN 50081-2 (1993): Generic emission standard

Part 2: Industrial environment

CISPR22 (1993): Radio disturbance characteristics of information technology equipment. Class B limits.

FCC rules, part 15: Complies with the limits for a Class B digital device

EMC Immunity

EN 50082-1 (1992): Generic immunity standard

Part 1: Residential, commercial, and light industry

RF immunity implies that sound level indications of 70dB or greater will be affected by no more than ± 1.5 dB

EN 50082-2 (1995): Generic immunity standard

Part 2: Industrial environment

RF immunity implies that sound level indications of 70dB or greater will be affected by no more than ± 1.5 dB

Descriptions

Display Description

1. FAST Response Time mode
2. SLOW Response Time mode
3. Noise Exposure test active
4. Memory mode alert
5. Noise Exposure test paused
6. Unit of measure for Noise Exposure test
7. Battery Status Indicator
8. Event memory banks (E1-E5)
9. 115dB limit (headphone) indicator
10. Numerical display digits
11. Unit of measure for sound level readings
12. 140dB PEAK indicator
13. Elapsed time mode for noise exposure tests

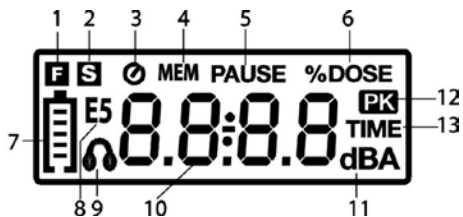



Meter Description

1. Microphone (lapel clip not shown)
2. Microphone cable
3. Microphone connector
4. LCD display
5. Push-buttons:

ON-OFF  Press to turn the meter ON; Press and hold to turn the meter OFF.

RESET  This button has a variety of uses including clearing stored data and accessing the Programming mode as described in the manual.

RUN  Press to begin a noise survey test in Dosimeter mode or datalogging in SLM mode. Also used as the Left Arrow in the Programming mode

CLOCK  Press to view the Date and Time. Also used as the Right Arrow in Programming mode

MODE  Press to select ELAPSED TIMER, dBA (SLM) mode, or noise survey (%DOSE) mode. Also used as the Down Arrow in the Programming mode

EVENT  Press to select a memory bank (E1 through E5). Also used as the Up Arrow in the Programming mode

6. RS-232 PC Interface plug
7. RS-232 PC Interface jack
8. Calibration potentiometer
9. Battery compartment screw
10. Belt clip / Battery compartment cover
11. Battery compartment
12. Microphone jack
13. Housing screws (service personnel only)

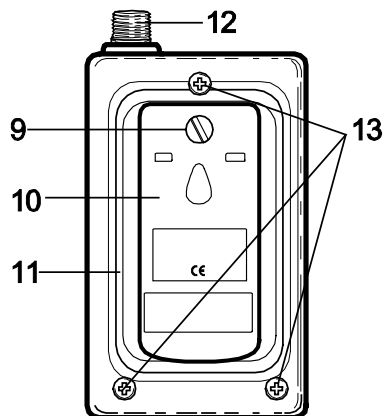
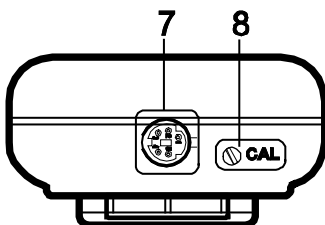

Operation

Getting Started

1. Power the instrument by pressing the green  button.
2. When the unit is turned on, all display items switch on briefly followed by 'dOSE', the Criterion Level (**Lc**), Threshold Level (**Lt**), and Exchange Rate (**ER**) respectively. These parameters are defined in the Noise Exposure related sections of this manual.
3. If the meter does not switch on when the power button is pressed, check that the batteries are installed and are fresh. Refer to the Battery Replacement section of this manual.
4. To turn the meter OFF, press and hold the green power button; the display will count down from 3dB to 0dB and then switch off.
5. The 407355 can be used as a Sound Level Meter or a Dosimeter.
- 6.

Sound Level Meter Operation (dBA mode)

Press the MODE button repeatedly until the unit of measure is dBA (A-weighted decibels). In SLM mode the meter operates as a Type 2 sound level meter. The 407355 measures and displays sound pressure levels from 70 to 140dB. Read the measured sound level on the LCD. For Sound Level measurements < 68dBA the LCD will display dashed lines. For readings > 115dBA, the headphone  icon appears. For readings > 140dBA, the Peak Detector **PK** icon appears.

Datalogging

- In Sound Level Meter (dBA) mode, the internal memory of the meter can store up to 8800 readings.
1. Press the RUN key to start recording the measured readings. The **MEM** icon will appear in the display.
 2. To stop datalogging, press the RUN key again. The **MEM** icon will no longer be displayed on the screen.
 3. To download the data to a PC, refer to the PC Interface section in this manual.

Dosimeter Operation (%DOSE mode)

1. Program the Response Time (Fast or Slow), Criterion Level (Lc), Exchange Rate (ER), and Threshold Level (Lt) manually (see Programming section) or program these parameters through the supplied software (see PC Interface section).
NOTE: Make sure you have enough memory to complete your noise survey.
See ERASE MEMORY section before proceeding
2. Use the MODE button to select %DOSE as the unit of measure.
3. Select an unused Event Bank (E1 through E5) using the EVENT button. (Event is NOT flashing)
4. Attach the meter to the user's belt buckle, breast pocket, or where convenient
5. Clip the microphone as close as possible to the user's ear (shirt collar, for example) using the lapel clip.
6. Route the cable as to not hinder the working movements of the user.
7. Press the RUN button to begin measuring accumulated noise exposure.
The Clock display icon will appear on the display.
8. Press the RUN button momentarily to PAUSE the test (PAUSE display icon will switch on).
Press the RUN button again to resume the test (PAUSE icon will switch off).

9. Use the MODE button at any time to view the elapsed time of the test. Press the MODE button until the TIME display icon appears. Now the elapsed time will appear in hours and minutes. Press the RUN button again to return to the %DOSE display.

10. To end the noise survey and SAVE your recording

Press and hold the RUN key for >3 seconds. The Clock icon will disappear and the Event bank will start flashing.

Read the accumulated noise exposure value on the LCD.

NOTE: If you Event bank number is not flashing – do NOT turn off the meter or your recorded data will be erased.

11. Testing notes:

- Never shout into the microphone as this will affect the test.
- Use caution during recording to prevent the microphone from coming into contact with any objects.
- To obtain reliable data, the user's activities must reflect a typical working day.
- For best results, test over the course of several days and average the %DOSE

Programming the %DOSE settings

NOTE: The meter can be automatically programmed using the supplied software.

To *Manually* Program the meter, follow these steps:

1. To access the programming mode, start with the 407355 power off.
2. Press and hold the ◀ (RESET) button while turning the instrument on.
3. Release the RESET button when **SEP (Setting Parameters)** appears.
4. Use the left ◀ and right ▶ arrow buttons to select the desired parameter
5. Use the up ▲ and down ▼ arrow buttons to change a parameter's setting
6. Refer to the parameter display symbols and their definitions below.
These parameters are discussed throughout this manual

LC	(Criterion Level): 80, 84, 85, 90dB selections
LT	(Threshold Level): 70 to 90dB selectable in 1dB steps
ER	(Exchange Rate): 3, 4, 5, and 6 dB selections
20	First two digits of calendar year
14	Last two digits of calendar year
1-	Calendar Month
-08	Day of the Month
14:	Hour of the day (24 Hr)
:30	Minutes
S F	Slow (1 second) and Fast (125ms) response time settings

7. Press the ◀ **RESET** button to exit the programming mode.
Changes made in the programming mode will be saved upon exiting.
Note: The settings are saved when the meter is turned off.

Calibration Procedure

Note that an acoustical calibrator (such as the Extech 407744 or 407766) is required to calibrate the 407355. Extech Instruments can also calibrate the instrument and provide an N.I.S.T. certificate if desired.

1. Set the instrument to the Sound Level Measurement Mode (dBA) using the MODE button.
2. Set the response time to SLOW (see the Programming section)
3. Insert the 407355 microphone into the microphone cavity of the calibrator.
4. Turn the calibrator ON for 94.0 dB and adjust the CAL screw on the 407355 so that the LCD display matches the calibrator output signal.

Note: OSHA regulations consider it good business practice to calibrate before and after each use.

A yearly calibration is recommended to maintain measurement accuracy.

Erase the Memory

If the low battery mark is flashing or **all of the** Dosimeter survey **memory** E1 through E5 has been filled, the datalogging function will not operate.

The memory must be cleared.

Clear memory in a single Event bank:

If data is present in a single bank, the bank ID flashes.

To erase data in a specific bank, press and hold the RESET button until the bank ID stops flashing.

Clear all of the memory in the whole meter:

To clear the memory in the whole meter for SLM data only, turn the meter off then hold down the **RUN** key and turn on the meter.

E-EP will appear in the display to indicate that all memory data has been cleared, release the RUN key.

To clear Dose data, erase each individual bank.

Dosimetry Parameter Descriptions

% DOSE

The unit of measure, % DOSE, is used to quantify noise exposure measured during a work shift. 100% dose is the maximum allowable noise exposure in accordance with OSHA, MSHA, DOD, ACGIH, and ISO standards. Most standards specify Criterion Level, Exchange Rate, Response Time, and Frequency weighting for the dosimeter as discussed next.

EVENT SELECT

Press the EVENT button to enter the EVENT mode. Each time the EVENT button is pressed the LCD increments the Event bank number (E1 through E5). Each bank is a memory location. The user can store (or write over) the data in any of these locations. Each bank location (E1, for example) is displayed on the LCD along with the stored data.

If data is present in a bank, the bank ID flashes.

To erase data in a bank, press and hold the RESET button until the display ID stops flashing.

CRITERION LEVEL (Lc)

To take an on-site noise exposure survey in accordance with standards such as OSHA and MSHA, the dosimeter's Criterion Level must first be set. The 100% DOSE parameter discussed above is determined by the following equation: $100\% \text{ DOSE} = \text{Criterion Level for 8 hours}$. Each country has a unique Criterion Level (most countries, including the U.S., use 90dB). The Criterion level is selectable (80, 84, 85, or 90dB). Select the appropriate level per the Programming section of this manual.

EXCHANGE RATE (ER)

Exchange rate is best illustrated by example; refer to the following example: Since $100\% \text{ DOSE} = \text{Criterion Level for 8 hours}$, a person would receive 50% DOSE in 4 hours if the noise level equals the Criterion Level setting. Now consider a Criterion Level of 90dB, a noise measurement of 95dB (5dBA higher than the Criterion Level), and an Exchange Rate of 5dB; in this example a 100% DOSE would be received in only 4 hours. This is because with a 5dB Exchange Rate, a 5dB increase in sound level is considered a doubling of the DOSE. Other Exchange Rates can be selected (3, 4, 5, or 6dB). Refer to the local regulations or standards.

FAST (F) SLOW (S) RESPONSE TIME

Set the response time to Fast (F) to capture quick bursts of sound such as discharging firearms, fireworks, hammering, and other impulse noises. Use the Slow (S) setting if the noise under test is more of a continuous drone or background din. The Slow setting is typically specified by OSHA and MSHA standards for use in noise surveys. Refer to the Programming section of this manual to set the response time.

THRESHOLD LEVEL (Lt)

The threshold level is the sound level at which the 407355 begins to integrate noise into the exposure test. For example, if the threshold level (Lt) is set to 85dB, the meter will integrate all noise that equals or exceeds 85 dB. Sound levels below this threshold would not be included in the dose calculation. See the Programming section to change the level. The Threshold Level can be set from 70 to 90dB in 1 dB steps.

PEAK FLAG

When sound levels above 140dB are present the meter displays the **PK** symbol.

HIGH LEVEL INDICATOR

When sound levels above 115dB are present the meter displays the headphone  symbol.

REAL TIME CLOCK

Press the CLOCK key to display the current Day and Time accompanied by the TIME icon blinking. Note that the DATE and TIME settings are saved when the meter is turned off. To set the TIME and DATE refer to the Programming section.

PC Interface

This meter has the capability to connect to and communicate with a PC. To install and use the software, please refer to the instructions provided on the supplied CD-ROM and/or the instructions provided in the HELP Utility within the software program.

Check the software download page of the website www.extech.com for the latest version of the PC software and its operating system compatibility.

Battery Replacement and Status Display

The 407355 is powered by four (4) 'AAA' 1.5V batteries and the LCD display employs a 5-segment battery status indicator.

5-segment battery LCD status indicator



When the batteries are fully charged, all five segments of the indicator will be visible. As the batteries discharge, the segments switch off one by one. Do not use the instrument if all five segments have switched off.

To replace the batteries:

1. Remove the large flat-head screw from the back of the instrument. This will free the belt clip; remove the clip.
2. The discharged 1.5V 'AAA' batteries will be visible behind the clip.
3. Replace the batteries observing polarity.
4. Re-assemble the clip.



Never dispose of used batteries or rechargeable batteries in household waste. As consumers, users are legally required to take used batteries to appropriate collection sites, the retail store where the batteries were purchased, or wherever batteries are sold.

Disposal: Do not dispose of this instrument in household waste. The user is obligated to take end-of-life devices to a designated collection point for the disposal of electrical and electronic equipment.

Specifications

Display	Multi-function LCD
Units of measure	dBA ('A' weighted decibels) for sound level % DOSE for accumulated noise exposure
Measurement ranges	70 to 140dBA for sound level (SPL) measurements 0.01 to 9999 %DOSE for noise exposure surveys
Standards applied	±1dB high accuracy meets Class 2 standards (IEC 61672-2013 and ANSI/ASA S1.4/Part 1)
Criterion level	80, 84, 85, and 90dB (selectable)
Threshold level	70 to 90dB in 1dB steps (selectable)
Exchange rate	3, 4, 5, and 6dB (selectable)
High level detector	 appears on LCD when measurement exceeds 115dBA
Peak flag	PK appears on LCD when measurement exceeds 140dBA
Accuracy	±1.0dB
Frequency weighting	'A' weighting
Frequency response	31.5Hz to 8 kHz
Response time	F (FAST) and S (SLOW) selectable
Datalogging capacity	8800 data sets
Operating Temperature	0 to 50°C (32 to 122°F)
Operating Humidity	10 to 90% RH
Storage Temperature	-10 to 60°C (14 to 140°F)
Storage Humidity	10 to 75% RH
Battery power	Four (4) 1.5V 'AAA' batteries
Battery life	40 hours (approx.)
Dimensions	106 (L) x 60 (W) x 34 (H) mm 4.2 (L) x 2.4 (W) x 1.3 (H)"
Weight	Approx. 350g (12.3 oz) with batteries

Conversion Charts

OSHA Permissible Noise Exposures

Duration per day, hours	Sound level dBA, slow response
8	90
6	92
4	95
3	97
2	100
1.5	102
1	105
0.5	110
0.25 or less	115
<i>Source:29 CFR 1910 Table G-16</i>	

Conversion from Percent Noise Exposure or Dose to 8-Hour Time Weighted Average Sound Level(TWA)

Dose or percent	TWA (dBA)
50	85.0
55	85.7
60	86.3
65	86.9
70	87.4
75	87.9
80	88.4
85	88.8
90	89.2
95	89.6
100	90.0
105	90.4
110	90.7
115	91.1
120	91.3
125	91.6
Note: Assumes 5-dB exchange rate and 90-dBA Criterion	

Copyright © 2013-2017 FLIR Systems, Inc.

All rights reserved including the right of reproduction in whole or in part in any form
ISO-9001 Certified

www.extech.com