



PCS/UMTS HIGH IP3 RFIC DOWNCONVERTER, 1.7 - 2.2 GHz

Typical Applications

The HMC380QS16G / HMC380QS16GE is ideal for:

- GSM, GPRS & EDGE Infrastructure
- CDMA, WCDMA Infrastructure
- PHS Infrastructure

Features

- +19 dBm Input IP3
- Low LO Drive: -5 dBm
- Conversion Gain: 11 dB
- Noise Figure: 9 dB
- Single Positive Supply: +5V, 165 mA

Functional Diagram

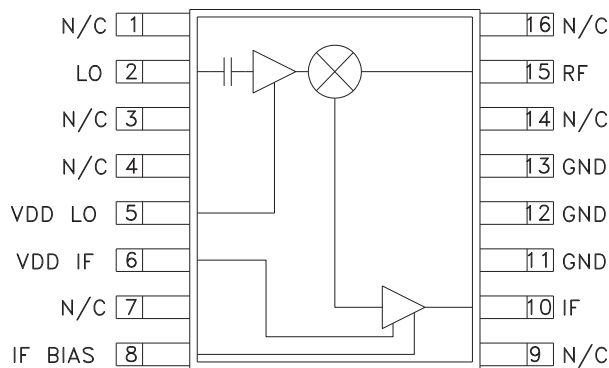

General Description

The HMC380QS16G & HMC380QS16GE are high linearity down-converter receiver ICs suitable for PCS/UMTS infrastructure applications from 1.7 - 2.2 GHz. The receiver IC is designed to support UMTS applications where a high third order intercept point is required. A passive mixer coupled with a high dynamic range IF amplifier achieves an input IP3 of +19 dBm. The converter provides a gain of 11.5 dB and 9 dB typical single side band noise figure. The IC operates from a positive +5V rail consuming 165 mA of current while only requiring a -5 dBm LO drive. The design requires no external baluns. The mixer supports IF frequencies between 50 MHz and 300 MHz.

Electrical Specifications, $T_A = +25^\circ C$, LO = -5 dBm, Vdd = 5V, IF = 250 MHz ^[1]

Parameter	Min.	Typ.	Max.	Min.	Typ.	Max.	Units
Frequency Range, RF	1.7 - 2.0		2.0 - 2.2				GHz
Frequency Range, LO	1.4 - 1.95		1.7 - 2.15				GHz
Frequency Range, IF ^[2]	50 - 300		50 - 300				MHz
Conversion Gain	9	11.5		9	11.5		dB
Noise Figure (SSB)		9.2	10.5		10	11.5	dB
LO to RF Isolation	20	25		23	28		dB
LO to IF Isolation	22	32		30	38		dB
RF to IF Isolation	38	50		46	54		dB
IP3 (Input)	17	19		17	19		dBm
1 dB Compression (Input)	3	5		3	6		dBm
LO Input Drive Level (Typical)	-5 to 0		-5 to 0				dBm
Supply Current (I _{dd} for LO & IF) (IF bias resistor= 3.3 Ohms)		175			175		mA

[1] Unless otherwise noted all measurements with low side LO & IF = 250 MHz.

[2] If matching must be tuned for optimal results, see application circuit herein.



**PCS/UMTS HIGH IP3 RFIC
DOWNCONVERTER, 1.7 - 2.2 GHz**

Conversion Gain vs. Temperature

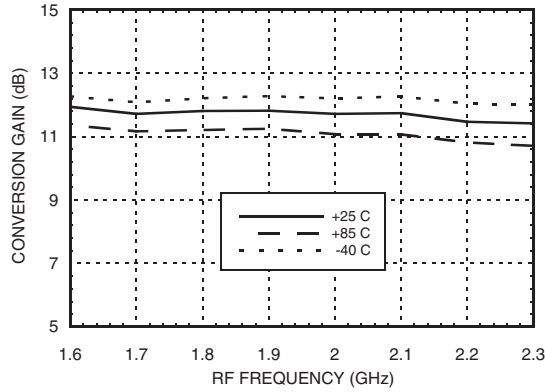

Isolation

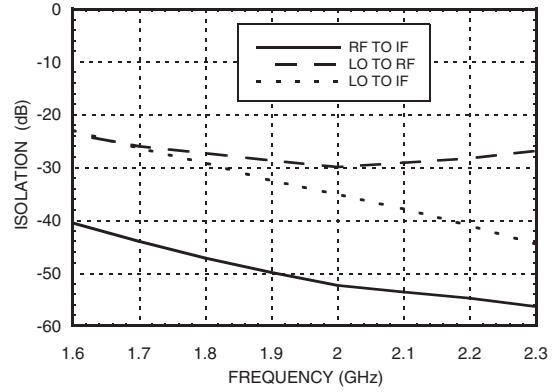

Conversion Gain vs. LO Drive

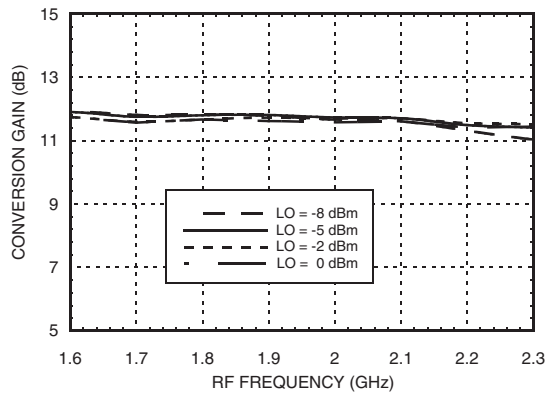

Return Loss

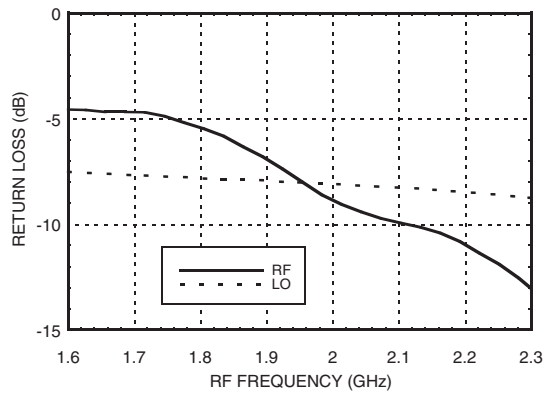

Input P1dB vs. Temperature

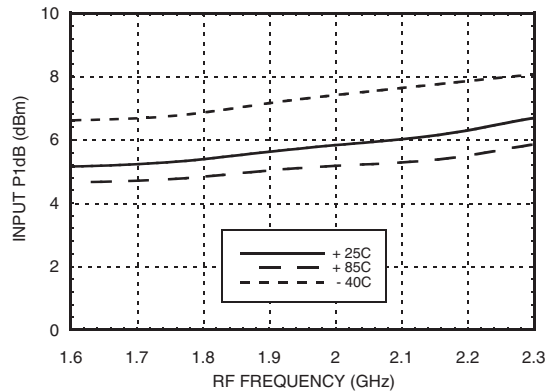

IF Bandwidth

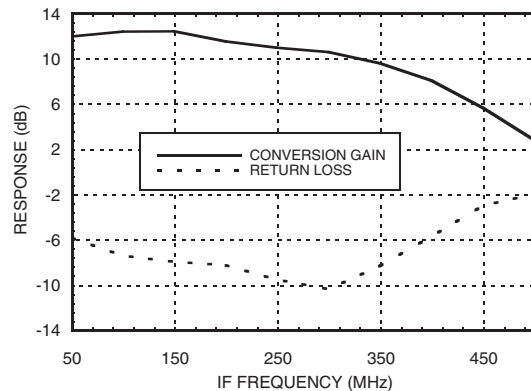

* Unless otherwise noted all measurements with low side LO & IF = 250 MHz.

** If matching must be tuned for optimal results, see application circuit herein.

Information furnished by Analog Devices is believed to be accurate and reliable. However, no responsibility is assumed by Analog Devices for its use, nor for any infringements of patents or other rights of third parties that may result from its use. Specifications subject to change without notice. No license is granted by implication or otherwise under any patent or patent rights of Analog Devices. Trademarks and registered trademarks are the property of their respective owners.

For price, delivery, and to place orders: Analog Devices, Inc., One Technology Way, P.O. Box 9106, Norwood, MA 02062-9106 Phone: 781-329-4700 • Order online at www.analog.com Application Support: Phone: 1-800-ANALOG-D



**PCS/UMTS HIGH IP3 RFIC
DOWNCONVERTER, 1.7 - 2.2 GHz**



MIXERS - DOWNCONVERTERS - SMT

Input and Output IP3 vs. Temperature

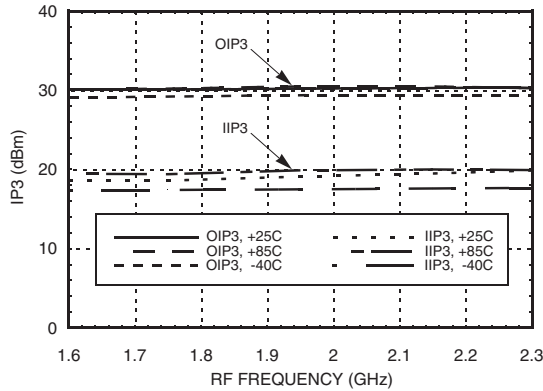

Input and Output IP3 vs LO Drive

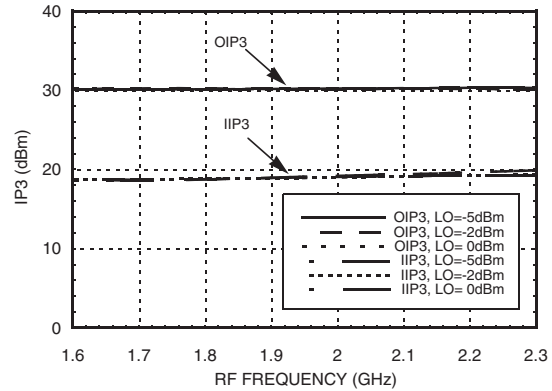

**Noise Figure vs Temperature
Swept LO, Fixed IF = 250 MHz**

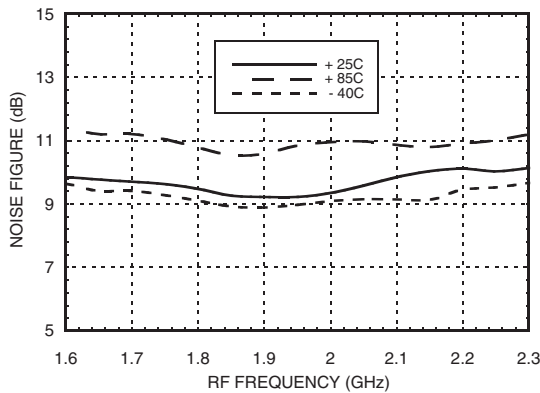

**Noise Figure
Swept IF, Fixed LO = 1.7 GHz**

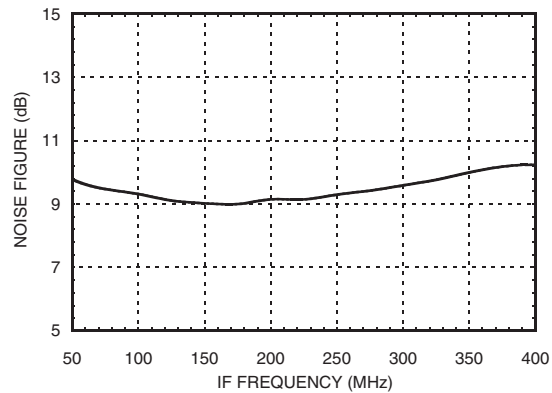

**Conversion Gain
with IF Tuned for 70 MHz**

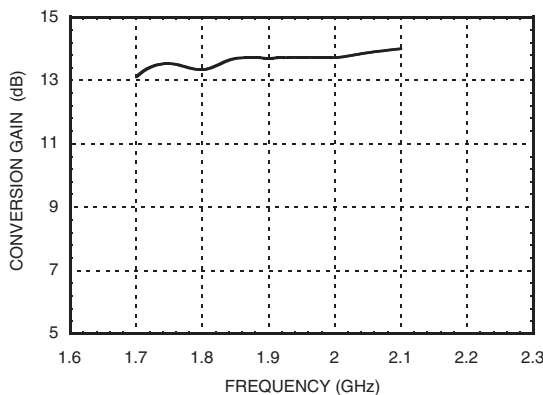

IP3 with IF Tuned for 70 MHz

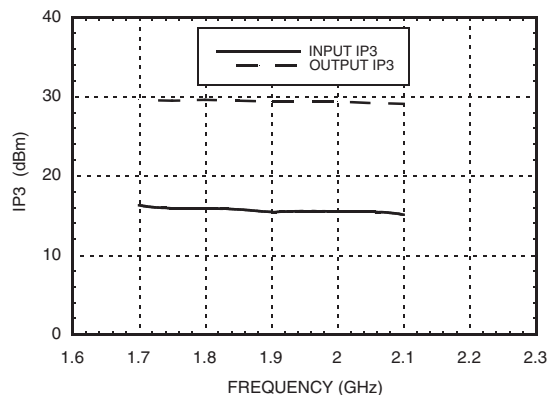

* Unless otherwise noted all measurements with low side LO & IF = 250 MHz.

** If matching must be tuned for optimal results, see application circuit herein.

Information furnished by Analog Devices is believed to be accurate and reliable. However, no responsibility is assumed by Analog Devices for its use, nor for any infringements of patents or other rights of third parties that may result from its use. Specifications subject to change without notice. No license is granted by implication or otherwise under any patent or patent rights of Analog Devices. Trademarks and registered trademarks are the property of their respective owners.

For price, delivery, and to place orders: Analog Devices, Inc., One Technology Way, P.O. Box 9106, Norwood, MA 02062-9106
Phone: 781-329-4700 • Order online at www.analog.com
Application Support: Phone: 1-800-ANALOG-D

**PCS/UMTS HIGH IP3 RFIC
DOWNCONVERTER, 1.7 - 2.2 GHz**
MxN Spurious @ IF Port

mRF	nLO				
	0	1	2	3	4
0	xx	40	60	58	35
1	62	0	62	87	102
2	124	101	55	94	110
3	126	126	113	76	112
4	121	127	128	124	116

RF Freq. = 1.9 GHz @ -10 dBm
LO Freq. = 1.65 GHz @ -5 dBm
All values in dBc relative to the IF power level.

Harmonics of LO

LO Freq. (GHz)	nLO Spur @ RF Port			
	1	2	3	4
1.4	23	3	16	15
1.6	26	6	12	18
1.8	26	8	10	29
2.0	24	8	12	31
2.2	38	10	14	35
2.4	23	12	19	40

LO = -5 dBm
All values in dBc below input LO level measured at RF port.



PCS/UMTS HIGH IP3 RFIC DOWNCONVERTER, 1.7 - 2.2 GHz

Absolute Maximum Ratings

RF / IF Input (Vdd= +5V)	+13 dBm
LO Drive (Vdd= +5V)	+15 dBm
Vdd (LO or IF)	+7 Vdc
Channel Temperature	150°C
Continuous Pdiss (T = 85°C) (derate 17 mW/°C above 85°C)	1.10 W
Thermal Resistance (channel to ground paddle)	59 °C/W
Storage Temperature	-65 to +150°C
Operating Temperature	-40 to +85°C

Typical Supply Current vs. Vdd

Vdd (LO + IF)	Idd (mA)
+4.5	162
+5.0	165
+5.5	168

Downconverter will operate over full voltage range shown above.



**ELECTROSTATIC SENSITIVE DEVICE
OBSERVE HANDLING PRECAUTIONS**

Outline Drawing

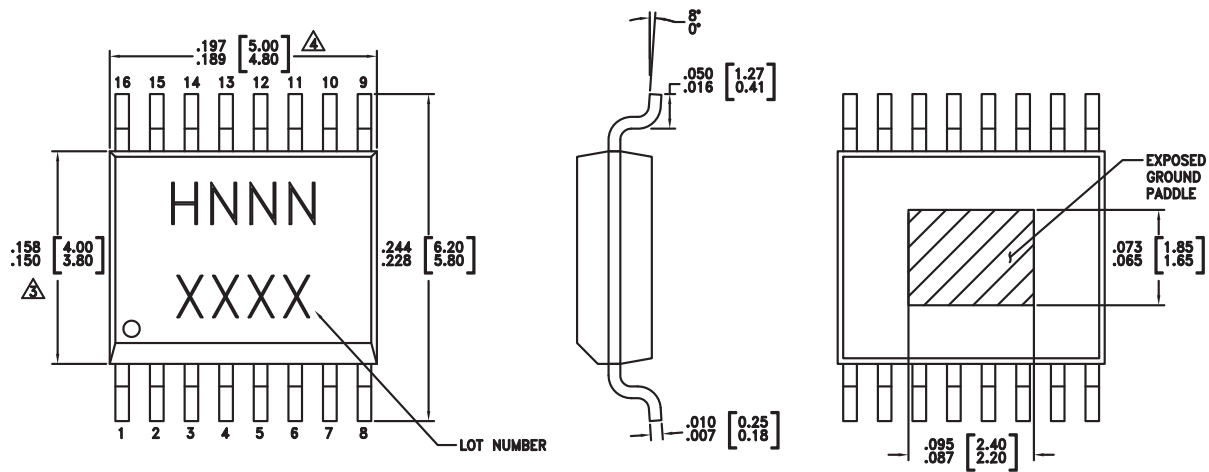

NOTES:

- LEADFRAME MATERIAL: COPPER ALLOY
- DIMENSIONS ARE IN INCHES [MILLIMETERS].
- DIMENSION DOES NOT INCLUDE MOLDFLASH OF 0.15mm PER SIDE.
- DIMENSION DOES NOT INCLUDE MOLDFLASH OF 0.25mm PER SIDE.
- ALL GROUND LEADS MUST BE SOLDERED TO PCB RF GROUND.
- CLASSIFIED AS MOISTURE SENSITIVITY LEVEL (MSL) 1.

Package Information



Part Number	Package Body Material	Lead Finish	MSL Rating	Package Marking ^[3]
HMC380QS16G	Low Stress Injection Molded Plastic	Sn/Pb Solder	MSL1 ^[1]	H380 XXXX
HMC380QS16GE	RoHS-compliant Low Stress Injection Molded Plastic	100% matte Sn	MSL1 ^[2]	H380 XXXX

[1] Max peak reflow temperature of 235 °C

[2] Max peak reflow temperature of 260 °C

[3] 4-Digit lot number XXXX

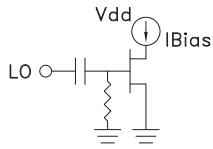
**PCS/UMTS HIGH IP3 RFIC
DOWNCONVERTER, 1.7 - 2.2 GHz**
Pin Descriptions

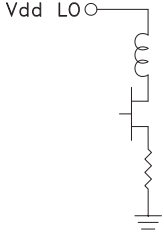
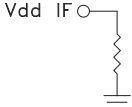
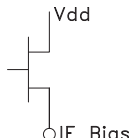
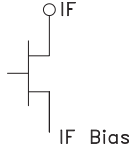
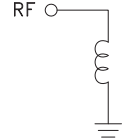
Pin Number	Function	Description	Interface Schematic
1, 3, 4, 7, 9, 14, 16	N/C	Not Connected	
2	LO	This pin is AC coupled and matched to 50 Ohm from 1.4 - 2.2 GHz.	
11, 12, 13	GND	Backside of package has exposed metal ground slug that must also be connected to RF/DC ground.	
5	Vdd LO	Power supply for the LO amplifier. One external RF bypass capacitor (10,000 pF) is required.	
6	Vdd IF	Bias voltage for IF amplifier. One external RF bypass capacitor (10,000 pF) is required.	
8	IF Bias	DC bias setting for IF amplifier.	
10	IF	Output of IF and bias port for amplifier. A pull up inductor (L1), output matching network (C5, C6, L2), and 10,000 pF bypass capacitor (C4) are required.	
15	RF	This pin is DC coupled and matched to 50 Ohm from 1.7 - 2.2 GHz.	



Evaluation PCB

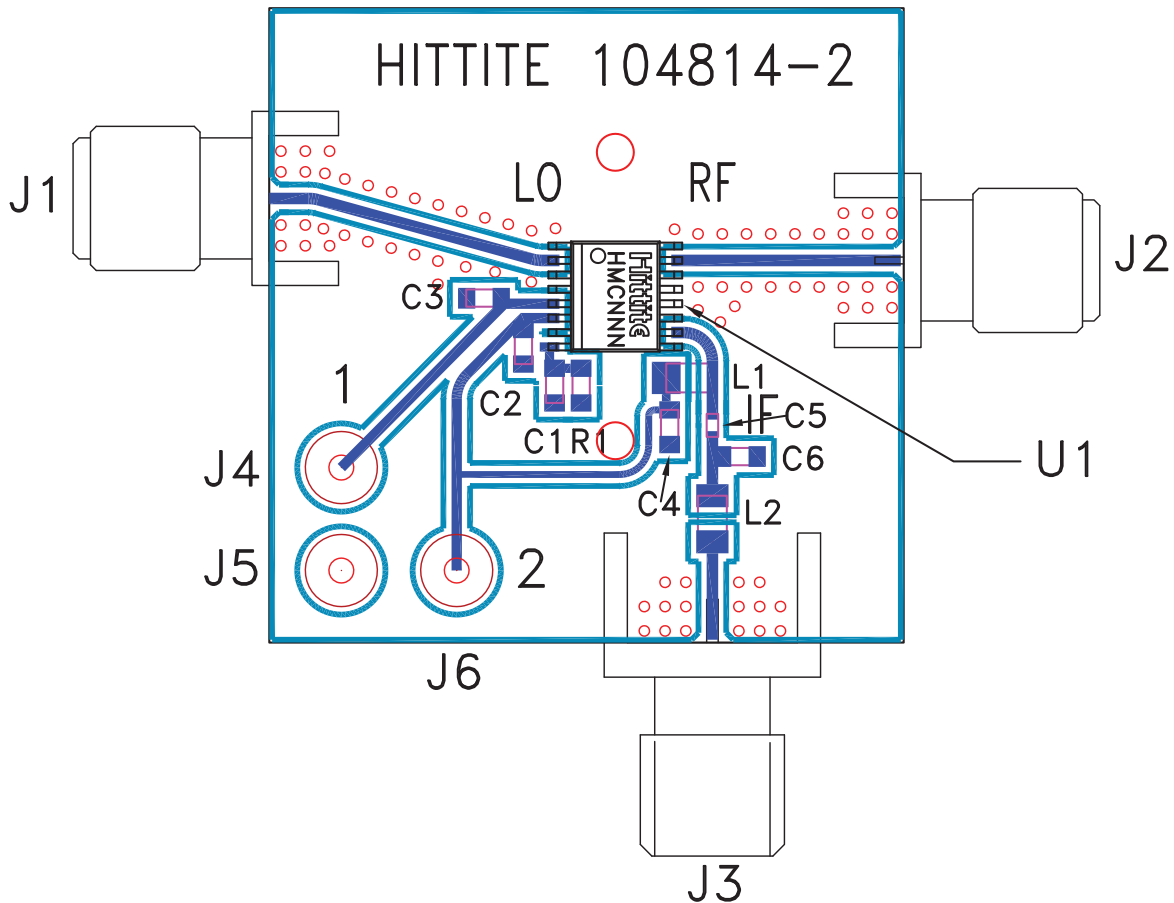

List of Materials for Evaluation PCB 106397 [1]

Item	Description
J1 - J3	PC Mount SMA RF Connector
J4 - J6	DC Pins
C1	1000 pF Chip Capacitor, 0603 Pkg.
C2, C3, C4	0.01µF Chip Capacitor, 0603 Pkg.
C5	82 pF Chip Capacitor, 0402 Pkg.
C6	6 pF Chip Capacitor, 0603 Pkg.
L1	150 nH Chip Inductor, 0805 Pkg.
L2	27 nH Chip Inductor, 0805 Pkg.
R1	3.3 Ohm Resistor, 0603 Pkg.
U1	HMC380QS16G / HMC380QS16GE
PCB [2]	104814 Evaluation Board, 1.100" x 1.100"

[1] Reference this number when ordering complete evaluation PCB

[2] Circuit Board Material: Rogers 4350

The circuit board used in the final application should use RF circuit design techniques. Signal lines should have 50 ohm impedance while the package ground leads and exposed paddle should be connected directly to the ground plane similar to that shown. A sufficient number of via holes should be used to connect the top and bottom ground planes. The evaluation circuit board shown is available from Hittite upon request.



Application Circuit

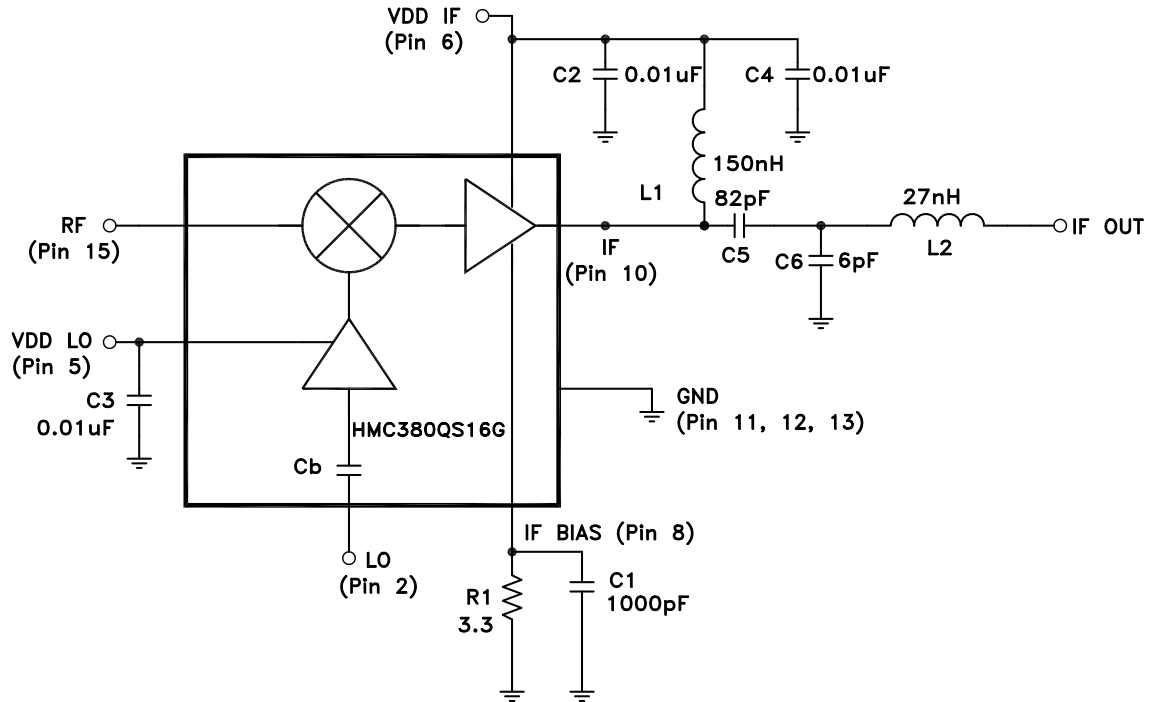

Note: Pin 5 and Pin 6 may be connected to a common Vdd Supply.

**Selection of L2 & C6
For Various Tuned IF Frequencies***

IF	L2	C6
250 MHz	27 nH	6 pF
70 MHz	39 nH	39 pF

* Contact Hittite to optimize tuning topology for desired IF frequency.

* Unless otherwise noted all measurements with low side LO & IF = 250 MHz.

** If matching must be tuned for optimal results, see application circuit herein.

Information furnished by Analog Devices is believed to be accurate and reliable. However, no responsibility is assumed by Analog Devices for its use, nor for any infringements of patents or other rights of third parties that may result from its use. Specifications subject to change without notice. No license is granted by implication or otherwise under any patent or patent rights of Analog Devices. Trademarks and registered trademarks are the property of their respective owners.

For price, delivery, and to place orders: Analog Devices, Inc., One Technology Way, P.O. Box 9106, Norwood, MA 02062-9106 Phone: 781-329-4700 • Order online at www.analog.com Application Support: Phone: 1-800-ANALOG-D