

## FLORENCE-1R-Z60

~60° + 110° medium beam

### TECHNICAL SPECIFICATIONS:

Dimensions	19.5 x 286.0 mm
Height	7.6 mm
Fastening	clips
Colour	clear
Box size	398 x 298 x 265 mm
Box weight	7.1 kg
Quantity in Box	165 pcs
ROHS compliant	yes ⓘ



### MATERIAL SPECIFICATIONS:

Component	Type	Material	Colour
FLORENCE-1R-Z60	Lens	PMMA	clear

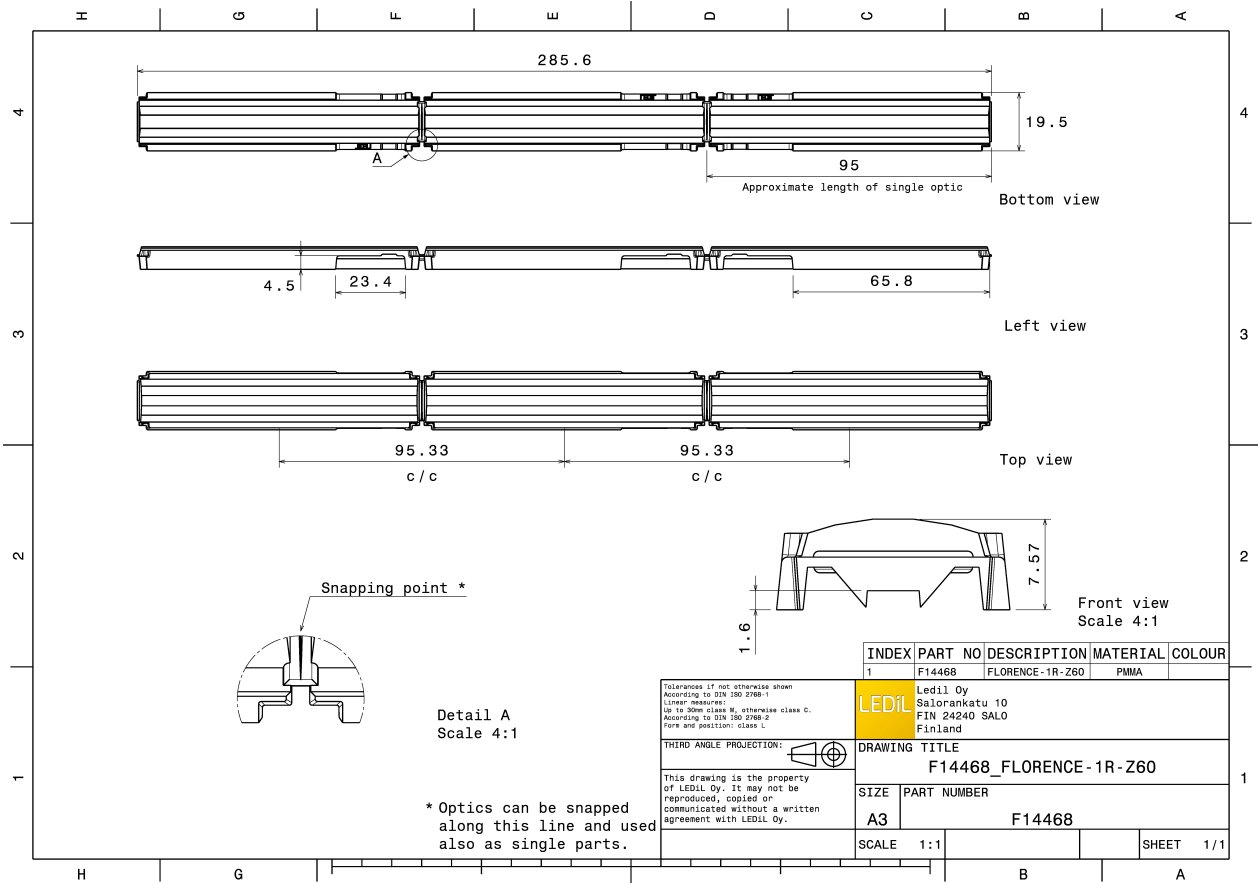

### PHOTOMETRIC DATA (MEASURED):



LED CALGD0414-M8W1  
FWHM 58.0 + 121.0°  
Efficiency 94 %  
Peak intensity 0.550 cd/lm  
Required components:

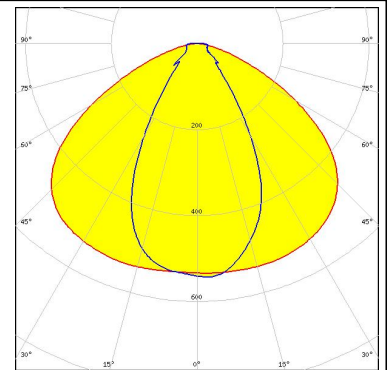

LED CALGD0814-M17W1  
FWHM 57.0 + 118.0°  
Efficiency 92 %  
Peak intensity 0.550 cd/lm  
Required components:

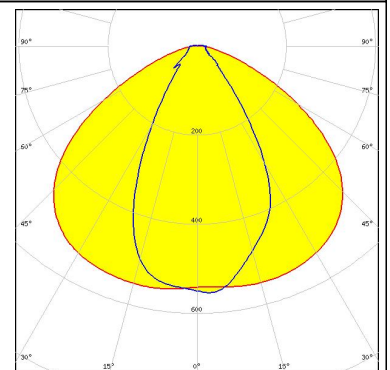

LED L0-280024-xxx-C0800-L267  
FWHM 65.0 + 107.0°  
Efficiency 93 %  
Peak intensity 0.530 cd/lm  
Required components:

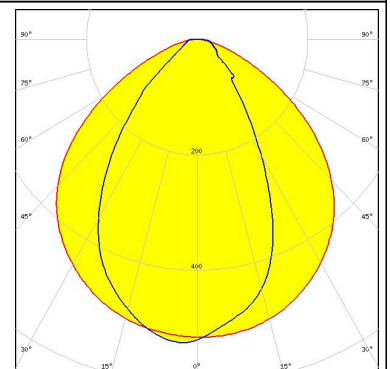
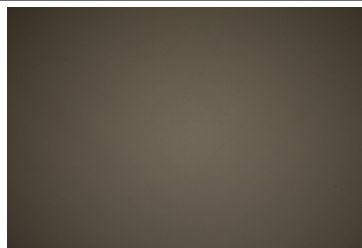

LED XH-B/G  
FWHM 63.0 + 113.0°  
Efficiency 94 %  
Peak intensity 0.540 cd/lm  
Required components:

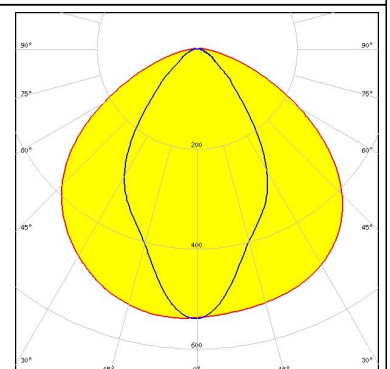
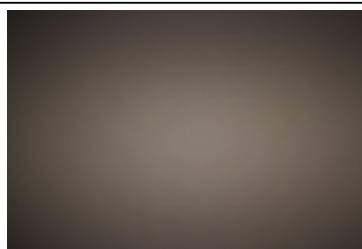

#### PHOTOMETRIC DATA (MEASURED):

##### LUMILEDS

LED LUXEON 3014  
 FWHM 59.0 + 115.0°  
 Efficiency 94 %  
 Peak intensity 0.640 cd/lm  
 Required components:

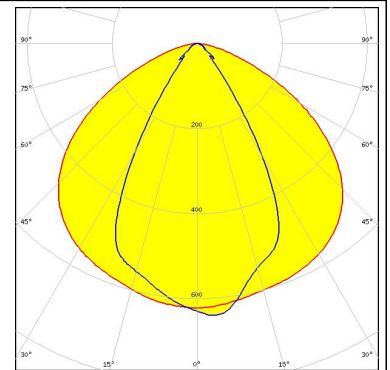

##### LUMILEDS

LED LUXEON 3020  
 FWHM 55.0 + 117.0°  
 Efficiency 94 %  
 Peak intensity 0.660 cd/lm  
 Required components:

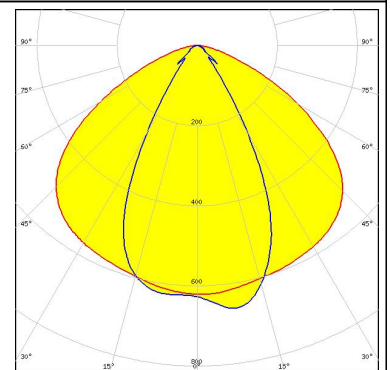
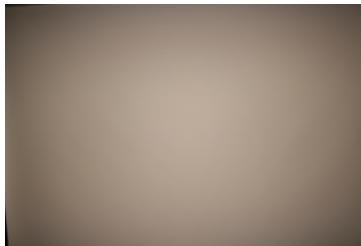

##### LUMILEDS

LED LUXEON 3030 2D (Round LES)  
 FWHM 57.0 + 114.0°  
 Efficiency 94 %  
 Peak intensity 0.600 cd/lm  
 Required components:

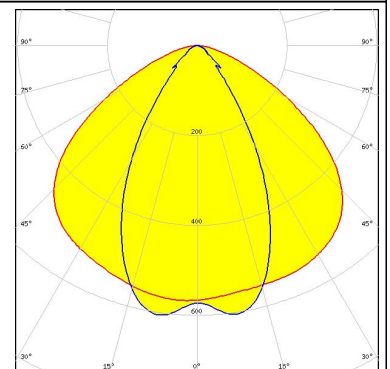

##### LUMILEDS

LED LUXEON 3535 2D  
 FWHM 60.0 + 109.0°  
 Efficiency 94 %  
 Peak intensity 0.590 cd/lm  
 Required components:

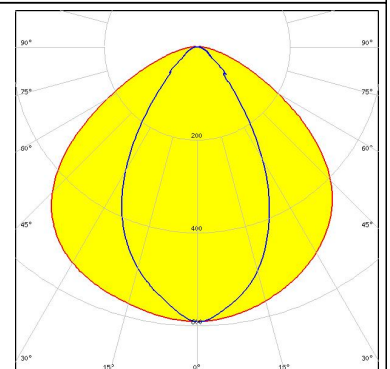
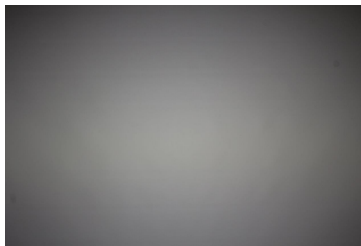

#### PHOTOMETRIC DATA (MEASURED):



LED LUXEON 3535L  
 FWHM 59.0 + 110.0°  
 Efficiency 94 %  
 Peak intensity 0.620 cd/lm  
 Required components:

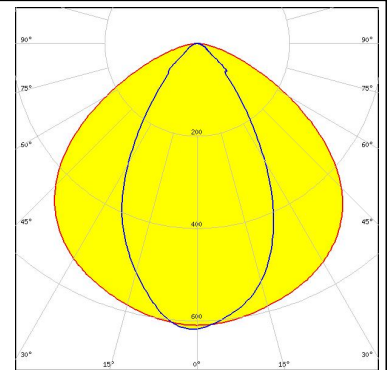

LED MP-2016  
 FWHM 58.0 + 115.0°  
 Efficiency 94 %  
 Peak intensity 0.630 cd/lm  
 Required components:

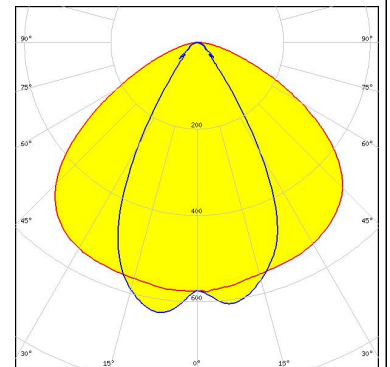
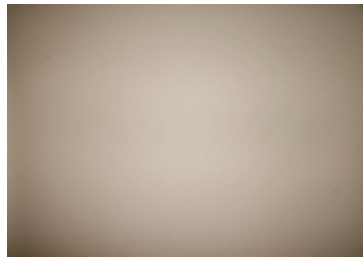

LED NF2x757D  
 FWHM 59.0 + 114.0°  
 Efficiency 94 %  
 Peak intensity 0.570 cd/lm  
 Required components:

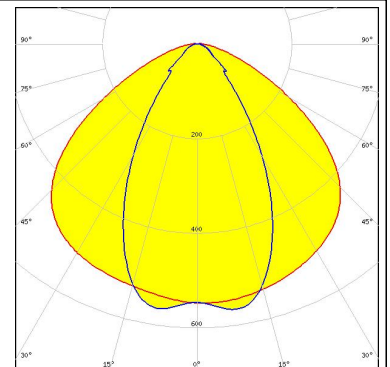

LED NF2x757G  
 FWHM 56.0 + 111.0°  
 Efficiency 93 %  
 Peak intensity 0.600 cd/lm  
 Required components:

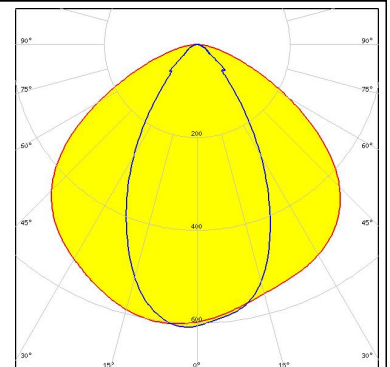

#### PHOTOMETRIC DATA (MEASURED):

**OSRAM**  
Opto Semiconductors

LED Duris E5  
FWHM 112.0 + 58.0°  
Efficiency 94 %  
Peak intensity 0.610 cd/lm  
Required components:

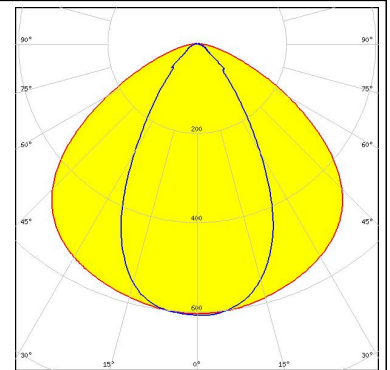
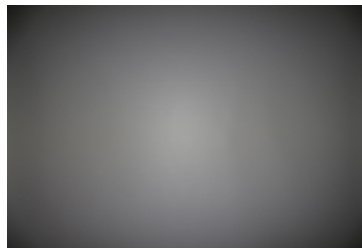

**OSRAM**  
Opto Semiconductors

LED Duris S5 (2 chip)  
FWHM 58.0 + 114.0°  
Efficiency 94 %  
Peak intensity 0.590 cd/lm  
Required components:

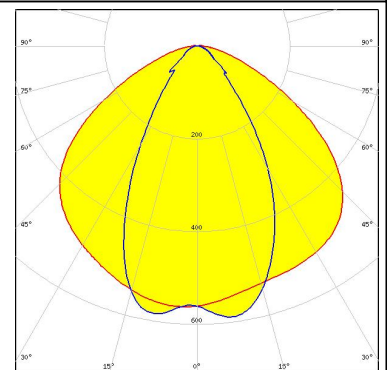

**PHILIPS**

LED Fortimo LED Line 1ft 1100lm xx0 1R xV2/x  
FWHM 58.0 + 111.0°  
Efficiency 94 %  
Peak intensity 0.600 cd/lm  
Required components:

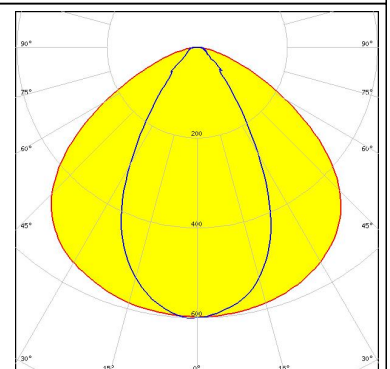
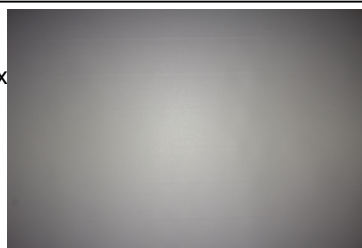

**SAMSUNG**

LED LM28xB Series  
FWHM 57.0 + 113.0°  
Efficiency 94 %  
Peak intensity 0.620 cd/lm  
Required components:

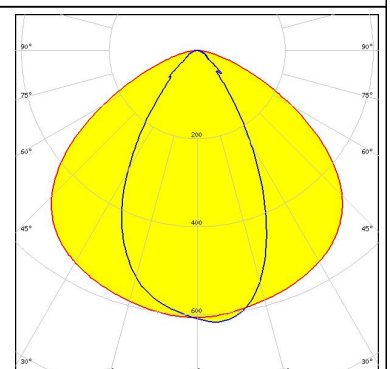
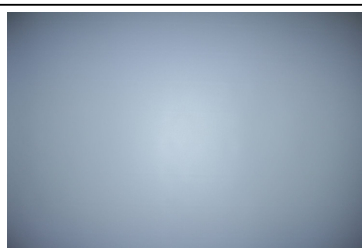

### PHOTOMETRIC DATA (MEASURED):

#### SAMSUNG

LED LM301A  
FWHM 56.0 + 113.0°  
Efficiency 94 %  
Peak intensity 0.640 cd/lm  
Required components:

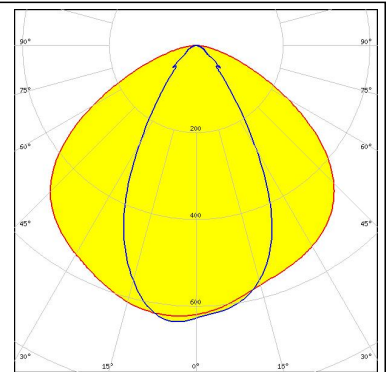

#### SAMSUNG

LED LM302A  
FWHM 59.0 + 111.0°  
Efficiency 94 %  
Peak intensity 0.600 cd/lm  
Required components:

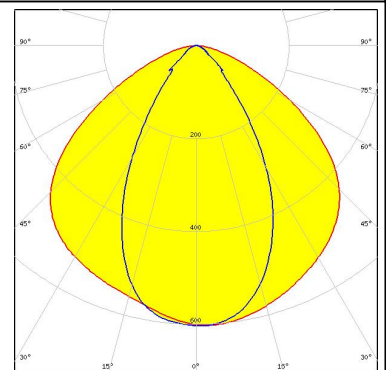

#### SAMSUNG

LED LM561B  
FWHM 59.0 + 111.0°  
Efficiency 94 %  
Peak intensity 0.580 cd/lm  
Required components:

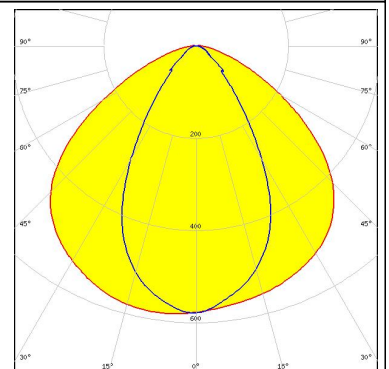
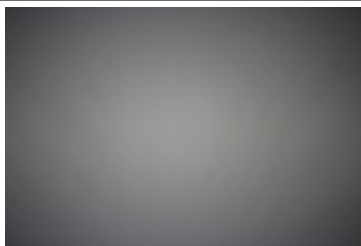

#### SAMSUNG

LED LM561C  
FWHM 56.0 + 113.0°  
Efficiency 94 %  
Peak intensity 0.630 cd/lm  
Required components:

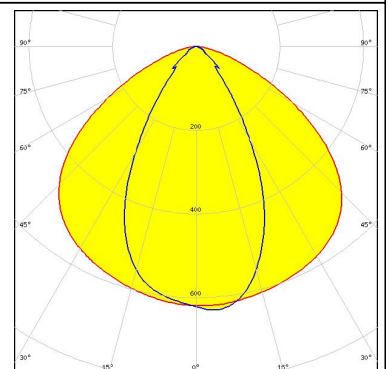
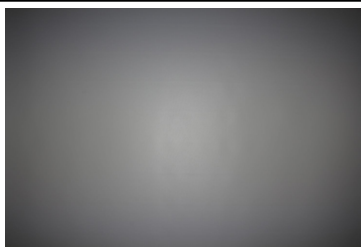

#### PHOTOMETRIC DATA (MEASURED):

### SAMSUNG

LED LT-S282N  
 FWHM 56.0 + 112.0°  
 Efficiency 94 %  
 Peak intensity 0.620 cd/lm  
 Required components:

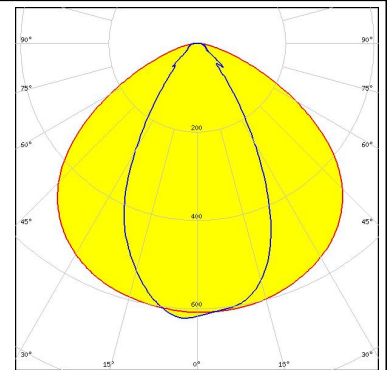

SEOUL SEMICONDUCTOR

LED SEOUL 3030  
 FWHM 59.0 + 111.0°  
 Efficiency 94 %  
 Peak intensity 0.600 cd/lm  
 Required components:

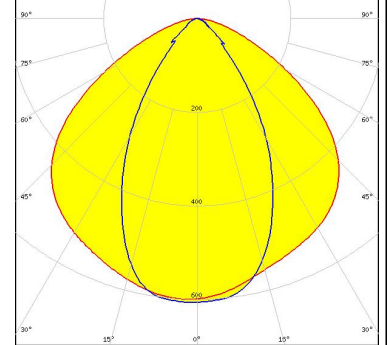
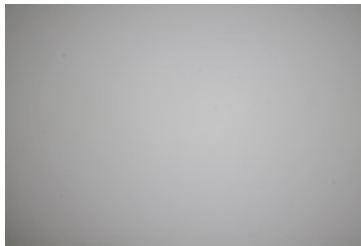

SEOUL SEMICONDUCTOR

LED SunLike 3030  
 FWHM 115.0 + 55.0°  
 Efficiency 94 %  
 Peak intensity 0.610 cd/lm  
 Required components:  
 C14353\_FLORENCE-1R-CLIP-A

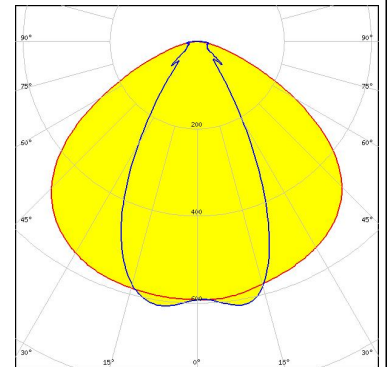
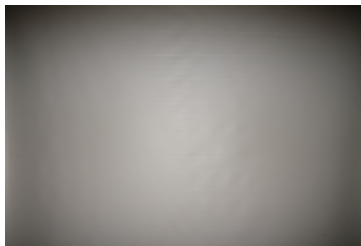



#### PHOTOMETRIC DATA (SIMULATED):



LED LUXEON 2835 Line  
FWHM 59.0 + 107.0°  
Efficiency 94 %  
Peak intensity 0.650 cd/lm  
Required components:

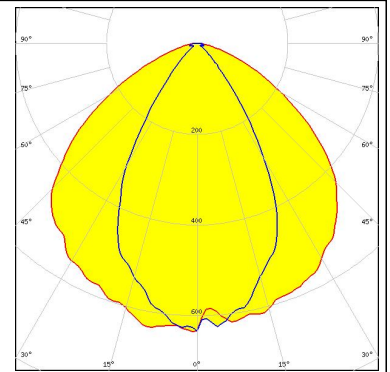

LED LUXEON 5050  
FWHM 61.0 + 107.0°  
Efficiency 94 %  
Peak intensity 0.570 cd/lm  
Required components:

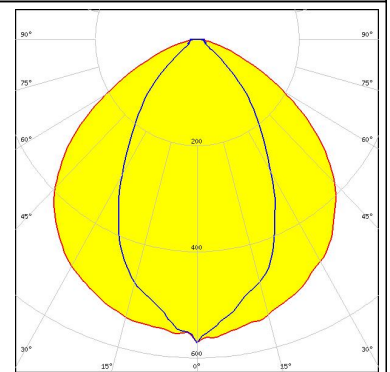

LED Duris E 2835  
FWHM 61.0 + 107.0°  
Efficiency 94 %  
Peak intensity 0.600 cd/lm  
Required components:

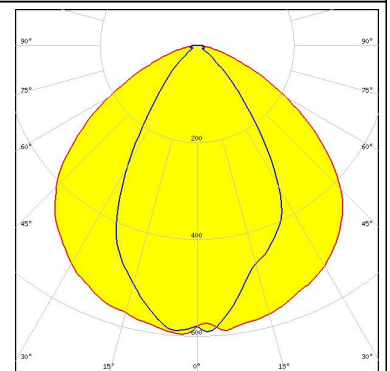

### GENERAL INFORMATION:

NOTE: The typical beam angle will be changed by different color, chip size and chip position tolerance. The typical total beam angle is the full angle measured where the luminous intensity is half of the peak value.

### MATERIALS:

As part of our continuous research and improvement processes, and to ensure the best possible quality and availability of our products, LEDiL reserves the right to change material grades without notice.

### PRODUCT DATA USER AGREEMENT AND DISCLAIMER:

The measured data in the provided downloadable LEDiL Product Datasheets and Mechanical 2D-Drawings is rounded and provided as reference for planning. LEDiL Oy's optical specifications have been verified by conducting performance testing of the products in accordance with the company's quality system. The reported data are averaged results of multiple measurements with typical variation. LEDiL Oy reserves the right to without prior notification make changes and improvements to its products.

LEDiL Oy assumes neither warranty, nor guarantee nor any other liability of any kind for the contents and correctness of the provided data. The provided data has been generated with highest diligence but the provided data may in reality not represent the complete possible variation range of all intrinsic parameters. Therefore, in certain cases a deviation from the provided data could occur.

LEDiL Oy reserves the right to undertake technical changes of its products without further notification which could lead to changes in the provided data. LEDiL Oy assumes no liability of any kind for the possible deviation from any provided data or any other damage resulting from the usage of the provided data.

The user agrees to this disclaimer and user agreement with the download or usage of the provided files.

#### LEDiL Oy

Joensuunkatu 13  
FI-24240 SALO  
Finland

#### LEDiL Inc.

228 West Page Street  
Suite D  
Sycamore IL 60178  
USA

#### Local sales and technical support

[www.ledil.com/  
where\\_to\\_buy](http://www.ledil.com/where_to_buy)

#### Shipping locations

Salo, Finland  
Hong Kong, China

#### Distribution Partners

[www.ledil.com/  
where\\_to\\_buy](http://www.ledil.com/where_to_buy)