

## Description

The ICSSSTUAF32869A is 14-bit 1:2 registered buffer with parity, designed for 1.7 V to 1.9 V VDD operation.

All clock and data inputs are compatible with the JEDEC standard for SSTL\_18. The control inputs are LVCMOS. All outputs are 1.8V CMOS drivers optimized to drive the DDR2 DIMM load. They provide 50% more dynamic driver strength than the standard SSTU32864 outputs.

The ICSSSTUAF32869A operates from a differential clock (CLK and  $\overline{\text{CLK}}$ ). Data are registered at the crossing of CLK going high, and  $\overline{\text{CLK}}$  going low.

The device supports low-power standby operation. When the reset input ( $\overline{\text{RESET}}$ ) is low, the differential input receivers are disabled, and undriven (floating) data, clock and reference voltage (VREF) inputs are allowed. In addition, when  $\overline{\text{RESET}}$  is low all registers are reset, and all outputs except  $\overline{\text{PTYERR}}$  are forced low. The LVCMOS  $\overline{\text{RESET}}$  input must always be held at a valid logic high or low level.

To ensure defined outputs from the register before a stable clock has been supplied,  $\overline{\text{RESET}}$  must be held in the low state during power up.

In the DDR2 RDIMM application,  $\overline{\text{RESET}}$  is specified to be completely asynchronous with respect to CLK and  $\overline{\text{CLK}}$ . Therefore, no timing relationship can be guaranteed between the two. When entering reset, the register will be cleared and the outputs will be driven low quickly, relative to the time to disable the differential input receivers. However, when coming out of reset, the register will become active quickly, relative to the time to enable the differential input receivers. ICSSSTUAF32869A must ensure that the outputs remain low as long as the data inputs are low, the clock is stable during the time from the low-to-high transition of  $\overline{\text{RESET}}$  and the input receivers are fully enabled. This will ensure that there are no glitches on the output.

The device monitors both  $\overline{\text{DCS}}$  and  $\overline{\text{CSR}}$  inputs and will gate the Qn, PPO (Parital-Parity-Out) and  $\overline{\text{PTYERR}}$  (Parity Error) Parity outputs from changing states when both  $\overline{\text{DCS}}$  and  $\overline{\text{CSR}}$  are high. If either  $\overline{\text{DCS}}$  and  $\overline{\text{CSR}}$  input is low, the Qn, PPO and  $\overline{\text{PTYERR}}$  outputs will function normally. The  $\overline{\text{RESET}}$  input has priority over the  $\overline{\text{DCS}}$  and  $\overline{\text{CSR}}$  controls and will force the Qn and PPO outputs low and the  $\overline{\text{PTYERR}}$  high.

The ICSSSTUAF32869A includes a parity checking function. The ICSSSTUAF32869A accepts a parity bit from the memory controller at its input pin PARIN one or two cycles after the corresponding data input, compares it with the data received on the D-inputs and indicates on its opendrain  $\overline{\text{PTYERR}}$  pin (active low) whether a parity error has occurred. The number of cycles depends on the setting of C1.

When used as a single device, the C1 input is tied low. When used in pairs, the C1 inputs is tied low for the first register (front) and the C1 input is tied high for the second register. When used as a single register, the PPO and  $\overline{\text{PTYERR}}$  signals are produced two clock cycles after the corresponding data input. When used in pairs, the  $\overline{\text{PTYERR}}$  signals of the first register are left floating. The PPO outputs of the first register are cascaded to the PARIN signals on the second register (back). The PPO and  $\overline{\text{PTYERR}}$  signals of the second register are produced three clock cycles after the corresponding data input. Parity implementation and device wiring for single and dual die is described in the diagram below.

If an error occurs, and the  $\overline{\text{PTYERR}}$  is driven low, it stays low for two clock cycles or until  $\overline{\text{RESET}}$  is driven low. The DIMM-dependent signals (DCKE, DCS, CSR and DODT) are not included in the parity check computations.

All registers used on an individual DIMM must be of the same configuration, i.e single or dual die.

## Features

- 14-bit 1:2 registered buffer with parity check functionality
- Supports SSTL\_18 JEDEC specification on data inputs and outputs
- 50% more dynamic driver strength than standard SSTU32864
- Supports LVCMOS switching levels on C1 and  $\overline{\text{RESET}}$  inputs
- Low voltage operation: VDD = 1.7V to 1.9V
- Available in 150 BGA package

## Applications

- DDR2 Memory Modules
- Provides complete DDR DIMM solution with ICS98ULPA877A or IDTCSPUA877A
- Ideal for DDR2 400, 533, and 667

### Parity Implementation and Device Wiring

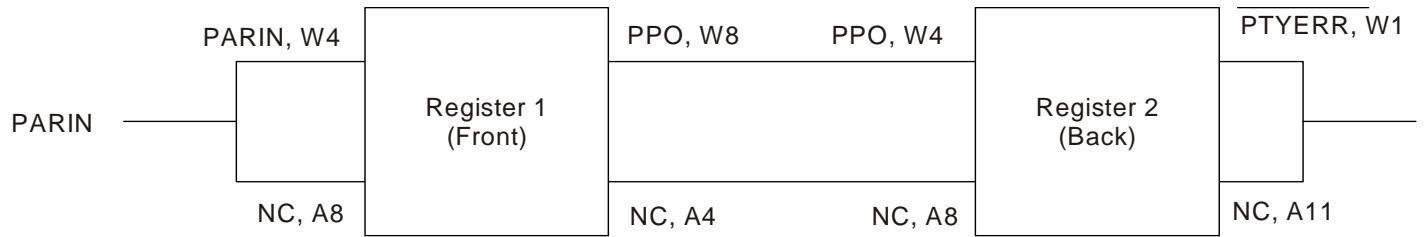

Set C=0 for Register 1, and C=1 for Register 2

### Block Diagram

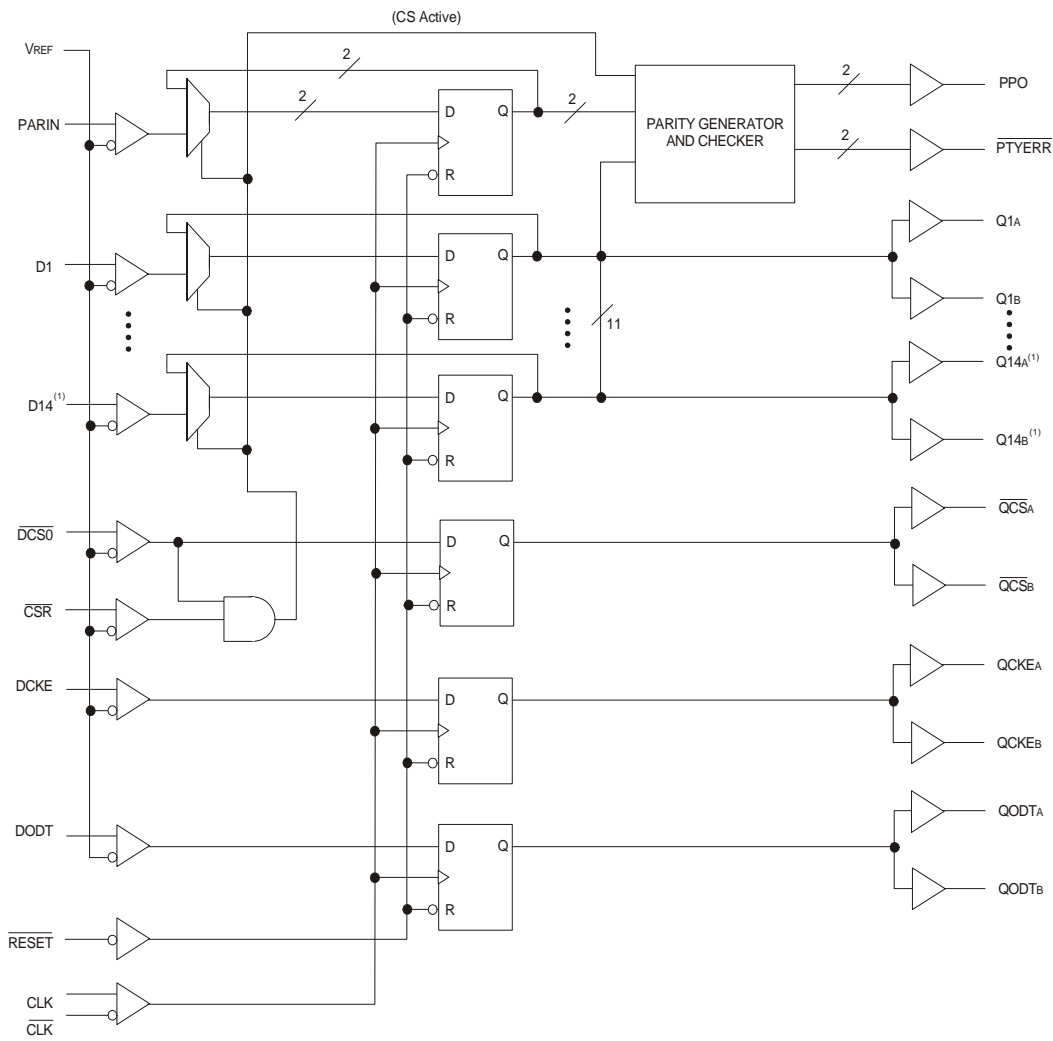

**NOTE:**

1. This range does not include D1, D4, and D7, and their corresponding outputs.

### Block Diagram

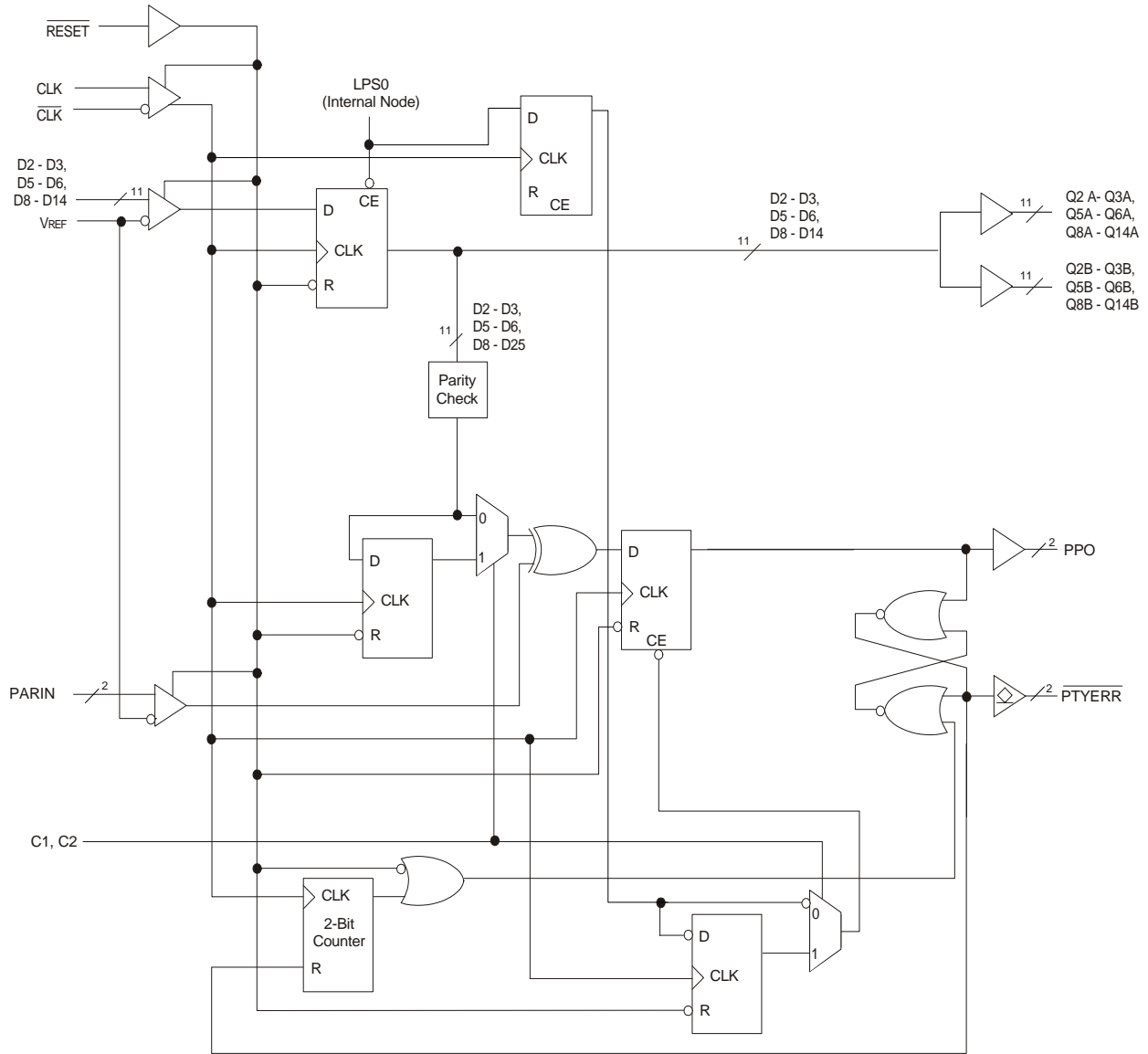

**NOTE:**

1. PARIN is used to generate PPO and  $\overline{PTYERR}$ .

## Pin Configuration

	1	2	3	4	5	6	7	8	9	10	11
A	NB	V <sub>DD</sub>	MCL <sup>(1)</sup>	NC	GND	V <sub>REF</sub>	GND	NC	MCL <sup>(1)</sup>	V <sub>DD</sub>	NC
B	V <sub>DD</sub>	NB	V <sub>DD</sub>	GND	GND	GND	GND	GND	V <sub>DD</sub>	NB	V <sub>DD</sub>
C	QCKEA	V <sub>DD</sub>	NB	GND	NB	GND	NB	GND	NB	V <sub>DD</sub>	QCKEB
D	Q2A	V <sub>DD</sub>	GND	NB	DCKE	NB	D2	NB	GND	V <sub>DD</sub>	Q2B
E	Q3A	V <sub>DD</sub>	NB	D3	NB	NC	NB	DODT	NB	C1	Q3B
F	QODTA	V <sub>DD</sub>	GND	NB	NC	NB	NC	NB	GND	V <sub>DD</sub>	QODTB
G	Q5A	V <sub>DD</sub>	GND	D5	NB	CLK	NB	D6	GND	V <sub>DD</sub>	Q5B
H	Q6A	NB	GND	NB	NC	NB	NC	NB	GND	NB	Q6B
J	$\overline{\text{QCSA}}$	V <sub>DD</sub>	NB	NC	NB	$\overline{\text{RESET}}$	NB	$\overline{\text{CSR}}$	NB	V <sub>DD</sub>	$\overline{\text{QCSB}}$
K	V <sub>DD</sub>	V <sub>DD</sub>	GND	GND	NB	NB	NB	GND	V <sub>DD</sub>	V <sub>DD</sub>	V <sub>DD</sub>
L	Q8A	V <sub>DD</sub>	NB	$\overline{\text{DCS}}$	NB	$\overline{\text{CLK}}$	NB	D8	NB	V <sub>DD</sub>	Q8B
M	Q9A	NB	GND	NB	NC	NB	NC	NB	GND	NB	Q9B
N	Q10A	V <sub>DD</sub>	GND	D9	NB	NC	NB	D10	GND	V <sub>DD</sub>	Q10B
P	Q11A	V <sub>DD</sub>	GND	NB	NC	NB	NC	NB	GND	V <sub>DD</sub>	Q11B
R	Q12A	C1	NB	D11	NB	NC	NB	D12	NB	V <sub>DD</sub>	Q12B
T	Q13A	V <sub>DD</sub>	GND	NB	D13	NB	D14	NB	GND	V <sub>DD</sub>	Q13B
U	Q14A	V <sub>DD</sub>	NB	GND	NB	GND	NB	GND	NB	V <sub>DD</sub>	Q14B
V	V <sub>DD</sub>	NB	V <sub>DD</sub>	GND	GND	GND	GND	GND	V <sub>DD</sub>	NB	V <sub>DD</sub>
W	$\overline{\text{PTYERR}}$	V <sub>DD</sub>	MCL <sup>(1)</sup>	PARIN	GND	V <sub>REF</sub>	GND	PPO	MCL <sup>(1)</sup>	V <sub>DD</sub>	NB

### 150-Ball BGA TOP VIEW

#### NOTE:

1.NC denotes a no-connect (ball present but not connected to the die). NB indicates no ball is populated at that gridpoint.

### 150 Ball CTBGA Package Attributes

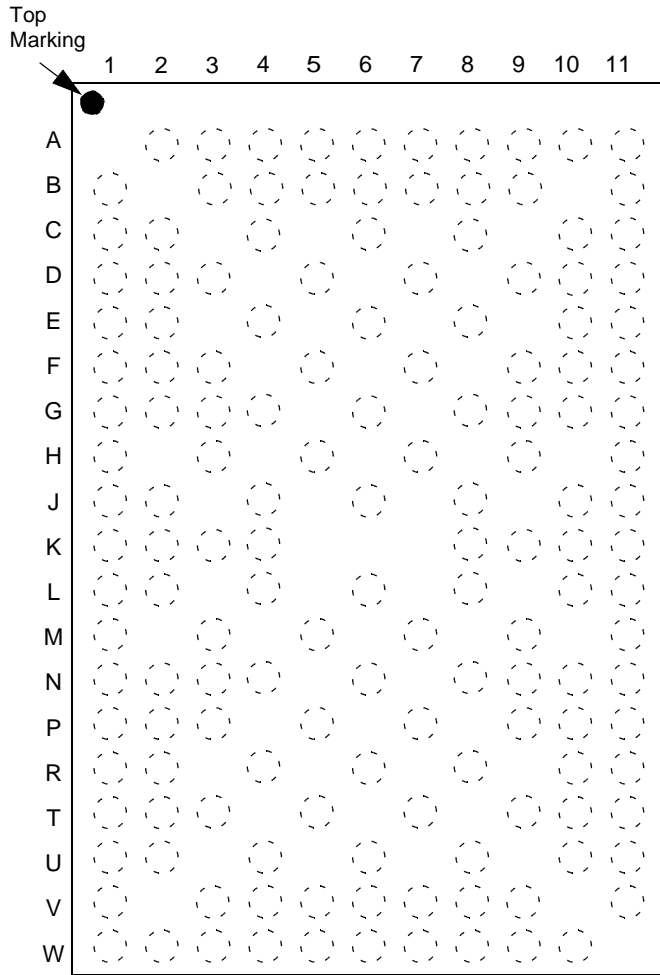

TOP VIEW

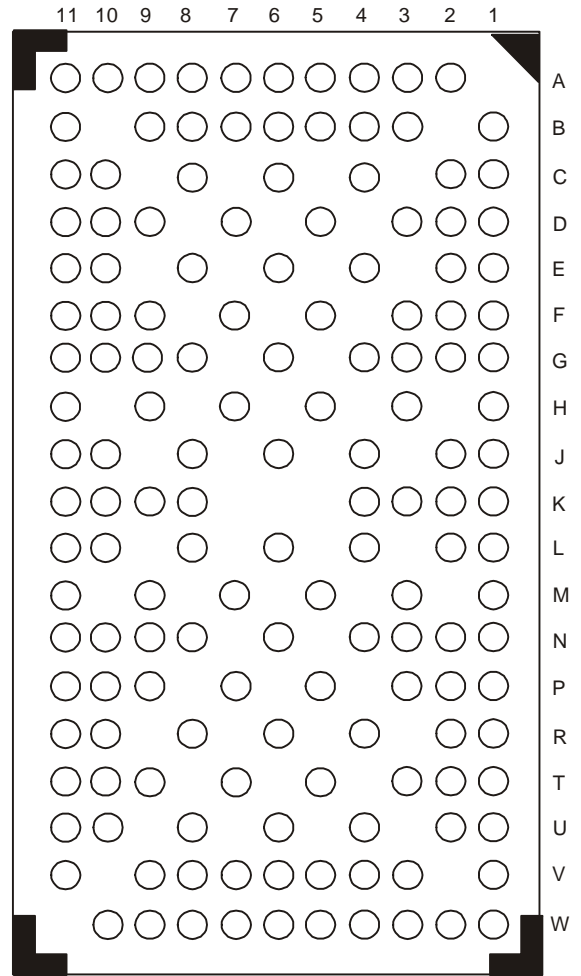

BOTTOM VIEW

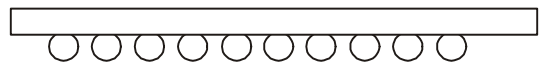

SIDE VIEW

## Function Table

Inputs <sup>1</sup>						Outputs		
$\overline{\text{RESET}}$	$\overline{\text{DCS}}$	$\overline{\text{CSR}}$	CLK	$\overline{\text{CLK}}$	Dn, DODT, DCKE	Qn	$\overline{\text{QCS}}$	QODT, QCKE
H	L	L	↑	↓	L	L	L	L
H	L	L	↑	↓	H	H	L	H
H	L	L	L or H	L or H	X	$Q_0^2$	$Q_0^2$	$Q_0^2$
H	L	H	↑	↓	L	L	L	L
H	L	H	↑	↓	H	H	L	H
H	L	H	L or H	L or H	X	$Q_0^2$	$Q_0^2$	$Q_0^2$
H	H	L	↑	↓	L	L	H	L
H	H	L	↑	↓	H	H	H	H
H	H	L	L or H	L or H	X	$Q_0^2$	$Q_0^2$	$Q_0^2$
H	H	H	↑	↓	L	$Q_0^2$	H	L
H	H	H	↑	↓	H	$Q_0^2$	H	H
H	H	H	L or H	L or H	X	$Q_0^2$	$Q_0^2$	$Q_0^2$
L	X or Floating	X or Floating	X or Floating	X or Floating	X or Floating	L	L	L

1 H = HIGH Voltage Level

L = LOW Voltage Level

X = Don't Care

↑ = LOW to HIGH

↓ = HIGH to LOW

2 Output Level before the indicated steady-state conditions were established.

## Terminal Functions

Signal Group	Terminal Name	Type	Description
Ungated Inputs	DCKE, DODT	SSTL_18	DRAM function pins not associated with Chip Select
Chip Select Gated Inputs	D1...D14 <sup>1</sup>	SSTL_18	DRAM inputs, re-driven only when Chip Select is LOW
Chip Select Inputs	$\overline{\text{DCS}}$ , $\overline{\text{CSR}}$	SSTL_18	DRAM Chip Select signals. These pins initiate DRAM address/command decodes, and as such at least one will be LOW when a valid address/command is present.
Re-Driven Outputs	Q1A...Q14A <sup>1</sup> , Q1B...Q14B <sup>1</sup> , $\overline{\text{QCSnA}}$ , B QCKEnA, B QODTnA, B	SSTL_18	Outputs of the register, valid after the specified clock count and immediately following a rising edge of the clock
Parity Input	PARIN	SSTL_18	Input parity is received on pin PARIN, and should maintain odd parity across the D1:D14 inputs, at the rising edge of the clock, one cycle after Chip Select is LOW.
Parity Output	PPO	SSTL_18	Partial Parity Output. Indicates parity out of D1-D14.
Parity Error Output	$\overline{\text{PTYERR}}$	Open Drain	When LOW, this output indicates that a parity error was identified associated with the address and/or command inputs. $\overline{\text{PTYERR}}$ will be active for two clock cycles, and delayed by in total two clock cycles for compatibility with final parity out timing on the industry-standard DDR2 register with parity (in JEDEC definition).
Configuration Inputs	C1	SSTL_18	When LOW, the register is configured as Register 1. When HIGH, the register is configured as Register 2.
Clock Inputs	CLK, $\overline{\text{CLK}}$	SSTL_18	Differential master clock input pair to the register. The register operation is triggered by a rising edge on the positive clock input (CLK).
Miscellaneous Inputs	$\overline{\text{RESET}}$	SSTL_18 Input	Asynchronous Reset Input. When LOW, it causes a reset of the internal latches, thereby forcing the outputs LOW. $\overline{\text{RESET}}$ also resets the $\overline{\text{PTYERR}}$ signal.
	VREF	0.9V nominal	Input reference voltage for SSTL_18 inputs. Two pins (internally tied together) are used for increased Inputsreliability.
	VDD	Power Input	Power Supply Voltage
	GND	Ground Input	Ground

<sup>1</sup> This range does not include D1, D4, and D7, and their corresponding outputs.

## Parity and Standby Function Table

Inputs <sup>1</sup>							Outputs	
$\overline{\text{RESET}}$	$\overline{\text{DCS}}$	$\overline{\text{CSR}}$	CLK	$\overline{\text{CLK}}$	$\Sigma$ of Inputs = H (D1 - D14) <sup>2</sup>	PARIN <sup>3</sup>	PPO	$\overline{\text{PTYERR}}$ <sup>4</sup>
H	L	X	↑	↓	Even	L	L	H
H	L	X	↑	↓	Odd	L	H	L
H	L	X	↑	↓	Even	H	H	L
H	L	X	↑	↓	Odd	H	L	H
H	L	L	↑	↓	Even	L	L	H
H	L	L	↑	↓	Odd	L	H	L
H	L	L	↑	↓	Even	H	H	L
H	L	L	↑	↓	Odd	H	L	H
H	H	H	↑	↓	X	X	PPO <sub>n0</sub>	$\overline{\text{PTYERR}}_{n0}$
H	X	X	L or H	L or H	X	X	PPO <sub>n0</sub>	$\overline{\text{PTYERR}}_{n0}$
L	X or Floating	X or Floating	X or Floating	X or Floating	X or Floating	X or Floating	L	H

1 H = HIGH Voltage Level

L = LOW Voltage Level

X = Don't Care

↑ = LOW to HIGH

↓ = HIGH to LOW

2 This range does not include D1, D4, and D7.

3 PARIN arrives one clock cycle (C1 = 0), or two clock cycles (C1 = 1), after the data to which it applies.

4 This transition assumes  $\overline{\text{PTYERR}}$  is HIGH at the crossing of CLK going HIGH and  $\overline{\text{CLK}}$  going LOW. If  $\overline{\text{PTYERR}}$  is LOW, it stays latched LOW for two clock cycles or until  $\overline{\text{RESET}}$  is driven LOW. PARIN is used to generate PPO and  $\overline{\text{PTYERR}}$ .



## Absolute Maximum Ratings

Stresses greater than those listed under ABSOLUTE MAXIMUM RATINGS may cause permanent damage to the device. This is a stress rating only and functional operation of the device at these or any other conditions above those indicated in the operational sections of this specification is not implied. Exposure to absolute maximum rating conditions for extended periods may affect reliability.

Item		Rating
Supply Voltage, VDD		-0.5V to 2.5V
Input Voltage Range, Vi <sup>1</sup>		-0.5V to VDD + 2.5V
Output Voltage Range, Vo <sup>1,2</sup>		-0.5V to VDDQ + 0.5V
Input Clamp Current, IiK		±50mA
Output Clamp Current, IOK		±50mA
Continuous Output Clamp Current, Io		±50mA
Continuous Current through each VDD or GND		±100mA
Package Thermal Impedance ( $\theta_{ja}$ ) <sup>3</sup>	0m/s Airflow	40° C/W
	1m/s Airflow	29° C/W
Storage Temperature		-65 to +150° C

1 The input and output negative voltage ratings may be exceeded if the ratings of the I/P and O/P clamp current are observed.

2 This current will flow only when the output is in the high state level  $V_O > V_{DDQ}$ .

3 The package thermal impedance is calculated in accordance with JESD 51.

## Mode Select

C1	Device Mode
0	First device in pair, Front
1	Second device in pair, Back

## Output Buffer Characteristics

Output edge rates over recommended operating free-air temperature range

Parameter	VDD = 1.8V ± 0.1V		Units
	Min.	Max.	
dV/dt_r	1	4	V/ns
dV/dt_f	1	4	V/ns
dV/dt_Δ <sup>1</sup>		1	V/ns

1 Difference between dV/dt\_r (rising edge rate) and dV/dt\_f (falling edge rate).

## Operating Characteristics, $T_A = 25^\circ\text{C}$

The  $\overline{\text{RESET}}$  and Cn inputs of the device must be held at valid levels (not floating) to ensure proper device operation. The differential inputs must not be floating unless  $\overline{\text{RESET}}$  is LOW.

Symbol	Parameter	Min.	Typ.	Max.	Units
VDD	I/O Supply Voltage	1.7	1.8	1.9	V
VREF	Reference Voltage	$0.49 * V_{DD}$	$0.5 * V_{DD}$	$0.51 * V_{DD}$	V
VTT	Termination Voltage	$V_{REF} - 0.04$	VREF	$V_{REF} + 0.04$	V
Vi	Input Voltage	0		VDD	V
VIH	AC High-Level Input Voltage	$V_{REF} + 0.25$			V
VIL	AC Low-Level Input Voltage				
VIH	DC High-Level Input Voltage				
VIL	DC Low-Level Input Voltage				
VIH	High-Level Input Voltage	$0.65 * V_{DDQ}$			V
VIL	Low-Level Input Voltage				
VICR	Common Mode Input Range	600		1.125	V
VID	Differential Input Voltage				mV
IOH	High-Level Output Current			-12	mA
IOL	Low-Level Output Current			12	
IERRLOL	$\overline{\text{PTYERR}}$ Low-Level Output Current	25			mA
TA	Operating Free-Air Temperature	0		+70	$^\circ\text{C}$

## DC Electrical Characteristics Over Operating Range

Following Conditions Apply Unless Otherwise Specified:

Operating Condition:  $T_A = 0^{\circ}\text{C}$  to  $+70^{\circ}\text{C}$ ,  $V_{DDQ}/V_{DD} = 1.8\text{V} \pm 0.1\text{V}$ .

Symbol	Parameter	Test Conditions	Min.	Typ.	Max.	Units
$V_{IK}$		$I_I = -18\text{mA}$			-1.2	V
$V_{OH}$		$V_{DDQ} = 1.7\text{V}$ , $I_{OH} = -100\mu\text{A}$	$V_{DDQ}-0.2$			V
		$V_{DDQ} = 1.7\text{V}$ , $I_{OH} = -12\text{mA}$	1.2			
$V_{OL}$		$V_{DDQ} = 1.7\text{V}$ , $I_{OL} = 100\mu\text{A}$			0.2	V
		$V_{DDQ} = 1.7\text{V}$ , $I_{OL} = 12\text{mA}$			0.5	
$V_{ERROL}$	$\overline{\text{PTYERR}}$ Output Low Voltage	$I_{ERROL} = 25\text{mA}$ ; $V_{DD} = 1.7\text{V}$			0.5	V
$I_{IL}$	All Inputs	$V_I = V_{DD}$ or GND	-5		+5	$\mu\text{A}$
$I_{DD}$	Static Standby	$I_O = 0$ , $V_{DD} = 1.9\text{V}$ , $\overline{\text{RESET}} = \text{GND}$			200	$\mu\text{A}$
	Static Operating	$I_O = 0$ , $V_{DD} = 1.9\text{V}$ , $\overline{\text{RESET}} = V_{DD}$ , $V_I = V_{IH(AC)}$ or $V_{IL(AC)}$ , $\text{CLK} = \overline{\text{CLK}} = V_{IH(AC)}$ or $V_{IL(AC)}$			10	mA
		$I_O = 0$ , $V_{DD} = 1.9\text{V}$ , $\overline{\text{RESET}} = V_{DD}$ , $V_I = V_{IH(AC)}$ or $V_{IL(AC)}$ , $\text{CLK} = V_{IH(AC)}$ , $\overline{\text{CLK}} = V_{IL(AC)}$		120		
$I_{DDD}$	Dynamic Operating (clock only)	$I_O = 0$ , $V_{DD} = 1.8\text{V}$ , $\overline{\text{RESET}} = V_{DD}$ , $V_I = V_{IH(AC)}$ or $V_{IL(AC)}$ , $\text{CLK}$ and $\overline{\text{CLK}}$ switching 50% duty cycle		247		$\mu\text{A}/\text{Clock MHz}$
	Dynamic Operating (per each data input)	$I_O = 0$ , $V_{DD} = 1.8\text{V}$ , $\overline{\text{RESET}} = V_{DD}$ , $V_I = V_{IH(AC)}$ or $V_{IL(AC)}$ , $\text{CLK}$ and $\overline{\text{CLK}}$ switching 50% duty cycle. One data input switching at half clock frequency, 50% duty cycle.		52		$\mu\text{A}/\text{Clock MHz}/\text{Data}$
$C_{IN}$	$D_n$ , $\text{PARIN}$ , $\overline{\text{DSCn}}$ inputs	$V_I = V_{REF} \pm 250\text{mV}$	2		3	pF
	$\text{CLK}$ and $\overline{\text{CLK}}$ inputs	$V_{ICR} = 0.9\text{V}$ , $V_{IPP} = 600\text{mV}$	3.5		4.5	
	$\overline{\text{RESET}}$	$V_I = V_{DD}$ or GND		5		

## Timing Requirements Over Recommended Operating Free-Air Temperature Range

Symbol	Parameter	VDD = 1.8V ± 0.1V		Units
		Min.	Max.	
fCLOCK	Clock Frequency		410	MHz
tW	Pulse Duration, CLK, $\overline{\text{CLK}}$ HIGH or LOW	1		ns
tACT <sup>1</sup>	Differential Inputs Active Time		10	ns
tINACT <sup>2</sup>	Differential Inputs Inactive Time		15	ns
tSU	Setup Time	$\overline{\text{DCS}}$ before CLK $\uparrow$ , $\overline{\text{CLK}}\downarrow$ , $\overline{\text{CSR}}$ HIGH; $\overline{\text{CSR}}$ before CLK $\uparrow$ , $\overline{\text{CLK}}\downarrow$ , $\overline{\text{DCS}}$ HIGH	0.7	ns
		$\overline{\text{DCS}}$ before CLK $\uparrow$ , $\overline{\text{CLK}}\downarrow$ , $\overline{\text{CSR}}$ LOW	0.5	
		DODT, DOCKE, and data before CLK $\uparrow$ , $\overline{\text{CLK}}\downarrow$	0.5	
		PAR_IN before CLK $\uparrow$ , $\overline{\text{CLK}}\downarrow$	0.5	
tH	Hold Time	$\overline{\text{DCS}}$ , DODT, DCKE, and data after CLK $\uparrow$ , $\overline{\text{CLK}}\downarrow$	0.5	ns
		PAR_IN after CLK $\uparrow$ , $\overline{\text{CLK}}\downarrow$	0.5	

1 VREF must be held at a valid input voltage level and data inputs must be held at valid logic levels for a minimum time of tACT(max) after RESET is taken HIGH.

2 VREF, data, and clock inputs must be held at a valid input voltage levels (not floating) for a minimum time of tINACT(max) after RESET is taken LOW.

## Switching Characteristics Over Recommended Free Air Operating Range (unless otherwise noted)

Symbol	Parameter	VDD = 1.8V ± 0.1V		Units
		Min.	Max.	
fMAX	Max Input Clock Frequency	340		MHz
tPDM	Propagation Delay, single-bit switching, CLK $\uparrow$ / $\overline{\text{CLK}}\downarrow$ to Qn	1.1	1.9	ns
tPDMSS	Propagation Delay, simultaneous switching, CLK $\uparrow$ / $\overline{\text{CLK}}\downarrow$ to Qn		2	ns
tLH	LOW to HIGH Propagation Delay, CLK $\uparrow$ / $\overline{\text{CLK}}\downarrow$ to $\overline{\text{PTYERR}}$	0.9	3	ns
tHL	HIGH to LOW Propagation Delay, CLK $\uparrow$ / $\overline{\text{CLK}}\downarrow$ to $\overline{\text{PTYERR}}$	0.4	2.4	ns
tPD	Propagation Delay from CLK $\uparrow$ / $\overline{\text{CLK}}\downarrow$ to PPO	0.3	1.6	ns
tPHL	HIGH to LOW Propagation Delay, $\overline{\text{RESET}}\downarrow$ to Qn $\downarrow$		3	ns
tPLH	LOW to HIGH Propagation Delay, $\overline{\text{RESET}}\downarrow$ to $\overline{\text{PTYERR}}\uparrow$		3	ns

## Output Buffer Characteristics

Output edge rates over recommended operating free-air temperature range

Parameter	VDD = 1.8V ± 0.1V		Units
	Min.	Max.	
dV/dt <sub>r</sub>	1	4	V/ns
dV/dt <sub>f</sub>	1	4	V/ns
dV/dt <sub>Δ</sub> <sup>1</sup>		1	V/ns

1 Difference between dV/dt<sub>r</sub> (rising edge rate) and dV/dt<sub>f</sub> (falling edge rate).

## Register Timing

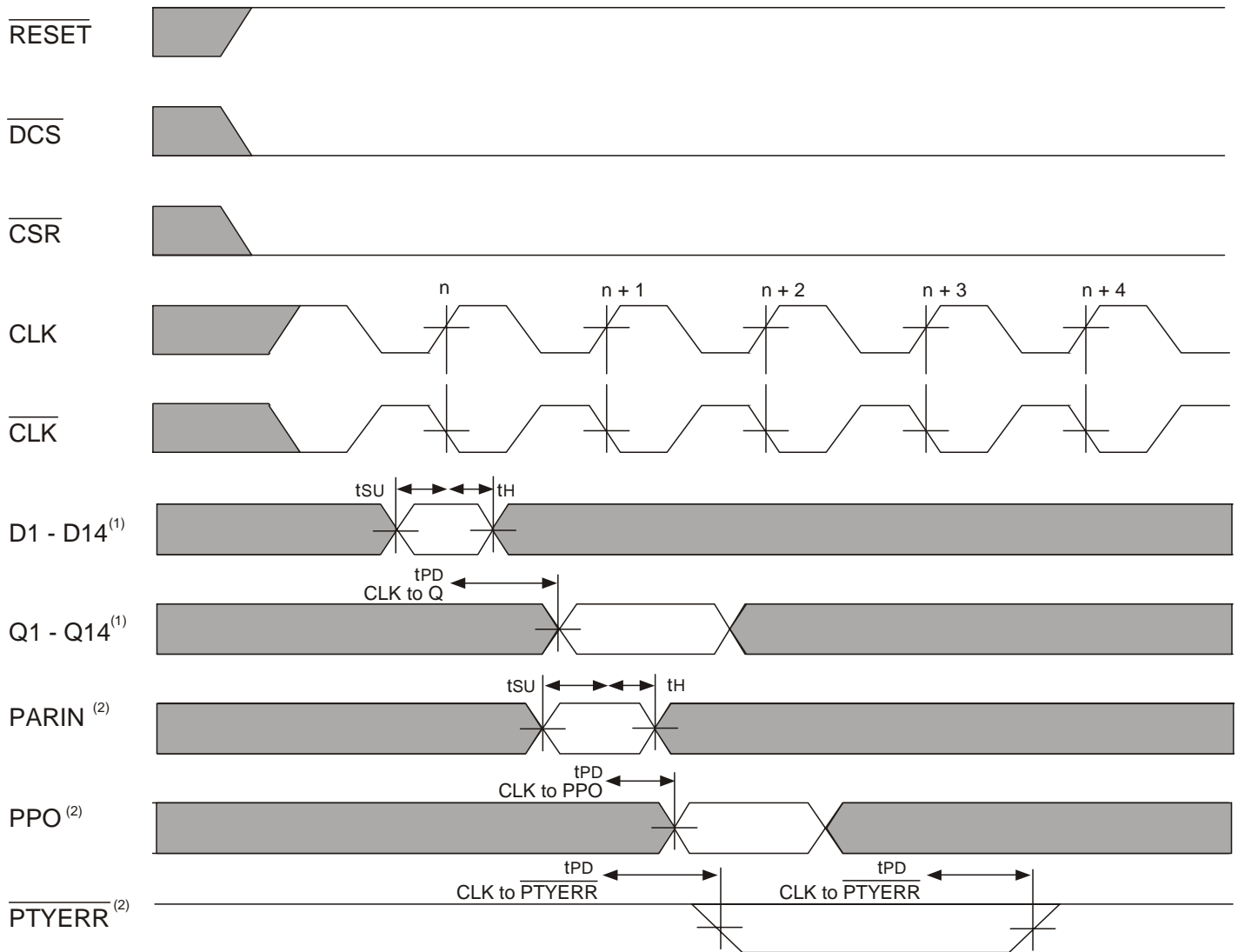

**NOTES:**

1. This range does not include D1, D4, and D7, and their corresponding outputs.
2. PARIN is used to generate PPO and  $\overline{PTYERR}$ .

### Register Timing

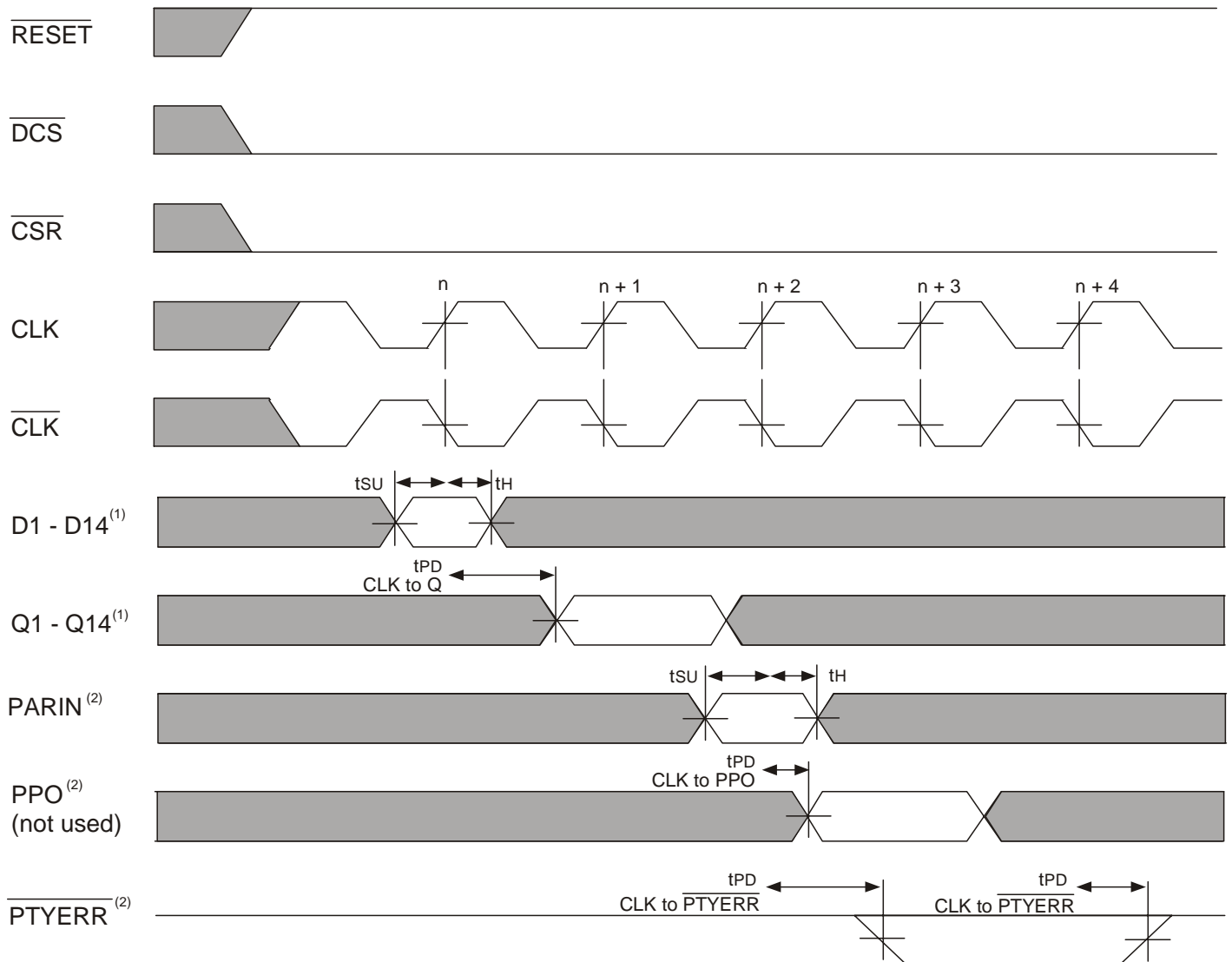

**NOTES:**

1. This range does not include D1, D4, and D7, and their corresponding outputs.
2. PARIN is used to generate PPO and  $\overline{PTYERR}$ .

### Test Circuits and Waveforms ( $V_{DD} = 1.8V \pm 0.1V$ )

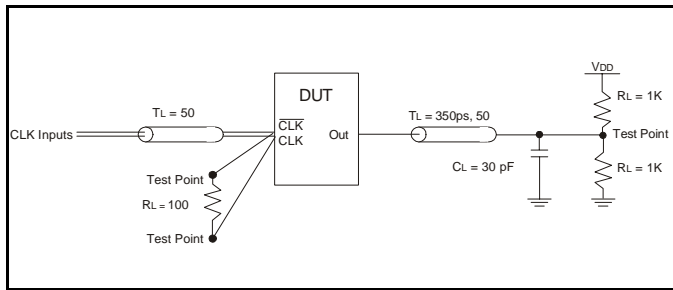

Simulation Load Circuit

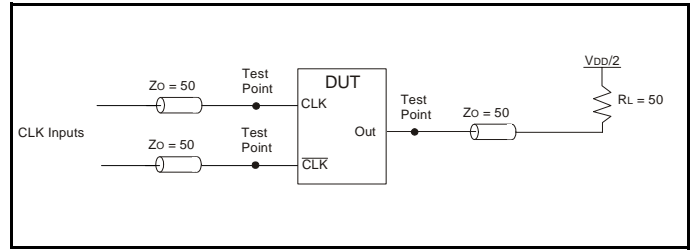

Production-Test Load Circuit

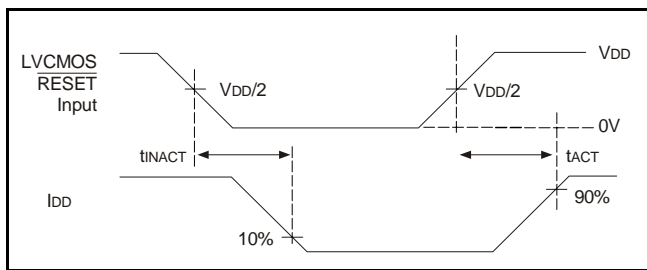

Voltage and Current Waveforms Inputs Active and Inactive Times

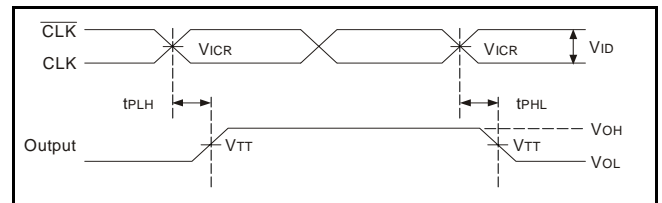

Voltage Waveforms - Propagation Delay Times

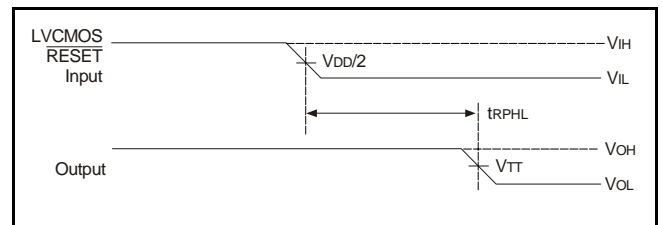

Voltage Waveforms - Propagation Delay Times

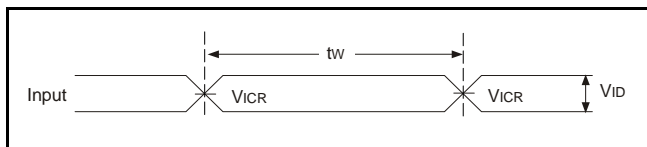

Voltage Waveforms - Pulse Duration

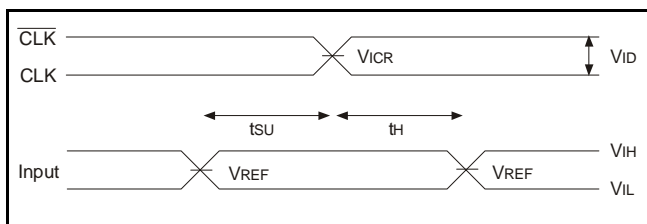

Voltage Waveforms - Setup and Hold Times

NOTES:

1. CL includes probe and jig capacitance.
2. IDD tested with clock and data inputs held at VDD or GND, and  $I_o = 0mA$
3. All input pulses are supplied by generators having the following characteristics: PRR  $\leq 10MHz$ ,  $Z_o = 50\Omega$ , input slew rate =  $1 V/ns \pm 20\%$  (unless otherwise specified).
4. The outputs are measured one at a time with one transition per measurement.
5.  $V_{TT} = V_{REF} = V_{DD}/2$
6.  $V_{IH} = V_{REF} + 250mV$  (AC voltage levels) for differential inputs.  $V_{IH} = V_{DD}$  for LVC MOS input.
7.  $V_{IL} = V_{REF} - 250mV$  (AC voltage levels) for differential inputs.  $V_{IL} = GND$  for LVC MOS input.
8.  $V_{ID} = 600mV$ .
9. tPLH and tPHL are the same as tPDM.



### Test Circuits and Waveforms ( $V_{DD} = 1.8V \pm 0.1V$ )

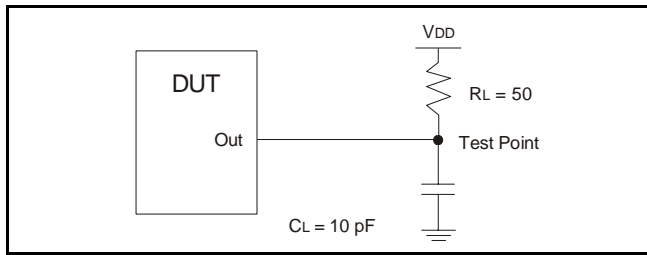

**Load Circuit: High-to-Low Slew-Rate Adjustment**

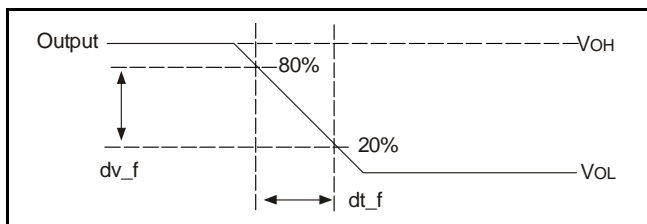

**Voltage Waveforms: High-to-Low Slew-Rate Adjustment**

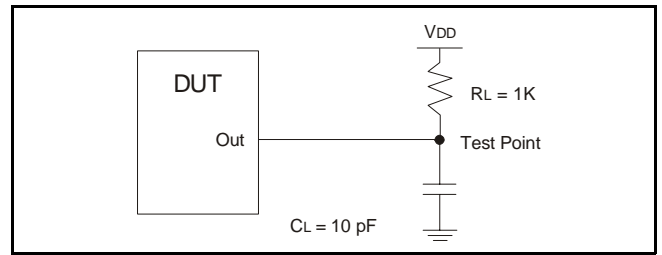

**Load Circuit: Error Output Measurements**

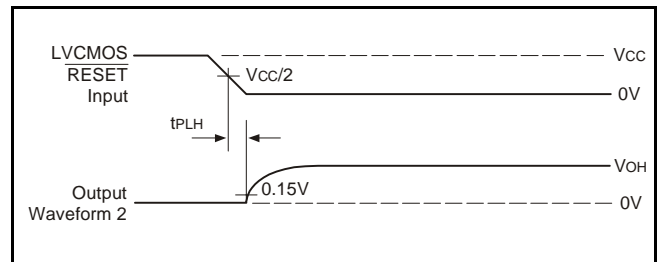

**Voltage Waveforms: Open Drain Output Low-to-High Transition Time (with respect to RESET input)**

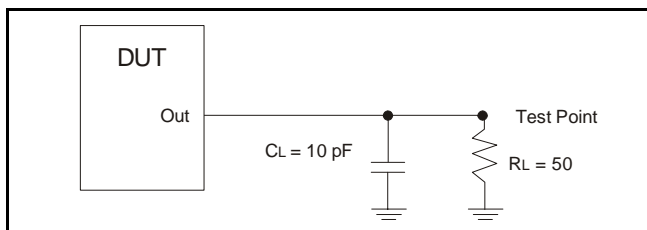

**Load Circuit: Low-to-High Slew-Rate Adjustment**

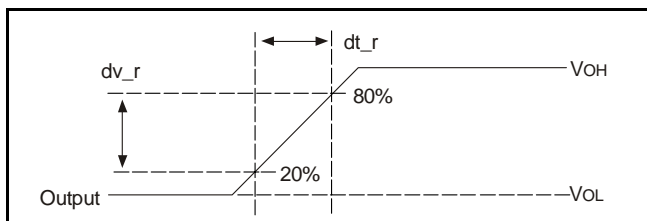

**Voltage Waveforms: Low-to-High Slew-Rate Adjustment**

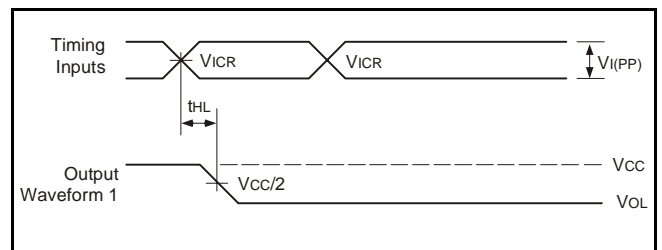

**Voltage Waveforms: Open Drain Output High-to-Low Transition Time (with respect to clock inputs)**

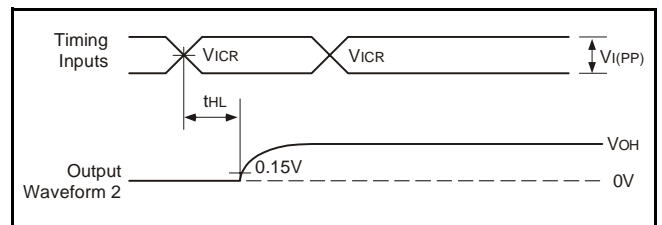

**Voltage Waveforms: Open Drain Output Low-to-High Transition Time (with respect to clock inputs)**

**NOTES:**

1. CL includes probe and jig capacitance.
2. All input pulses are supplied by generators having the following characteristics: PRR  $\leq 10\text{MHz}$ ,  $Z_o = 50\Omega$ , input slew rate =  $1 \text{ V/ns} \pm 20\%$  (unless otherwise specified).

Test Circuits and Waveforms ( $V_{DD} = 1.8V \pm 0.1V$ )

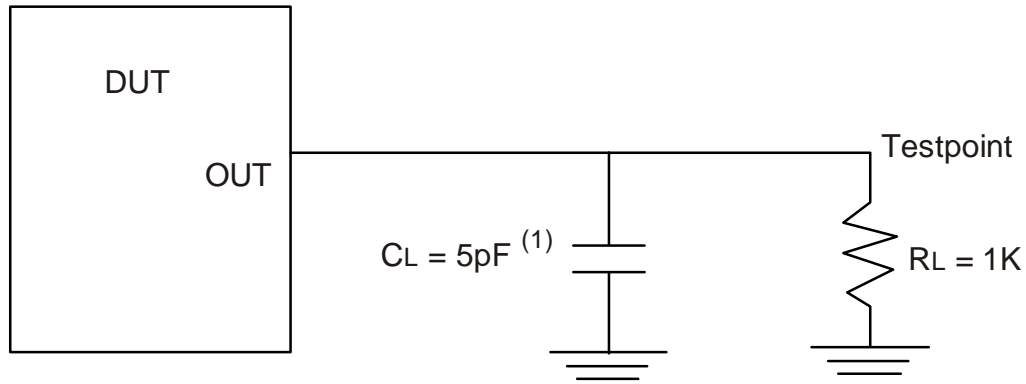

Partial Parity Out Load Circuit

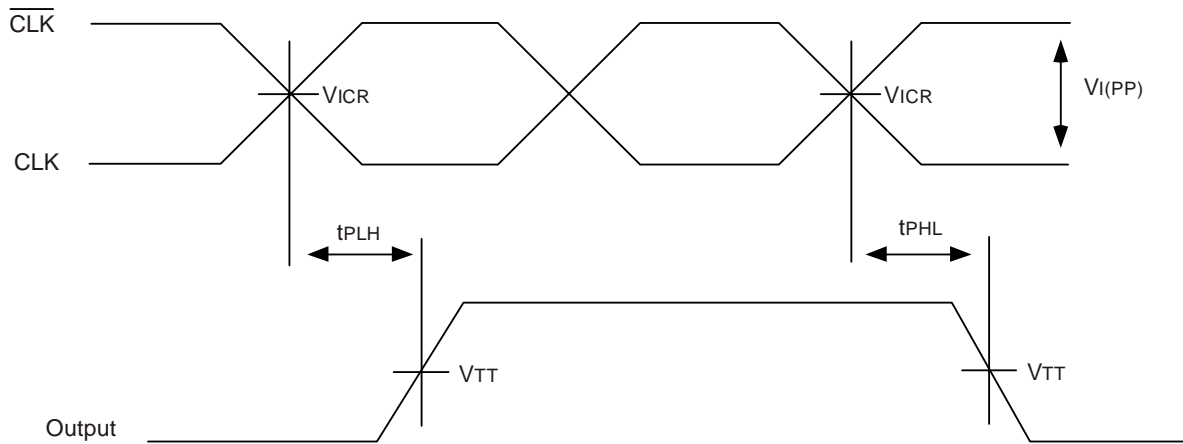

Partial Parity Out Voltage Waveform, Propagation Delay Time with Respect to CLK Input

$V_{TT} = V_{DD}/2$

VICR Cross Point Voltage

$V_{I(PP)} = 600mV$

tPLH and tPHL are the same as tPD.

### Ordering Information

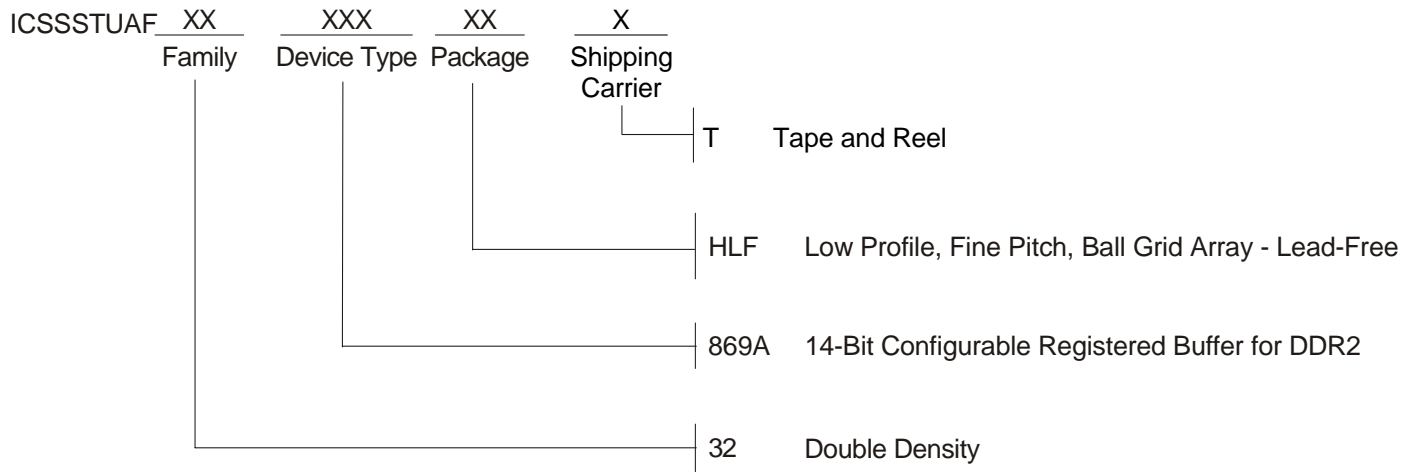

Innovate with IDT and accelerate your future networks. Contact:

**www.IDT.com**

**For Sales**

800-345-7015  
408-284-8200  
Fax: 408-284-2775

---

**Corporate Headquarters**

Integrated Device Technology, Inc.  
6024 Silver Creek Valley Road  
San Jose, CA 95138  
United States  
800 345 7015  
+408 284 8200 (outside U.S.)

**Asia Pacific and Japan**

Integrated Device Technology  
Singapore (1997) Pte. Ltd.  
Reg. No. 199707558G  
435 Orchard Road  
#20-03 Wisma Atria  
Singapore 238877  
+65 6 887 5505

**Europe**

IDT Europe, Limited  
Prime House  
Barnett Wood Lane  
Leatherhead, Surrey  
United Kingdom KT22 7DE  
+44 1372 363 339



www.IDT.com