

UMCC – Ultraminiature Coax Connector & Cable Assembly Series

DESCRIPTION

Tyco Electronics introduces the Ultraminiature Coax Connector and Cable Assembly series products. The UMCC series is an ultra low profile coax interconnect solution that meets the ever growing demand for miniaturization in next generation wireless applications. UMCC cable assemblies and connectors are available as double-ended jumpers and inter-series assemblies, and PCB jack receptacles for board mount applications.

Tyco Electronics specializes in solving tough problems with cable assemblies designed and manufactured to meet the most demanding requirements. Tyco Electronics can engineer custom UMCC solutions to meet special requirements. By making Tyco Electronics your partner in cable assembly design, you reduce risk and gain assurance that you will receive your assembly on time, to specification and within budget.

APPLICATIONS

- Wireless LAN, Mini PCI
- Mobile Antenna/GPS/Radio Systems
- PDA / PCS / Cellular Handset applications
- Wireless Communications systems (LAN, GSM, PCS, WCDMA, UMTS)
- Remote measuring equipment

KEY FEATURES

- Ultra low profile (2.0mm Type II or 2.5mm Type III maximum mated height)
- Easy snap on/off mating
- Small footprint on PCB (3mm x 3mm)
- Excellent performance to 6 GHz
- Surface mount and reflow solderable
- 360 degree mated rotation
- Available on 0.81mm, 1.13mm, and 1.37mm dia single shield, and 1.32mm dia double shield cable
- Compatible with Hirose U.FL/U.FL(v) Series connectors

For More Information

Technical Support

Internet:

<http://tycoelectronics.com/products/rfcoax>

Email:

product.info@tycoelectronics.com

US Product Manager Cable Assemblies — David Stonfer

Phone: 717-986-5950

Email: david.stonfer@tycoelectronics.com

Global Product Manager Connectors — Claude de Lorraine

Phone: 717-986-5793

Email: cdeLorraine@tycoelectronics.com

Europe Product Manager — Rob Smeets

Phone: +31-736246327

Email: r.smeets@tycoelectronics.com

USA: 1-800-522-6752

Canada: 1-905-470-4425

Mexico: 01-800-733-8926

C. America: 52-55-1106-0803

South America: 55-112103-6000

Hong Kong: 852-2735-1628

Japan: 81-44-844-8013

UK: 31 73 6246 431

SPECIFICATIONS

ELECTRICAL

| | |
|---------------------------------------|---|
| Characteristic Impedance: | 50 Ohms |
| Frequency Range: | DC to 6 GHz |
| VSWR (mated pair): | 1.30 max DC to 3 GHz 1.5 max 3 to 6 GHz (typical) |
| Insertion Loss (connectors only): | 0.24 dB max DC to 6 GHz |
| Rated voltage: | 60 VAC (rms) – standard recept |
| Dielectric Withstanding Voltage: | 200 VAC, 50 Hz for 1 min (at sea level) |
| Insulation Resistance: | 500 Megohms min |
| Contact Resistance (connectors only): | 20 milliohms max (Center) 10 milliohms max (Outer, Plug) 10 milliohms max (Outer, Receptacle) |

MECHANICAL / ENVIRONMENTAL

| | |
|-----------------------------------|---|
| Durability: | 30 cycles – standard recept |
| Disengagement Force: | 2N min perpendicular 4N min orthogonal |
| Center Contact Retention force: | 0.15N min |
| Tape/Reel Packaging (receptacle): | 12mm carrier per EIA-481 |
| Operating Temperature: | - 40°C to + 90°C |

MATERIAL

| Part Description | Material | Finish |
|------------------------|----------------------|-------------------------|
| Shell | Phosphor Bronze | Gold or Silver Plating |
| Male Center Contact | Brass or Phos Bronze | Gold Plating |
| Female Center Contact | Brass or Phos Bronze | Gold Plating |
| Insulator (Plug) | PBT (15% G.F.) | Black, UL94V-0 |
| Insulator (Receptacle) | LCP | Beige or Black, UL94V-0 |

SPECIFICATIONS

| CABLE INFORMATION | | | | |
|--------------------------|--|--|--|--|
| | 0.81 mm Diameter | 1.13 mm Diameter | 1.32mm Diameter | 1.37mm Diameter |
| MATERIALS: | | | | |
| Center Conductor | Silver Plated Copper | Silver Plated Copper | Silver Plated Copper | Silver Plated Copper |
| Size | Stranded 7/0.05 mm | Stranded 7/0.08 mm | Stranded 7/0.08 mm | Stranded 7/0.10 mm |
| Dielectric | FEP or PFA | FEP | FEP | FEP |
| Size | 0.40 mm OD | 0.62 mm OD | 0.66 mm OD | 0.83 mm OD |
| Shield | Silver Plated Copper Braid | Silver Plated Copper Braid | Double SPL Braid | Silver Plated Copper Braid |
| Coverage | > 90% | > 90% | > 90% | > 90% |
| Jacket | FEP or PFA | FEP | > 90% | > 90% |
| Size | 0.81 mm OD | 1.13 mm OD | 1.32 mm OD | 1.37 mm OD |
| MECHANICAL: | | | | |
| Minimum Bend Radius | 5 mm Single Bend 30 mm Continuous Flexing | 5 mm Single Bend 30 mm Continuous Flexing | 5 mm Single Bend 30 mm Continuous Flexing | 5 mm Single Bend 30 mm Continuous Flexing |
| ELECTRICAL: | | | | |
| Impedance (Ohms) | 50±2 | 50±2 | 50±2 | 50±2 |
| Velocity of Propagation | 70% | 70% | 70% | 70% |
| CC Resistance (Ohms/M) | 1.450 | 0.750 | 0.560 | 0.354 |
| Voltage Rating | 60 VAC | 60 VAC | 60 VAC | 60 VAC |
| Attenuation | See Chart | See Chart | See Chart | See Chart |

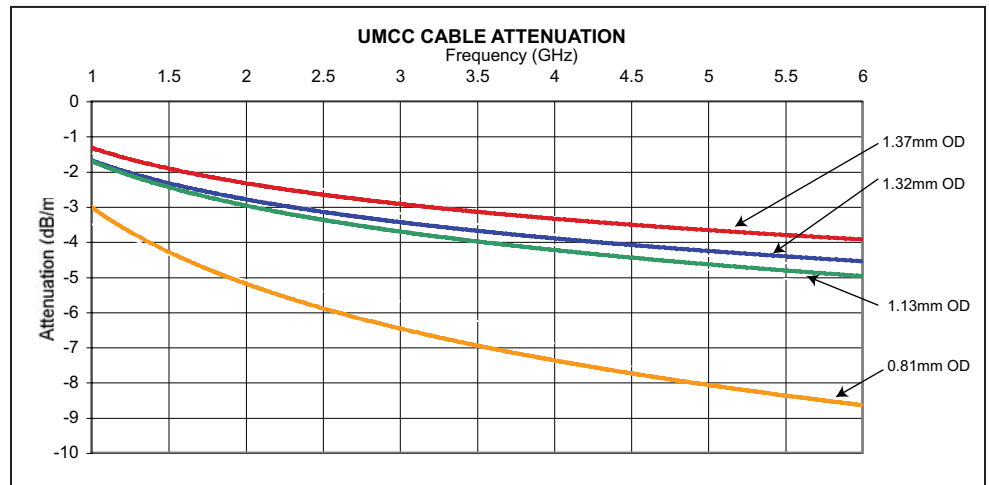
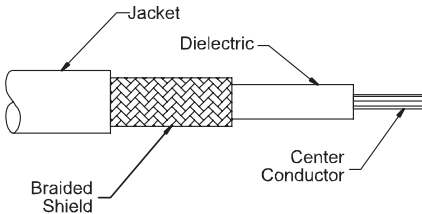

Dimensions are millimeters [inches] unless otherwise specified.

Standard Double Ended Cable Assemblies

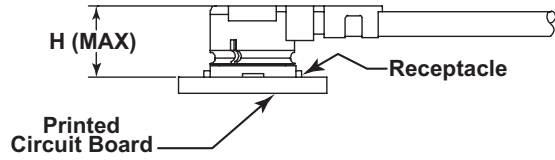

| Part Number | Cable Dia | Length L | UMCC Cable Connector Type | Mated Height (H) |
|-------------|-----------|----------|---------------------------|------------------|
| 2015698-4 | 0.81mm | 50mm | II | 2.0mm |
| 2015698-2 | 0.81mm | 100mm | II | 2.0mm |
| 2015698-3 | 0.81mm | 200mm | II | 2.0mm |
| 2015699-3 | 0.81mm | 50mm | III | 2.5mm |
| 2015699-1 | 0.81mm | 100mm | III | 2.5mm |
| 2015699-2 | 0.81mm | 200mm | III | 2.5mm |
| 2015487-6 | 1.13mm | 50mm | III | 2.5mm |
| 2015487-4 | 1.13mm | 100mm | III | 2.5mm |
| 2015487-5 | 1.13mm | 200mm | III | 2.5mm |
| 2015700-3 | 1.32mm | 50mm | III | 2.5mm |
| 2015700-1 | 1.32mm | 100mm | III | 2.5mm |
| 2015700-2 | 1.32mm | 200mm | III | 2.5mm |
| 2015357-2 | 1.37mm | 50mm | III | 2.5mm |
| 2015357-3 | 1.37mm | 100mm | III | 2.5mm |
| 2015357-4 | 1.37mm | 200mm | III | 2.5mm |

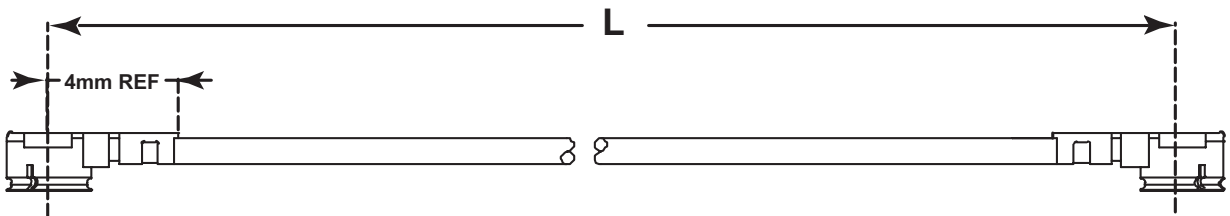

| Total Length (mm) | Standard Tolerance (mm) |
|-------------------|-------------------------|
| 25 < L < 200 | +/- 2 |
| 200 < L < 700 | +/- 3 |
| 700 < L < 900 | +/- 4 |
| 900 < L | +/- 5 |

Note: Shortest length L is 25mm

Custom cable assembly lengths available. Contact Tyco Electronics with specific requirements.

Interseries Cable Assemblies



| Part Number | Description | Cable Dia | UMCC Conn Type | Mated Height (H) |
|-------------|--------------------------|-----------|----------------|------------------|
| 2032439-1 | UMCC to STD SMA Plug | 1.37mm | III | 2.5mm |
| 2032440-1 | UMCC to STD SMA BHD Jack | 1.37mm | III | 2.5mm |
| 2032445-1 | UMCC to R/P SMA BHD Jack | 1.13mm | III | 2.5mm |
| 2032446-1 | UMCC to R/P TNC BHD Jack | 1.13mm | III | 2.5mm |
| 2032407-2 | UMCC to STD TNC BHD Jack | 1.13mm | III | 2.5mm |
| 2032441-1 | UMCC to MCX R/A Plug | 0.81mm | II | 2.0mm |
| 2032442-1 | UMCC to MCX R/A Plug | 1.37mm | III | 2.5mm |
| 2032443-1 | UMCC to MMCX R/A Plug | 0.81mm | II | 2.0mm |
| 2032444-1 | UMCC TO MMCX R/A Plug | 1.37mm | III | 2.5mm |

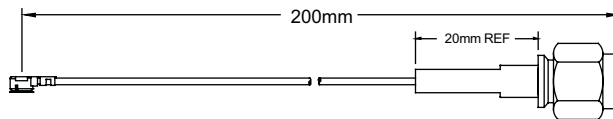

UMCC to SMA Plug

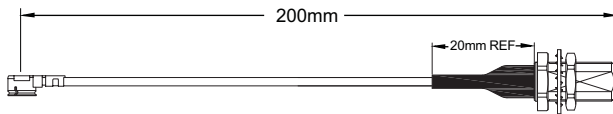

UMCC to SMA Bulkhead Jack

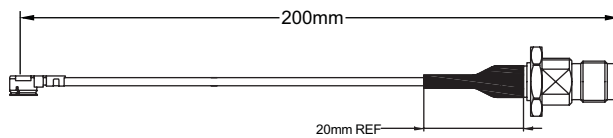

UMCC to TNC

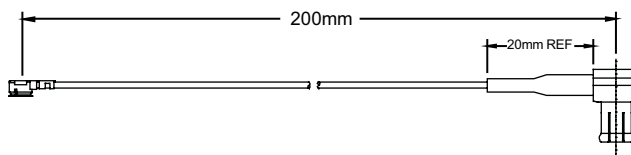

UMCC to MCX R/A Plug

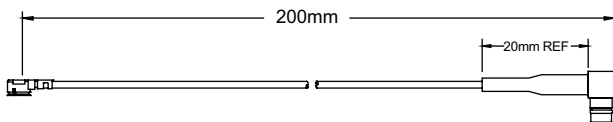

UMCC to MMCX R/A Plug

Standard length is 200mm.
Custom cable assembly lengths and connector configurations are available.
Contact Tyco Electronics with specific requirements.

Adapters

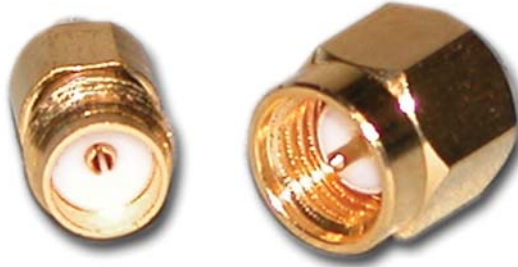

| Part Number | Description | UMCC Conn Type |
|-------------|----------------------------------|----------------|
| 1775230-1 | UMCC Plug to SMA Jack | II/III |
| 1775227-1 | UMCC Jack Receptacle to SMA Plug | II/III |

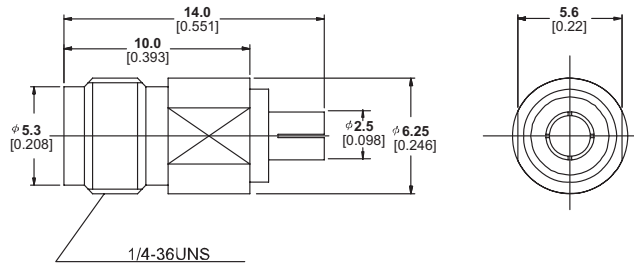

Part Number 1775230

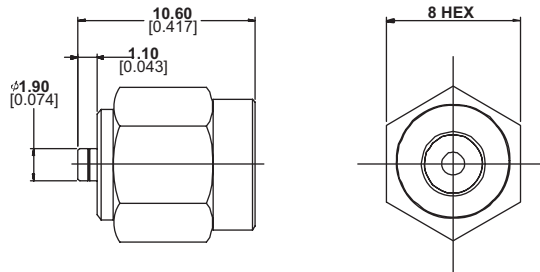

Part Number 1775227

Dimensions are millimeters [inches] unless otherwise specified

PCB Receptacles

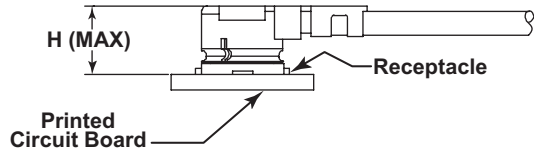

| Part Number | Description | Mates with UMCC Cable Conn Type | Mated Height (H) | Packaging |
|-------------|---------------------|---------------------------------|------------------|-------------------------|
| 1566230-1 | UMCC PCB Receptacle | II/III | 2.0mm/2.5mm | Tape (2500 pieces/reel) |
| 1566230-2 | UMCC PCB Receptacle | II/III | 2.0mm/2.5mm | Bulk (500 pieces/bag) |

UMCC PCB Receptacle

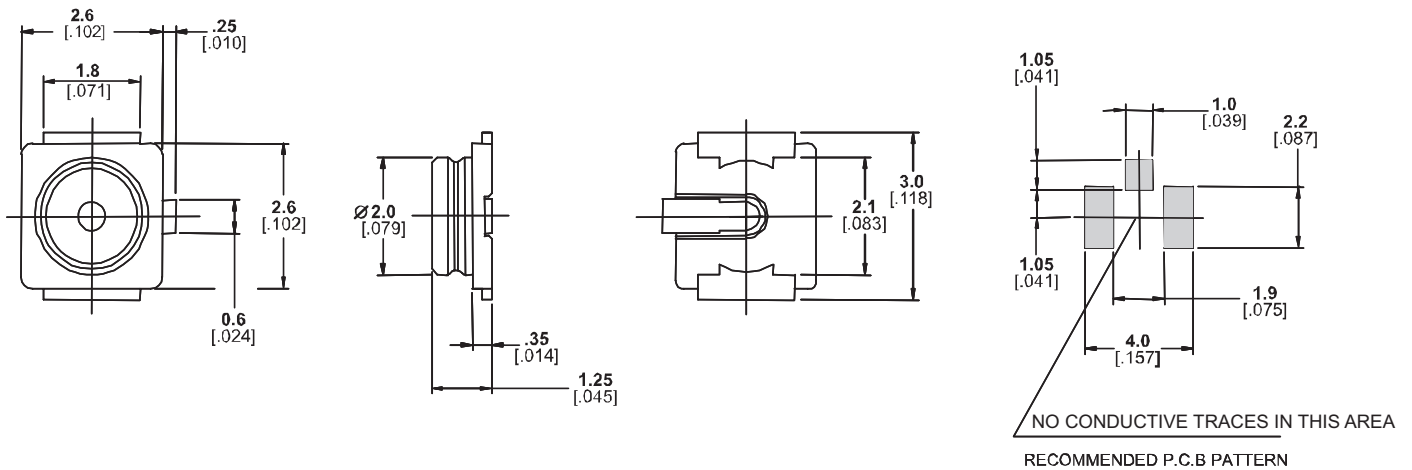

Dimensions are millimeters [inches] unless otherwise specified

Application Notes

Soldering Profile - SMT Receptacle

Recommended Temperature Profile (Reference)

- 1) The preferred technique for mounting the SMT Receptacle package is to reflow solder the device onto a PCB (Printed Circuit Board).
- 2) The maximum temperature for the lead of PCB surface does not exceed 240 .
- 3) The right reflow soldering profile is for reference and will modify under individual different conditions.

Hand Soldering (Reference only)

- 1) Soldering iron: The maximum temperature 240 .
- 2) Soldering period: within 5 seconds.

RECOMMENDED TEMPERATURE PROFILE (REFERENCE)

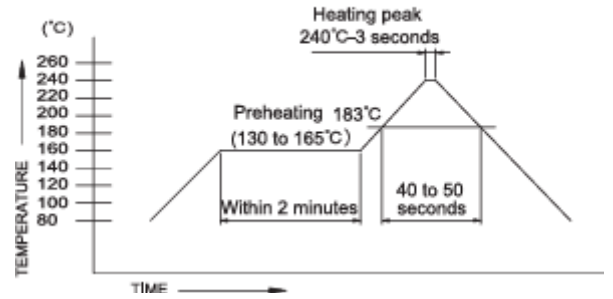

Tape and Reel Packaging Specifications

Standard Receptacles

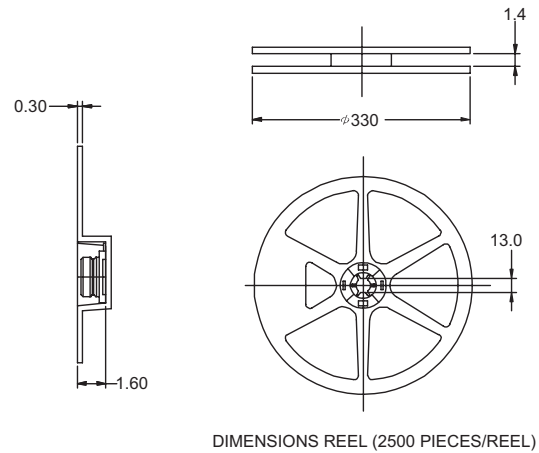
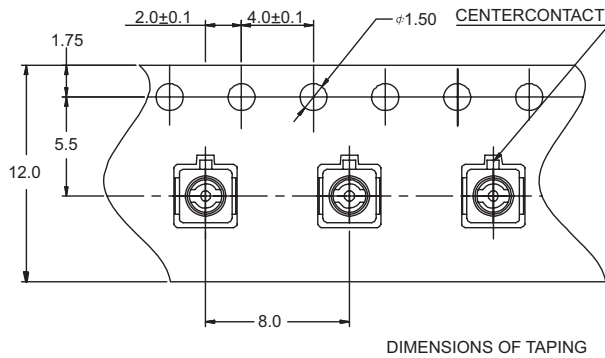

Application Notes

Extraction Tool

Part Number: 1775231-1

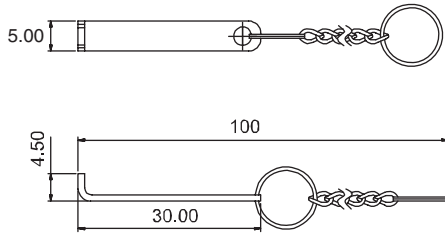

Mating/Unmaking — Cable Plugs

- 1) To mate the connectors, insert the cable plug into the SMT receptacle, making sure the cable plug is as vertical as possible and the mating axis of both connectors are aligned. Do not insert on an extreme angle.
- 2) To unmate the connectors, insert the end portion of the extraction tool under the SMT receptacle connector flanges and pull off vertically in the direction of the mating axis.

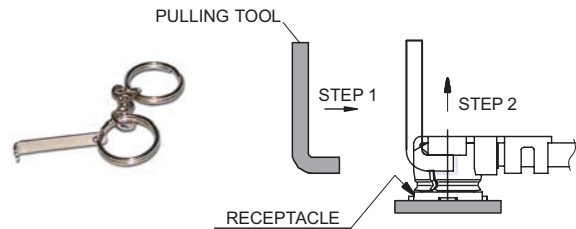

Permissible Load

Do not apply excessive load to the cable after the connectors are mated. Please refer to the permissible loads indicated in the figure to the right.

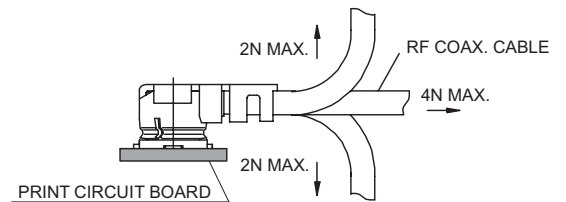

Disclaimer

While Tyco Electronics Corporation and its affiliates referenced herein (“Tyco Electronics”) have made every reasonable effort to ensure the accuracy of the information in this catalog, Tyco Electronics does not guarantee that it is error free, nor does Tyco Electronics make any other representation, warranty or guarantee that the information is accurate, correct reliable or current.

Tyco Electronics reserves the right to make any adjustments to the information contained herein at any time without notice.

Tyco Electronics expressly disclaims all implied warranties regarding the information contained herein, including, but not limited to, any implied warranties of merchantability or fitness for a particular purpose. Tyco Electronics' only obligations are those in the Tyco Electronics Standard Terms and Conditions of Sale, and in no case will Tyco Electronics be responsible for any incidental, indirect, or consequential damages arising from the sale, resale, or misuse of its products. Users should independently evaluate the suitability of, and test each product for, their application

Copyright 2008 by Tyco Electronics Corporation. All Rights Reserved.

TE LOGO and TYCO ELECTRONICS are trademarks.

HIROSE is a trademark of Hirose Electric U.S.A. Hirose Electric U.S.A. is not affiliated with the UMCC product.

Other products, logos, and Company names mentioned herein maybe trademarks of their respective owners.

1-1773441-5_08/08_CCCE_PDF