

## AVO240-48S12

240 Watts

Eighth-brick Converter

**Total Power:** 240 Watts  
**Input Voltage:** 41 to 75 Vdc  
**# of Outputs:** Single

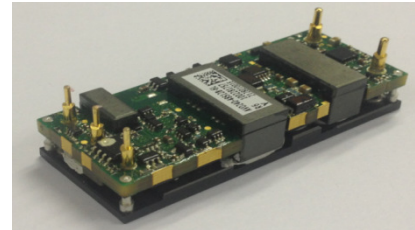
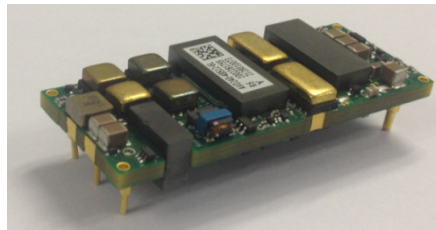

### Special Features

- Delivering up to 20A output
- Ultra-high efficiency 94% typ. at full load
- Wide input range: 41V ~ 75V
- Excellent thermal performance
- No minimum load requirement
- Fixed frequency operation
- RoHS 6 compliant
- Remote control function
- Input under voltage lockout
- Output over current protection
- Output over voltage protection
- Over temperature protection
- Industry standard eighth-brick
- Open frame or baseplate optional
- Pin length option: 3.8mm

### Safety

IEC/EN 60950-1  
UL/TUV  
CE Marking  
GB4943  
EN55022 Class A

### Product Descriptions

The AVO240-48S12 series is a single output DC/DC converter with standard eighth-brick form factor and pin configuration. It delivers up to 20A output current with 12V output. Ultra-high 94% efficiency and excellent thermal performance makes it an ideal choice for use in computing and telecommunication applications and can operate over an ambient temperature range of -40 °C ~ +85 °C.

### Applications

Telecom/ Datacom

## Model Numbers

Standard	Output Voltage	Structure	Remote ON/OFF logic	RoHS Status
AVO240-48S12-6L	12Vdc	Open-frame	Negative	R6
AVO240-48S12P-6L	12Vdc	Open-frame	Positive	R6
AVO240-48S12B-6L	12Vdc	Baseplate	Negative	R6
AVO240-48S12PB-6L	12Vdc	Baseplate	Positive	R6

## Ordering information

AVO240	-	48	S	12	P	B	-	6	L
①		②	③	④	⑤	⑥		⑦	⑧

①	Model series	AVO: series name, 240: rated output power 240W
②	Input voltage	48: 41V ~ 75V input range, rated input voltage 48V
③	Output number	S: single output
④	Rated output voltage	12: 12V output
⑤	Remote ON/OFF logic	Default: negative logic; P: positive logic
⑥	Baseplate	Default: without baseplate; B:with baseplate
⑦	Pin length	6: 3.8mm
⑧	RoHS status	L: RoHS, R6; Y: RoHS, R5

## Options

None

## Electrical Specifications

### Absolute Maximum Ratings

Stress in excess of those listed in the “Absolute Maximum Ratings” may cause permanent damage to the power supply. These are stress ratings only and functional operation of the unit is not implied at these or any other conditions above those given in the operational sections of this TRN. Exposure to any absolute maximum rated condition for extended periods may adversely affect the power supply’s reliability.

Table 1. Absolute Maximum Ratings:

Parameter	Model	Symbol	Min	Typ	Max	Unit
Input Voltage	Operating -Continuous	All	-	-	80	Vdc
	Non-operating -100mS	All	-	-	100	Vdc
Maximum Output Power	All	$P_{O,max}$	-	-	240	W
Isolation Voltage <sup>1</sup>	Input to outputs	Open frame modules	-	-	1500	Vdc
		Baseplate modules	-	-	1500	Vdc
Ambient Operating Temperature	All	$T_A$	-40	-	+85	°C
Storage Temperature	All	$T_{STG}$	-55	-	+125	°C
Voltage at remote ON/OFF input pin	All		-0.7	-	5	Vdc
Humidity (non-condensing)	Operating	All	-	-	95	%
	Non-operating	All	-	-	95	%

Note 1 - 1mA for 60s, slew rate of 1500V/10s.

## Input Specifications

Table 2. Input Specifications:

Parameter	Conditions	Symbol	Min	Typ	Max	Unit
Operating Input Voltage, DC	All	$V_{IN,DC}$	41	48	75	Vdc
Turn-on Voltage Threshold	$I_O = I_{O,max}$	$V_{IN,ON}$	31	-	36	Vdc
Turn-off Voltage Threshold	$I_O = I_{O,max}$	$V_{IN,OFF}$	30	-	35	Vdc
Lockout Voltage Hysteresis	$I_O = I_{O,max}$		1	-	3	Vdc
Maximum Input Current ( $I_O = I_{O,max}$ )	$V_{IN,DC} = 41V_{DC}$	$I_{IN,max}$	-	-	6.7	A
Recommended Input Fuse	Fast blow external fuse recommended		-	-	15	A
Input filter component values (C\L)	Internal values		-	5.4\2.2	-	$\mu F\mu H$
Recommended External Input Capacitance	Low ESR capacitor recommended	$C_{IN}$	220	-	-	$\mu F$
Input Reflected Ripple Current	Through 12 $\mu H$ inductor		-	45	-	mA
Operating Efficiency	$T_A = 25^\circ C$ $I_O = I_{O,max}$ $I_O = 50\% I_{O,max}$ $I_O = 20\% I_{O,max}$	$\eta$	-	94 94.3 91	-	%

## Output Specifications

Table 3. Output Specifications:

Parameter	Condition	Symbol	Min	Typ	Max	Unit	
Factory Set Voltage	$V_{IN,DC} = 48V_{DC}$ $I_O = I_{O,max}$	$V_O$	11.6	11.9	12.2	Vdc	
Total output voltage range <sup>1</sup>	All	$V_O$	11.2	11.9	12.5	Vdc	
Output Voltage Line Regulation	All	$\%V_O$	-	0.1	0.3	%	
Output Voltage Load Regulation	All	$\%V_O$	-	0.1	0.5	%	
Output Voltage Temperature Regulation	All	$\%V_O$	-	-	0.02	$\%/^{\circ}C$	
Output Ripple, pk-pk	Measure with a 1uF ceramic capacitor in parallel with a 10uF tantalum capacitor, 0 to 20MHz bandwidth	$V_O$	-	70	-	mV <sub>PK-PK</sub>	
Operating Output Current Range	All	$I_O$	0	-	20	A	
Output DC current-limit inception <sup>2</sup>	All	$I_O$	21.5	-	43	A	
Output Capacitance <sup>3</sup>	All	$C_O$	100	1000	5000	uF	
$V_O$ Dynamic Response	25% ~ 50% ~ 25% $I_{O,max}$ load change slew rate = 0.1A/us	$\pm V_O$ $T_s$	- -	200 200	- -	mV uSec	
Turn-on transient	Rise time	$I_O = I_{max}$	$T_{rise}$	-	-	50	mS
	Turn-on delay time	$I_O = I_{max}$	$T_{turn-on}$	-	-	100	mS
	Output voltage overshoot	$I_O = 0$	$\%V_O$	-	0	-	%
Switching frequency	All	$f_{SW}$	-	150	-	KHz	
Remote ON/OFF control (positive logic)	Off-state voltage	All	-0.7	-	1.2	V	
	On-state voltage	All	3.5	-	5	V	
Remote ON/OFF control (Negative logic)	Off-state voltage	All	3.5	-	5	V	
	On-state voltage	All	-0.7	-	1.2	V	

Note 1 - At  $V_{in} = 36V$  to  $41V$   $V_o$  is the lower limit 10.5 V

Note 2 - Hiccup: auto-restart when over-current condition is removed.

Note 3 - High frequency and low ESR is recommended.

## Output Specifications

Table 3. Output Specifications, con't:

Parameter	Condition	Symbol	Min	Typ	Max	Unit
Output over-voltage protection <sup>3</sup>	All	V <sub>O</sub>	13.5	-	18	Vdc
Output over-temperature protection <sup>4</sup>	All	T	110	124	135	°C
Over-temperature hysteresis Without baseplate	All	T	5	-	-	°C
MTBF	Telcordia SR-332-2006; 80% load, 300LFM, 40 °C T <sub>A</sub>		-	1.5	-	10 <sup>6</sup> h

Note 3 - Hiccup: auto-restart when over-voltage condition is removed.

Note 4 - Auto recovery.

## AVO240-48S12-6L Performance Curves

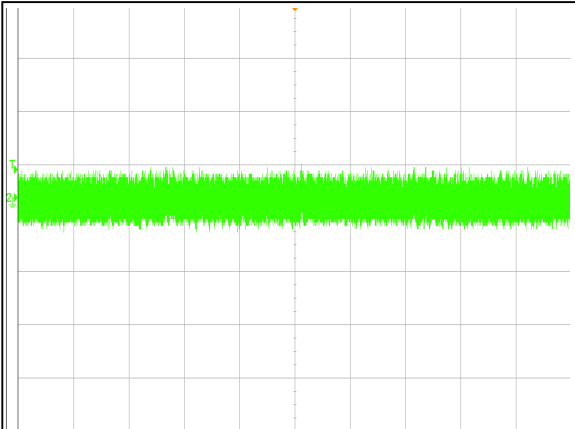

Figure 1: AVO240-48S12-6L Input Reflected Ripple Current Waveform  
Ch 1: Iin (2mS/div, 20mA/div)

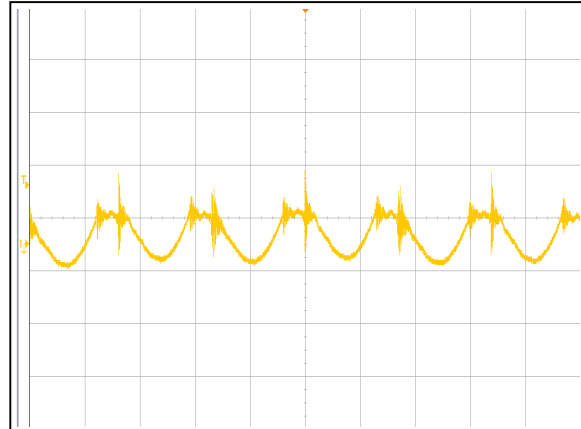

Figure 2: AVO240-48S12-6L Ripple and Noise Measurement  
Ch 1: Vo (2us/div, 20mV/div)

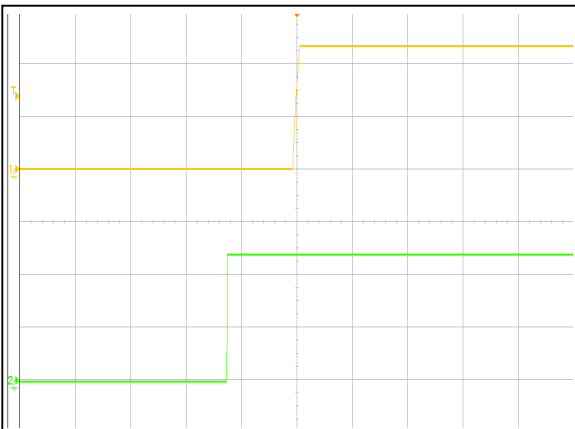

Figure 3: AVO240-48S12-6L Turn on Characteristic (50mS/div)  
Ch 1: Vo (5V/div) Ch 2: Vin (20V/div)

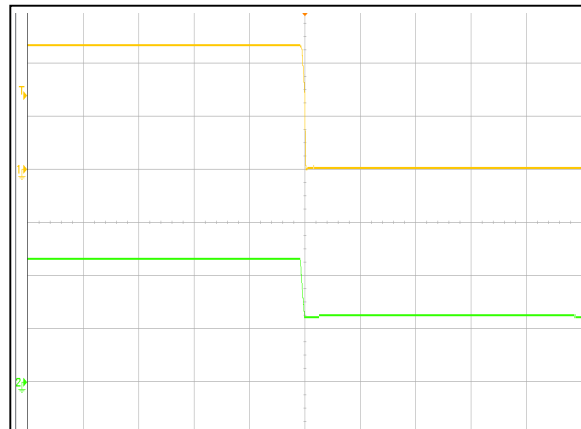

Figure 4: AVO240-48S12-6L Turn Off Characteristic (10mS/div)  
Ch 1: Vin (20V/div) Ch 2: Vo (5V/div)

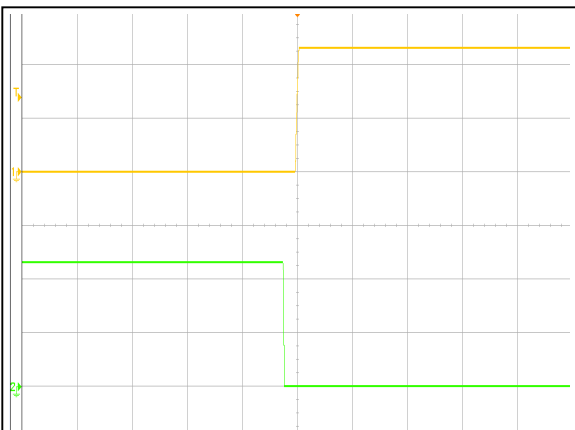

Figure 5: AVO240-48S12-6L Remote ON Waveform (100mS/div)  
Ch 1: Vo (5V/div) Ch 2: Remote ON (2V/div)

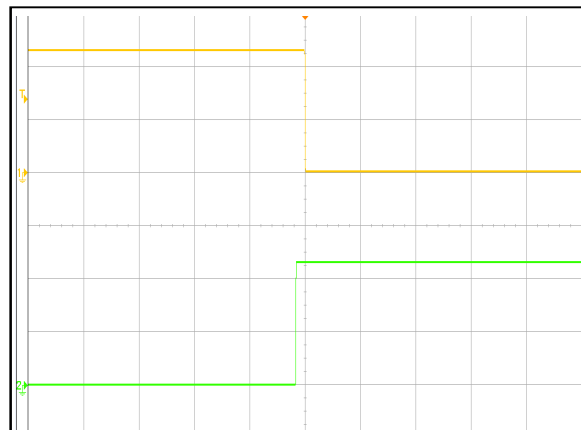

Figure 6: AVO240-48S12-6L Remote OFF Waveform (100mS/div)  
Ch 1: Vo (5V/div) Ch 2: Remote OFF (2V/div)

## AVO240-48S12-6L Performance Curves

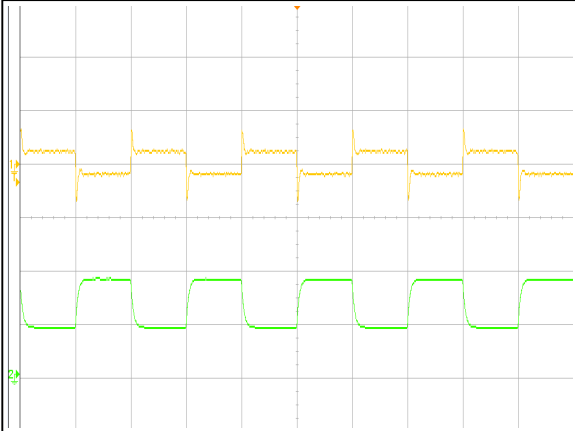

Figure 7: AVO240-48S12-6L Transient Response (2mS/div)  
 25%-50%~25% load change, 0.1A/uS slew rate,  
 Ch 1: Vo (50mV/div) Ch 2: Io (5A/div)

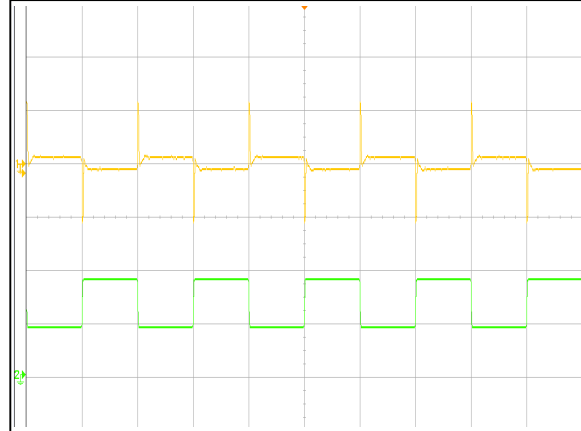

Figure 8: AVO240-48S12-6L Transient Response (2mS/div)  
 25%-50%~25% load change, 1A/uS slew rate,  
 Ch 1: Vo (100mV/div) Ch 2: Io (5A/div)

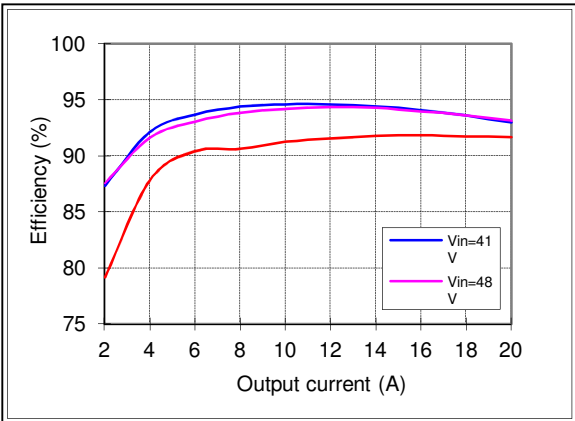

Figure 9: AVO240-48S12-6L Efficiency Curves  
 @ 25 degC, Vo = 12V  
 Loading: Io = 10% increment to 20A



## AVO240-48S12B-6L Performance Curves

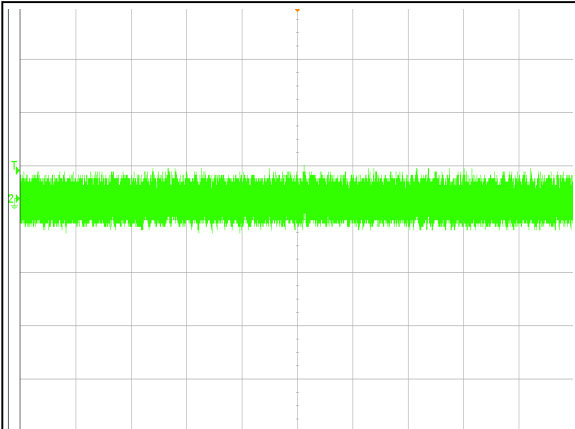

Figure 10: AVO240-48S12B-6L Input Reflected Ripple Current Waveform  
Ch 1: Iin (2mS/div, 20mA/div)

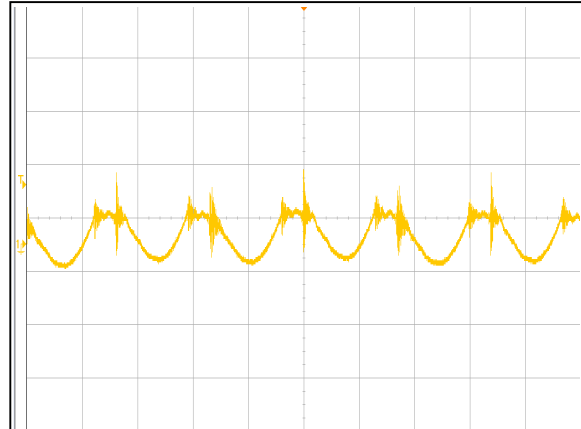

Figure 11: AVO240-48S12B-6L Ripple and Noise Measurement  
Ch 1: Vo (2us/div, 20mV/div)

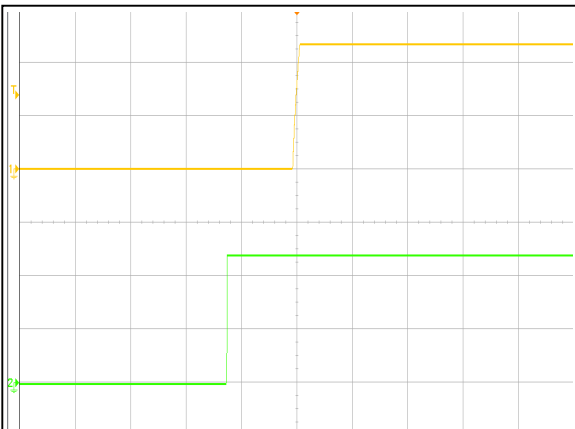

Figure 12: AVO240-48S12B-6L Turn on Characteristic (50mS/div)  
Ch 1: Vo (5V/div) Ch 2: Vin (20V/div)

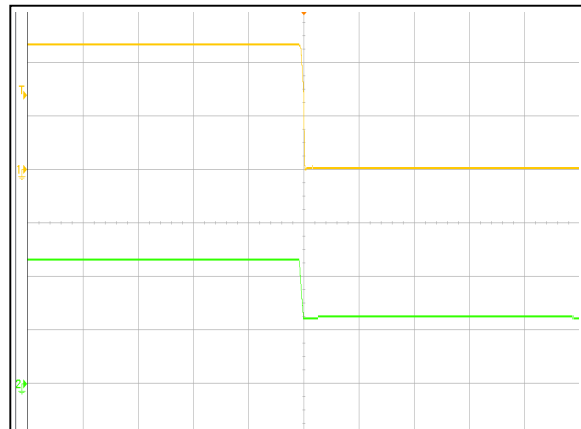

Figure 13: AVO240-48S12B-6L Turn Off Characteristic (10mS/div)  
Ch 1: Vin (20V/div) Ch 2: Vo (5V/div)

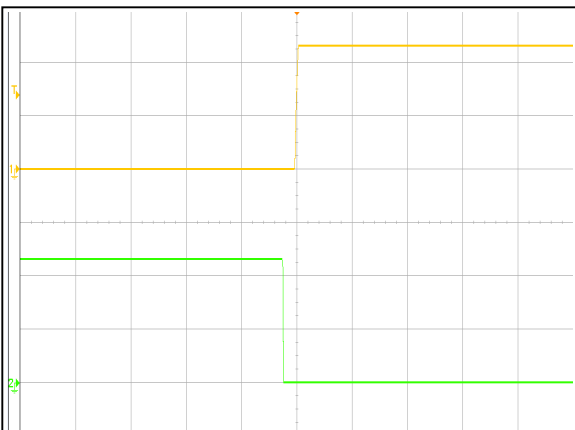

Figure 14: AVO240-48S12B-6L Remote ON Waveform (100mS/div)  
Ch 1: Vo (5V/div) Ch 2: Remote ON (2V/div)

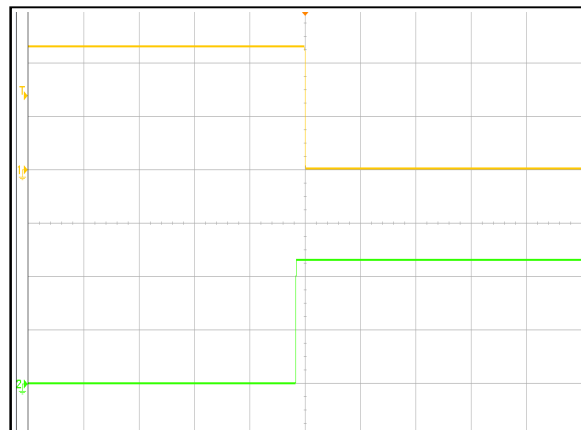

Figure 15: AVO240-48S12B-6L Remote OFF Waveform (20mS/div)  
Ch 1: Vo (5V/div) Ch 2: Remote OFF (2V/div)

## AVO240-48S12B-6L Performance Curves

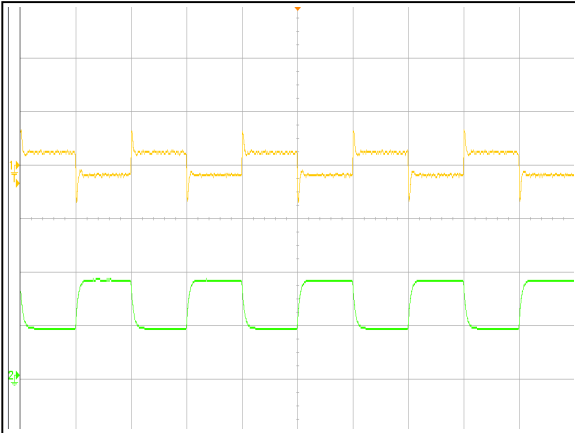

Figure 16: AVO240-48S12B-6L Transient Response (2mS/div)  
 25%~50%~25% load change, 0.1A/uS slew rate,  
 Ch 1: Vo (50mV/div) Ch 2: Io (5A/div)

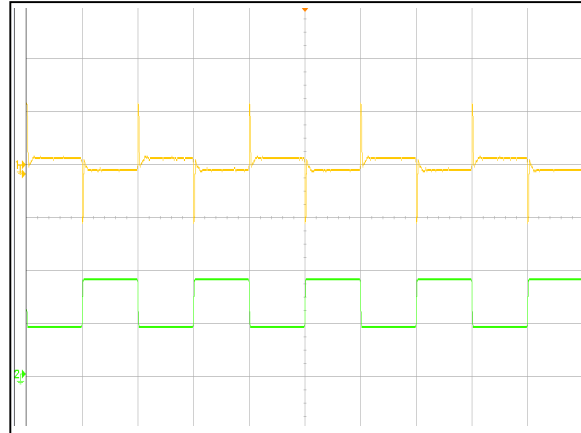

Figure 17: AVO240-48S12B-6L Transient Response (2mS/div)  
 25%~50%~25% load change, 1A/uS slew rate,  
 Ch 1: Vo (100mV/div) Ch 2: Io (5A/div)

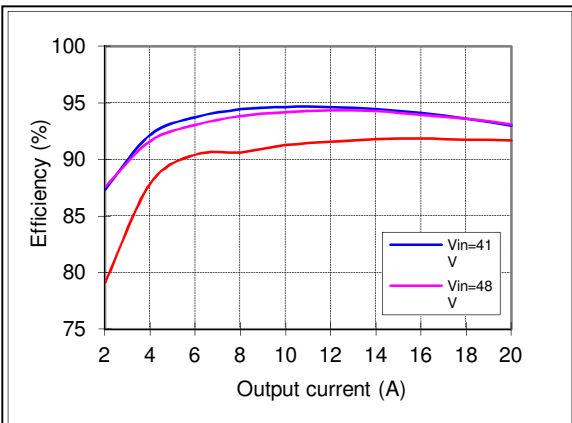
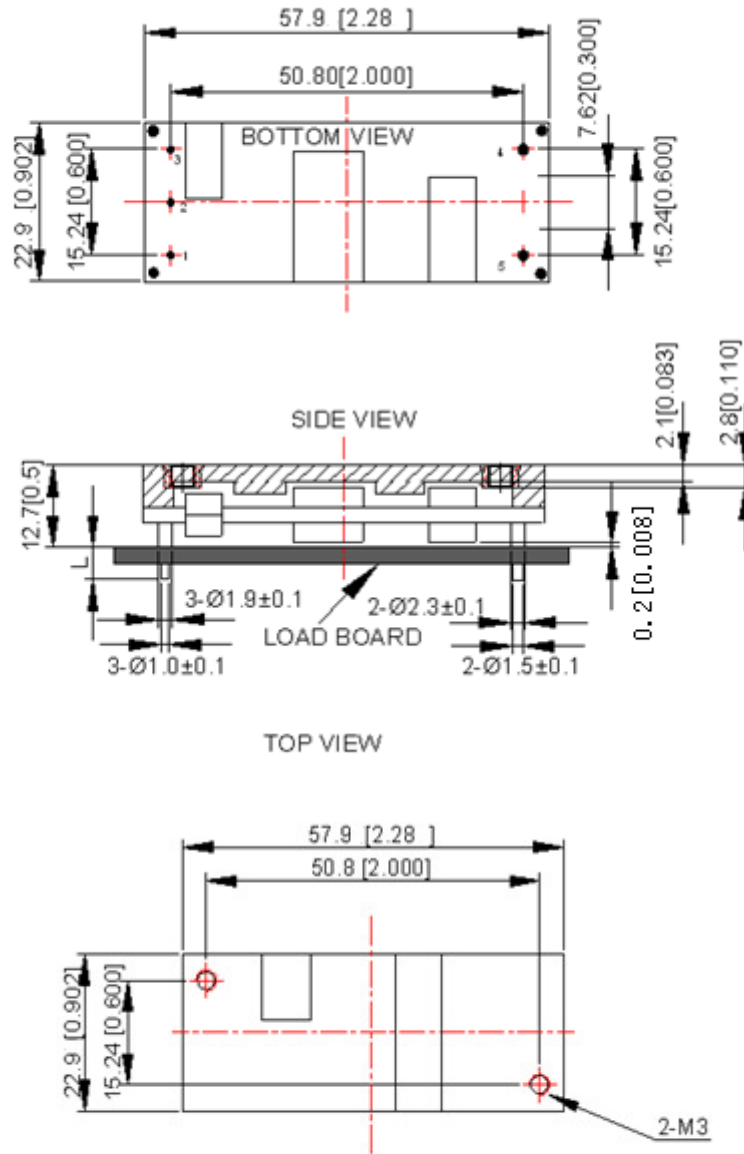

Figure 18: AVO240-48S12B-6L Efficiency Curves  
 @ 25 degC, Vo = 12V  
 Loading: Io = 10% increment to 20A

## Mechanical Specifications

### Mechanical Outlines – Base plate Module

AVO240-48S12



UNIT: mm[inch]      BOTTOM VIEW: pin on upside

TOLERANCE: X.Xmm $\pm$ 0.5mm[X.X in. $\pm$ 0.02in.]  
 X.XXmm $\pm$ 0.25mm[X.XX in. $\pm$ 0.01in.]

Figure 19 Mechanical diagram

**Mechanical Outlines – Open-Frame Module**

AVO240-48S12

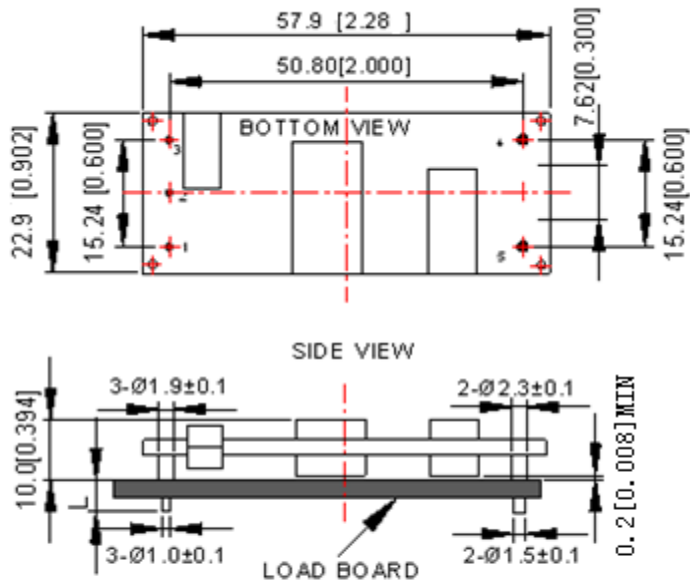

UNIT: mm[inch]                      BOTTOM VIEW: pin on upside  
TOLERANCE: X.Xmm±0.5mm[X.X in.±0.02in.]  
                  X.XXmm±0.25mm[X.XX in.±0.01in.]

## Pin Length Option

Device code suffix	L
-4	4.8mm ± 0.2 mm
-6	3.8mm ± 0.2 mm
-8	2.8mm ± 0.2 mm
None	5.8mm ± 0.2 mm

## Pin Designations

Pin No	Name	Function
1	Vin+	Positive input voltage
2	Remote On/Off	Remote control
3	Vin-	Negative input voltage
4	Vo-	Negative output voltage
5	Vo+	Positive output voltage

## Environmental Specifications

### EMC Immunity

AVO240-48S12 power supply is designed to meet the following EMC immunity specifications:

Table 4. Environmental Specifications:

Document	Description	Criteria
EN55022, Class A Limits	Conducted and Radiated EMI Limits	/
IEC/EN 61000-4-2, Level 3	Electromagnetic Compatibility (EMC) - Testing and measurement techniques - Electrostatic discharge immunity test. Enclosure Port	B
IEC/EN 61000-4-6, Level 2	Electromagnetic Compatibility (EMC) - Testing and measurement techniques, Continuous Conducted Interference. DC input port	A
IEC/EN 61000-4-4, Level3	Electromagnetic Compatibility (EMC) - Testing and measurement techniques, Electrical Fast Transient. DC input port.	B
IEC/EN 61000-4-5	Electromagnetic Compatibility (EMC) - Testing and measurement techniques, Immunity to surges - 600V common mode and 600V differential mode for DC ports	B
EN61000-4-29	Electromagnetic Compatibility (EMC) - Testing and measurement techniques, Voltage Dips and short interruptions and voltage variations. DC input port	B

Criterion A: Normal performance during and after test.

Criterion B: For EFT and surges, low-voltage protection or reset is not allowed. Temporary output voltage fluctuation ceases after disturbances ceases, and from which the EUT recovers its normal performance automatically. For Dips and ESD, output voltage fluctuation or reset is allowed during the test, but recovers to its normal performance automatically after the disturbance ceases. Criterion C: Temporary loss of output, the correction of which requires operator intervention. Criterion D: Loss of output which is not recoverable, owing to damage to hardware.

### Recommend EMC Filter Configuration

See figure 28

## Safety Certifications

The AVO240-48S12 power supply is intended for inclusion in other equipment and the installer must ensure that it is in compliance with all the requirements of the end application. This product is only for inclusion by professional installers within other equipment and must not be operated as a stand alone product.

Table 5. Safety Certifications for AVO240-48S12 series power supply system

Document	File #	Description
UL 60950		US Requirements
TUV 60950		Germany Requirements
EN60950		European Requirements
IEC60950		International Requirements
GB4943		China
CE		CE Marking

**Thermal Considerations – Open-frame module**

The converter is designed to operate in different thermal environments and sufficient cooling must be provided. Proper cooling of the DC/DC converter can be verified by measuring the temperature at the test points as shown in the Figure 21 and Figure 22. The temperature at this point should not exceed the max values in the table 1.

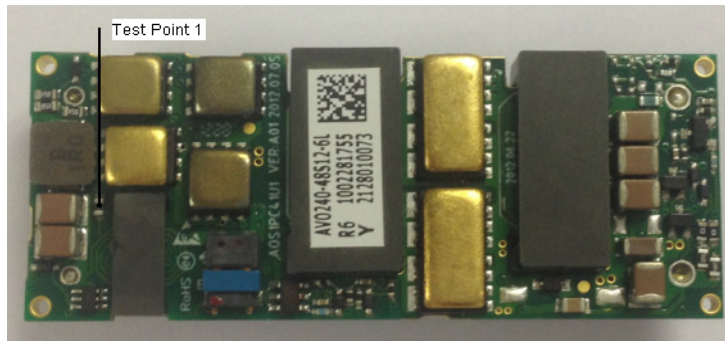

Figure 21 Thermal test points(TOP)

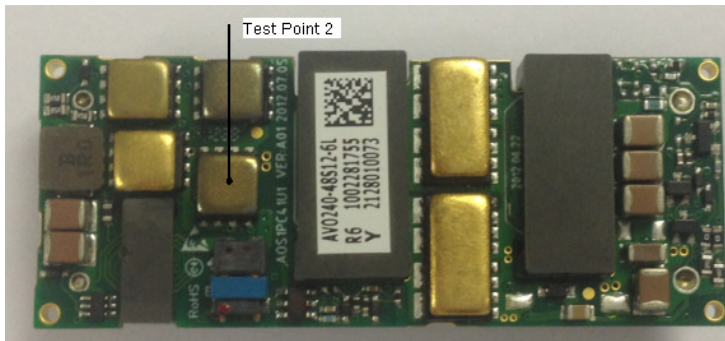

Figure 22 Thermal test points(TOP)

Table 6. Temperature limit of the test point

Test Point	Temperature Limit
Test point 1	120 °C
Test point 2	130 °C



**Thermal Considerations – Open-frame module**

For a typical application, forced airflow direction is from Vin- to Vin+, Figure 23 shows the derating output current vs ambient air temperature at different air velocity .

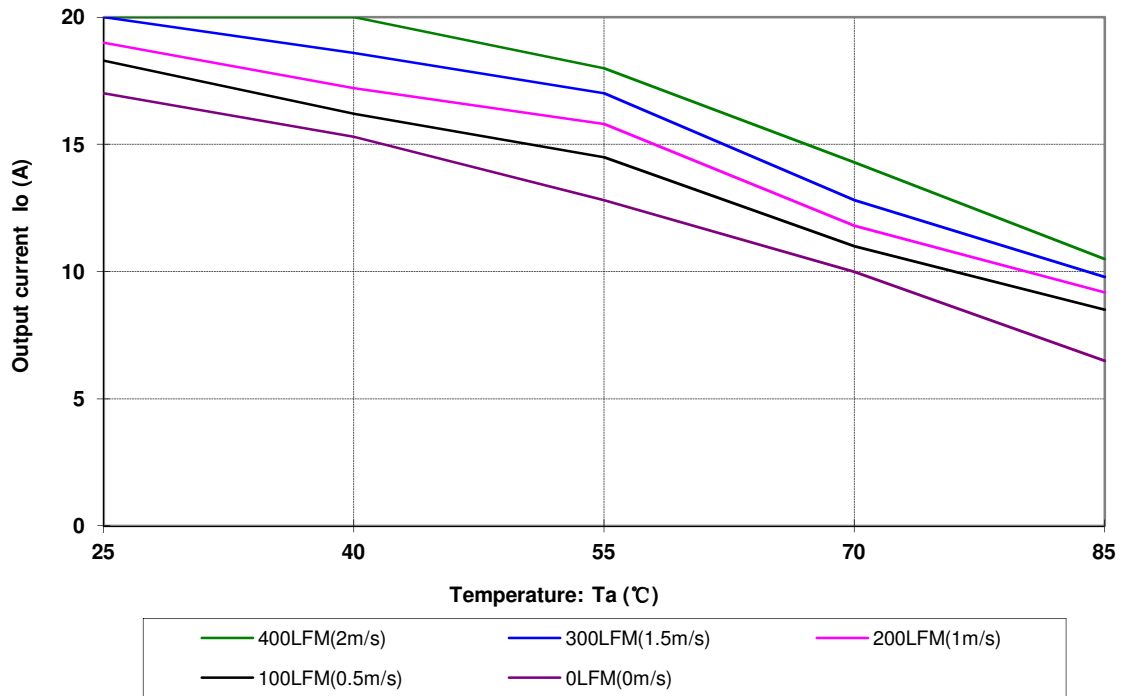

Figure 23 Output power derating,  $48V_{in}$ , air flowing across the converter from Vin- and Vin+

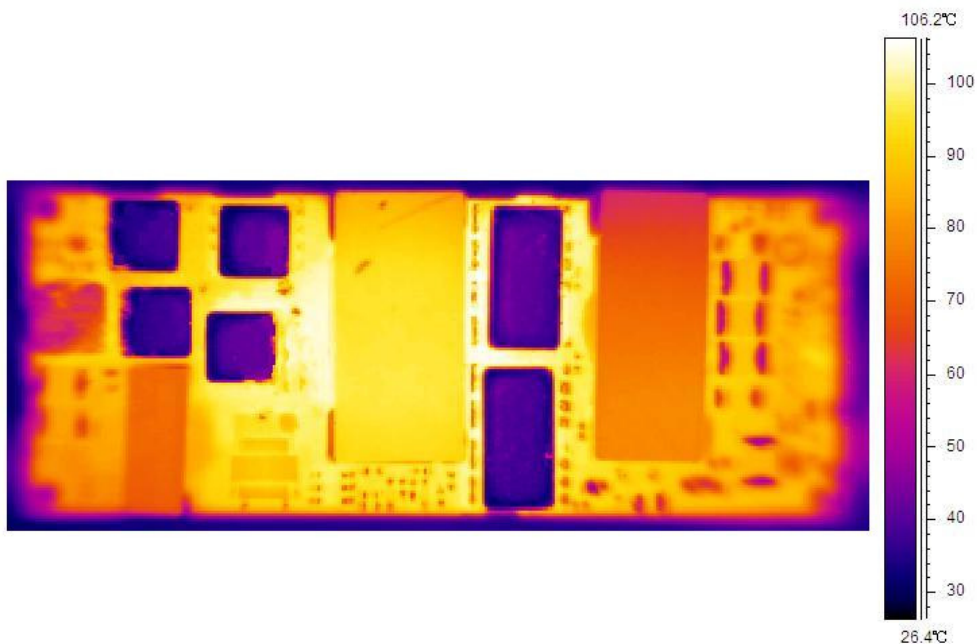

Figure 24 Infrared thermal image,  $48V_{in}$ @70%load, 200LFM, 25°C

**Thermal Considerations – Base plate module**

The converter is designed to operate in different thermal environments and sufficient cooling must be provided. Proper cooling of the DC/DC converter can be verified by measuring the temperature at the test point as shown in the Figure 25. The temperature at this point should not exceed the max values in the table 1.

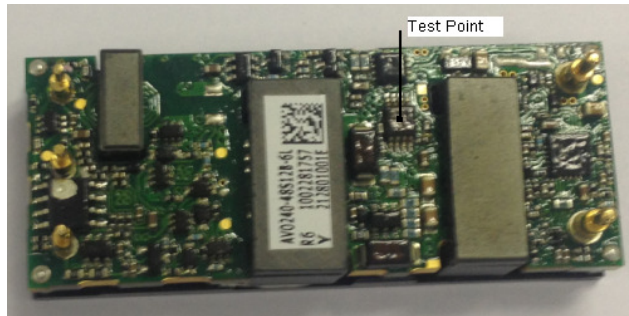

Figure 25 Thermal test point

Table 7. Temperature limit of the test point

Test Point	Temperature Limit
Test point	125 °C

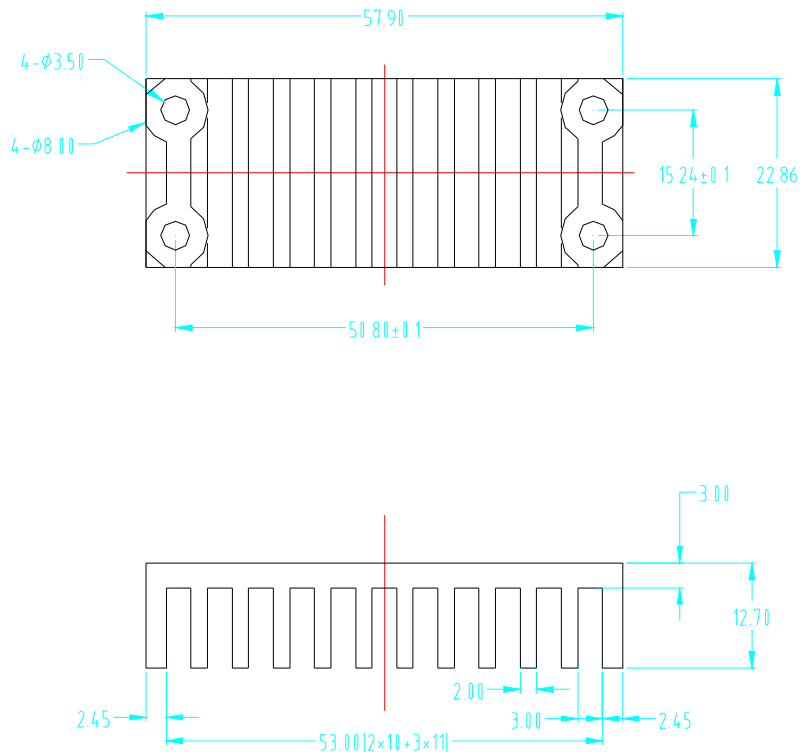

Figure 26 Heatsink

**Thermal Considerations – Base plate module**

For a typical application, forced airflow direction is from Vin- to Vin+, Figure 27 shows the derating output current vs ambient air temperature at different air velocity.

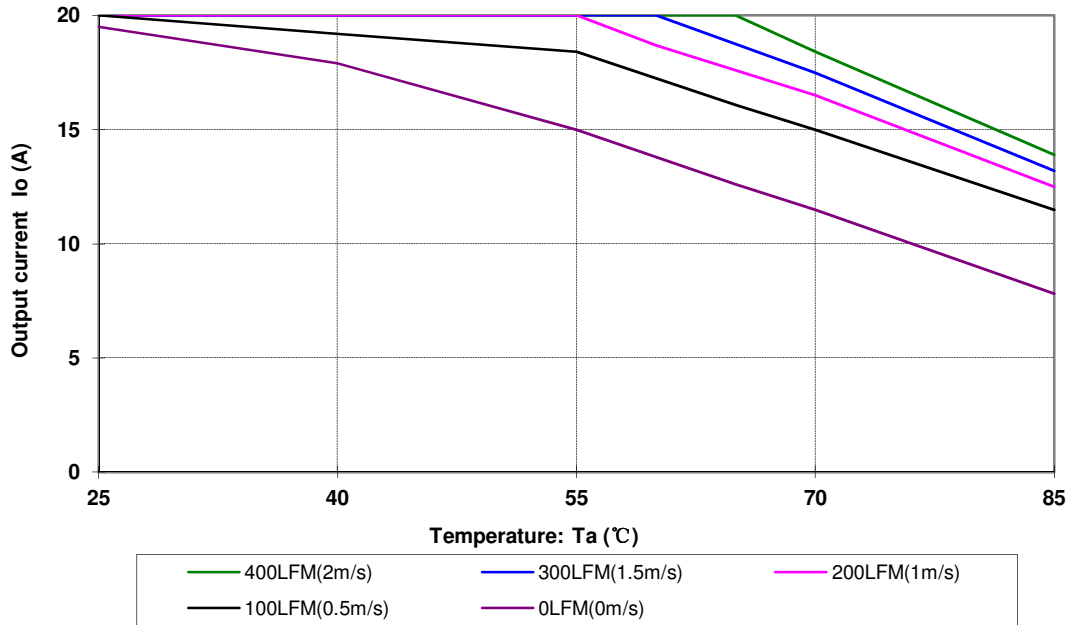

Figure 27 Output power derating, 48V<sub>in</sub>, air flowing across the converter from Vin- and Vin+

## Qualification Testing

Parameter	Unit (pcs)	Test condition
Halt test	4 ~ 5	$T_{a,min} - 10\text{ }^{\circ}\text{C}$ to $T_{a,max} + 10\text{ }^{\circ}\text{C}$ , $5\text{ }^{\circ}\text{C}$ step, $V_{in} = \text{min to max}$ , $0 \sim 105\%$ load
Vibration	3	Frequency range: 5Hz ~ 20Hz, 20Hz ~ 200Hz, A.S.D: /s <sup>3</sup> , -3db/oct, axes of vibration: X/Y/Z Time: 30 min/axis
Mechanical shock	3	30g, 6ms, 3 axes, 6 directions, 3 time/direction
Thermal shock	3	-40 °C to +100 °C, unit temperature 20 cycles
Thermal cycling	3	-40 °C to +55 °C, temperature change rate: 1 °C/min, cycles: 2 cycles
Humidity	3	40 °C, 95%RH, 48h
Solder ability	15	IPC J-STD-002C-2007

## Application Notes

### Typical Application

Below is the typical application of the AVO240-48S12 series power supply.

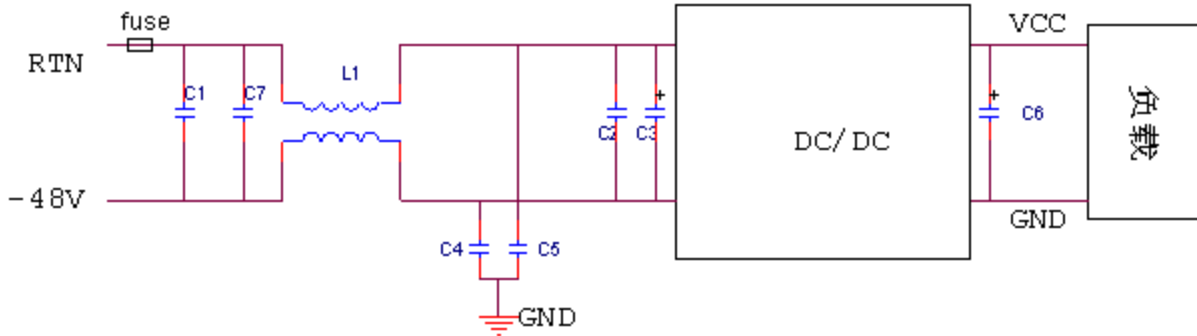

Figure 28 Typical application

Recommended input fuse:Littel fuse 0314015.P 15A

C1 C7:SMDceramic-100V-2.2uF-X7R-1210

C2 : SMDceramic-100V-100nF-±10%-X7R-1206

C3: 100μF/100V electrolytic capacitor, High frequency and low ESR

C6:1000μF/25V electrolytic capacitor, High frequency and low ESR

C4 C5: SMD ceramic-0.1U/1000V/X7R- 2220

L1: 809uH-±25%-9.7A-R5K-28\*26\*12.7mm

### Remote ON/OFF

Either positive or negative remote ON/OFF logic is available in AVO240-48S12 series. The logic is CMOS and TTL compatible.

The voltage between pin Remote ON/OFF and pin  $V_{in-}$  must not exceed the range listed in table 3 to ensure proper operation. The external Remote ON/OFF circuit is highly recommended as shown in figure 29.

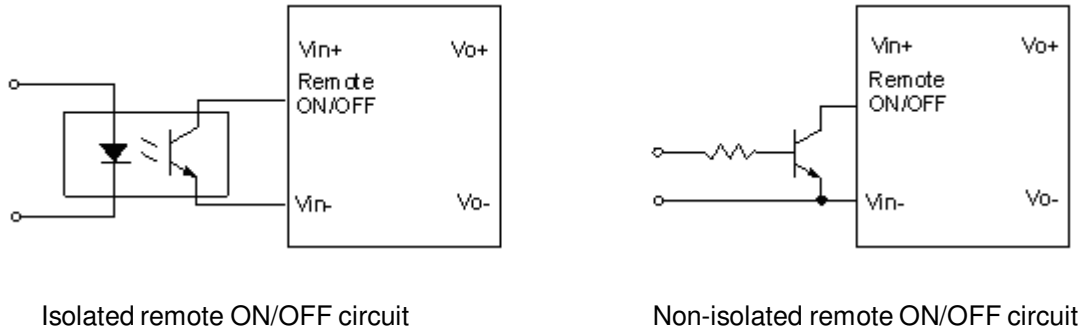

Figure 29 External Remote ON/OFF circuit

**Input Ripple & Output Ripple & Noise Test Configuration**

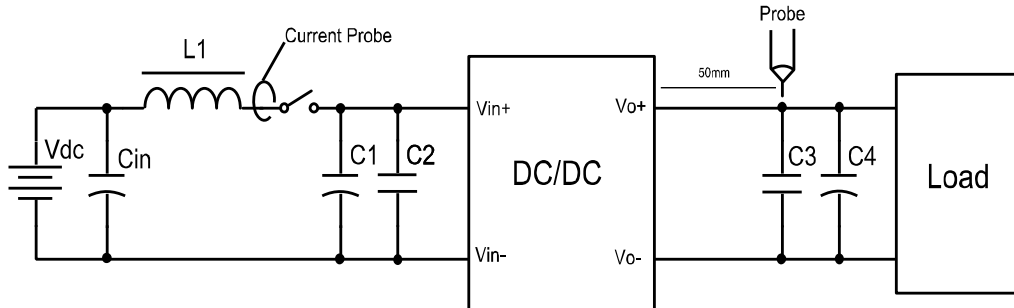

Figure 30 Input ripple & inrush current, output ripple & noise test configuration

V<sub>dc</sub>: DC power supply

L1: 12μH

C<sub>in</sub>: 220μF/100V typical

C1: 220μF/100V electrolytic capacitor, High frequency and low ESR

C2 C3: SMDceramic-100V-1000nF-X7R-1210

C4: 1000μF/25V electrolytic capacitor, High frequency and low ESR

Note: Using a coaxial cable with series 50Ω resistor and 0.68μF ceramic capacitor or a ground ring of probe to test output ripple & noise is recommended.

### **Soldering**

The product is intended for standard manual or wave soldering.

When wave soldering is used, the temperature on pins is specified to maximum 260 °C for maximum 7s.

When soldering by hand, the iron temperature should be maintained at 300 °C ~ 380 °C and applied to the converter pins for less than 10s. Longer exposure can cause internal damage to the converter.

Cleaning of solder joint can be performed with cleaning solvent IPA or simulative.



## Hazardous Substances Announcement (RoHS of China)

Parts	Hazardous Substances					
	Pb	Hg	Cd	Cr <sup>6+</sup>	PBB	PBDE
AVO240-48S12-6L	x	x	x	x	x	x
AVO240-48S12B-6L	x	x	x	x	x	x

x: Means the content of the hazardous substances in all the average quality materials of the part is within the limits specified in SJ/T-11363-2006

√: Means the content of the hazardous substances in at least one of the average quality materials of the part is outside the limits specified in SJ/T11363-2006

Artesyn Embedded Technologies has been committed to the design and manufacturing of environment-friendly products. It will reduce and eventually eliminate the hazardous substances in the products through unremitting efforts in research. However, limited by the current technical level, the following parts still contain hazardous substances due to the lack of reliable substitute or mature solution:

1. Solders (including high-temperature solder in parts) contain plumbum.
2. Glass of electric parts contains plumbum.
3. Copper alloy of pins contains plumbum

### WORLDWIDE OFFICES

#### Americas

2900 S.Diablo Way  
 Tempe, AZ 85282  
 USA  
 +1 888 412 7832

#### Europe (UK)

Waterfront Business Park  
 Merry Hill, Dudley  
 West Midlands, DY5 1LX  
 United Kingdom  
 +44 (0) 1384 842 211

#### Asia (HK)

14/F, Lu Plaza  
 2 Wing Yip Street  
 Kwun Tong, Kowloon  
 Hong Kong  
 +852 2176 3333



[www.artesyn.com](http://www.artesyn.com)

While every precaution has been taken to ensure accuracy and completeness in this literature, Artesyn Embedded Technologies assumes no responsibility, and disclaims all liability for damages resulting from use of this information or for any errors or omissions. Artesyn Embedded Technologies, Artesyn and the Artesyn Embedded Technologies logo are trademarks and service marks of Artesyn Technologies, Inc. All other names and logos referred to are trade names, trademarks, or registered trademarks of their respective owners.  
 © 2014 All rights reserved.

For more information: [www.artesyn.com/power](http://www.artesyn.com/power)  
 For support: [productsupport.ep@artesyn.com](mailto:productsupport.ep@artesyn.com)