

PART NAME

NEMA 4X DIE CAST ALUMINUM ENCLOSURE

PART No.

AN-1316, AN-1316-G, AN-2816 & AN-2816-B

REV. DATE

3-24-10

MATERIAL: ALUMINUM ALLOY #ADC-12

FINISH: NATURAL (NO SUFFIX)

GRAY (SUFFIX -G)

SMOOTH BLACK (SUFFIX -B)

NOTES:

- 1) FOUR (4) M4x0.7 x 30mm (1.181") LG. SCREWS SUPPLIED FOR ASSEMBLY OF COVER TO BODY.
- 2) ALL HOLE DIAMETERS HAVE ±0.005 TOLERANCE ALL OTHER DIMENSIONS HAVE ±0.015 TOLERANCE

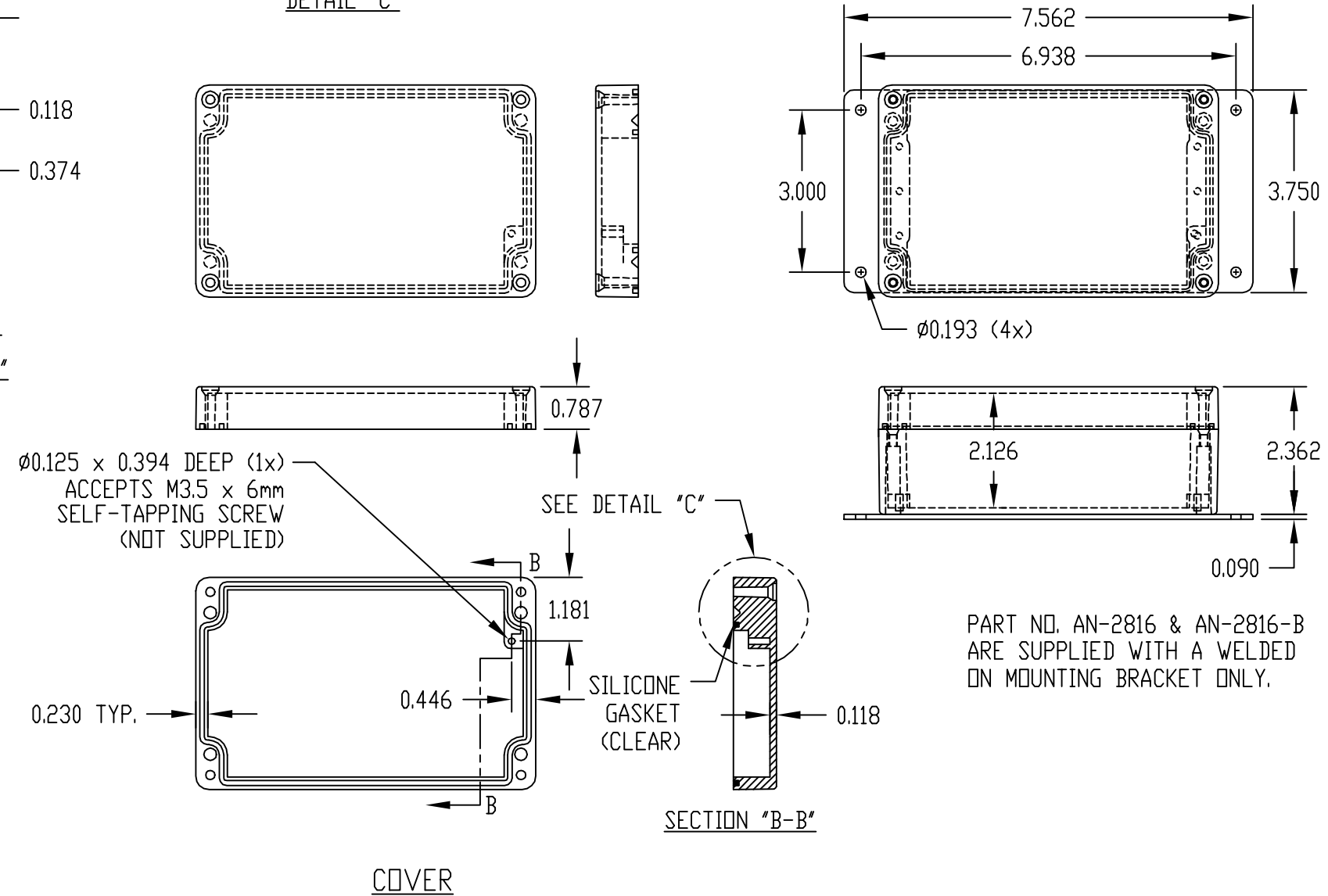
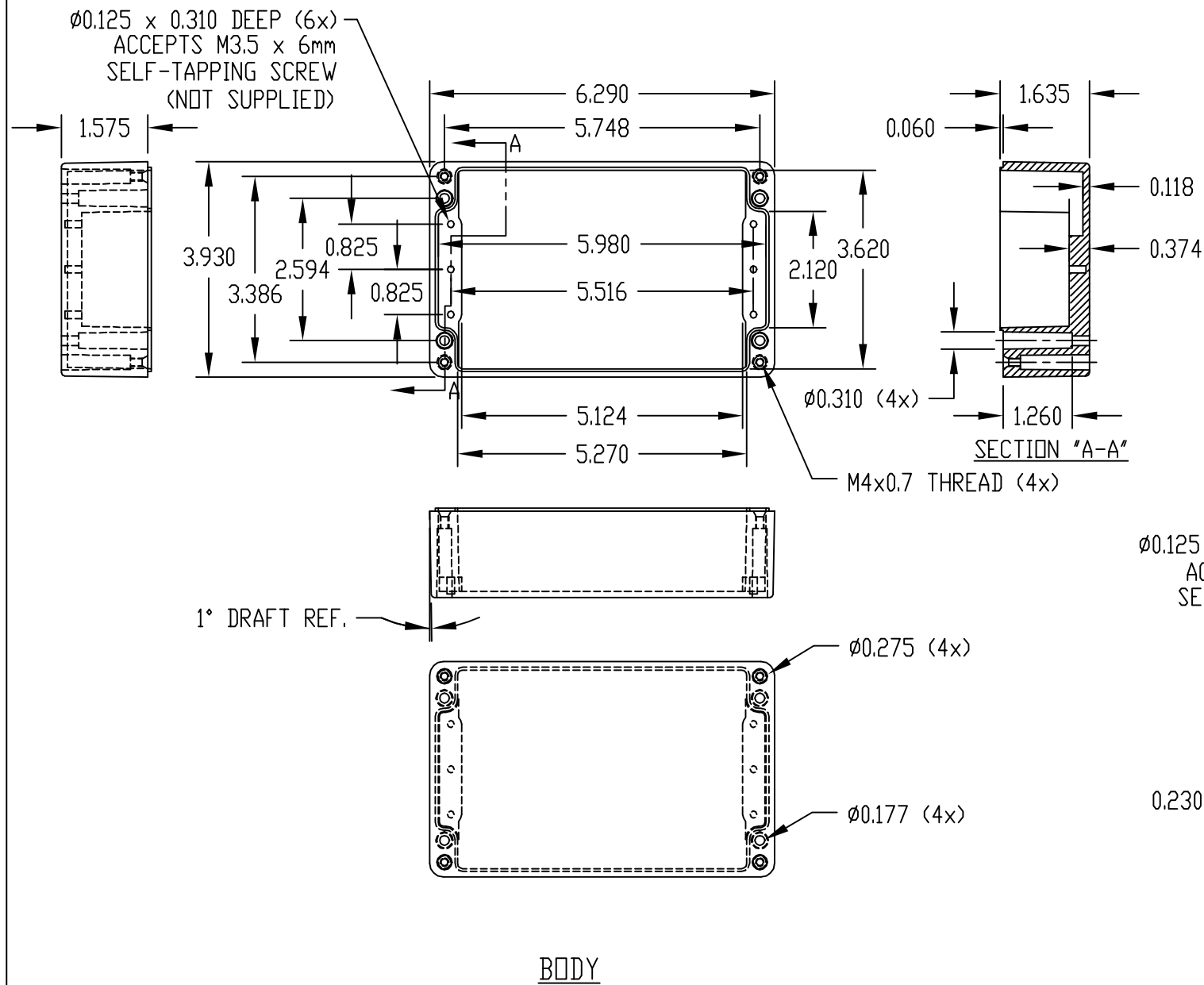
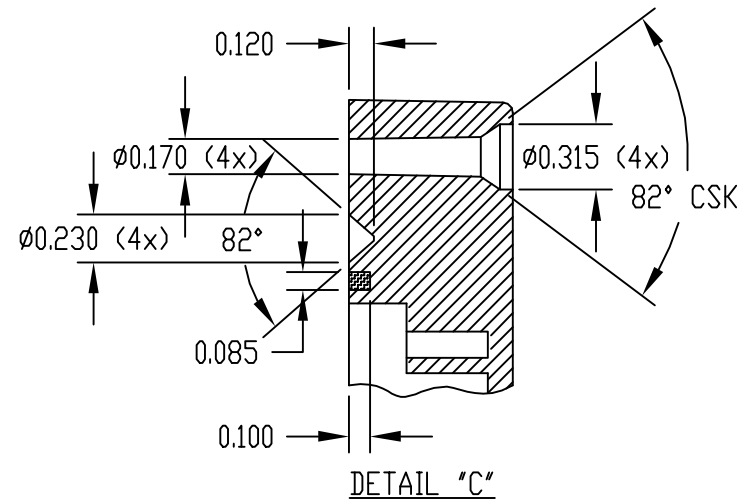

PART NO. AN-2816 & AN-2816-B ARE SUPPLIED WITH A WELDED ON MOUNTING BRACKET ONLY.