

THIS DOCUMENT IS THE PROPERTY OF
KEYSTONE ELECTRONICS CORP. AND
SHALL NOT BE REPRODUCED, DISTRIBUTED
OR USED AS A BASIS FOR MANUFACTURE
WITHOUT PRIOR WRITTEN PERMISSION
FROM KEYSTONE ELECTRONICS CORP.

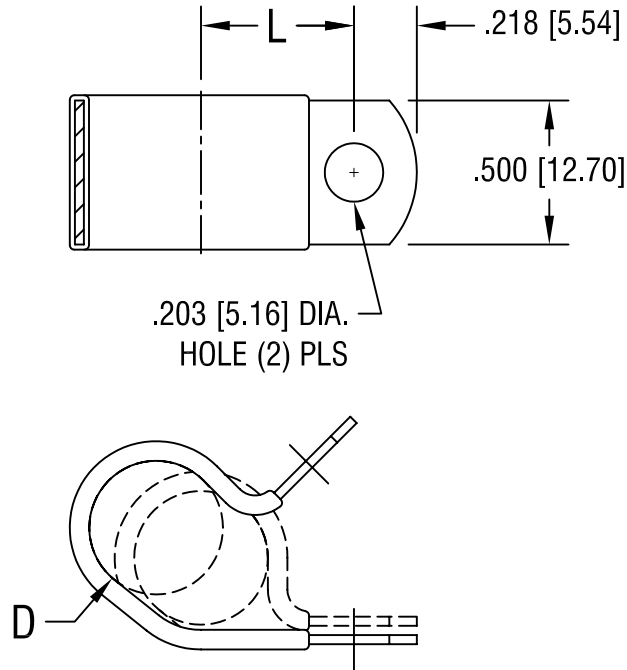

'L' DIM.	'D' FOR DIA.
.781 [19.84]	.937 [23.80]

KEYSTONE ELECTRONICS CORP.			
ASTORIA, N.Y. 11105-2017			
PART NAME INSULATED STEEL CABLE CLAMP			
MATERIAL .032 [.81] TH'K STEEL, BLACK VINYL			
FINISH ZINC PLATE CLEAR CHROMATE		DRN BY BOONE	DATE 10.20.99
		APP'D LN	SCALE NONE
DATE 10.18.06	CHANGE AS PER ECN 06-070	REV. A	TOLERANCES INCH [MM] DECIMAL ±.010 [±0.25] ANGULAR ± 1° UNLESS OTHERWISE SPECIFIED
		CODE C/M	DWG NO. 8133

DATE	DESCRIPTION	REV.
10.18.06	CHANGE AS PER ECN 06-070	A