

NO.	MASSE / DIMENSION
A	66.3
B	2-18UNS-2A
C	75
D	43.5
E	45
F	12.6

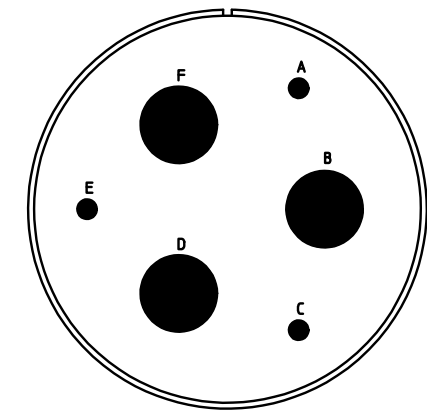
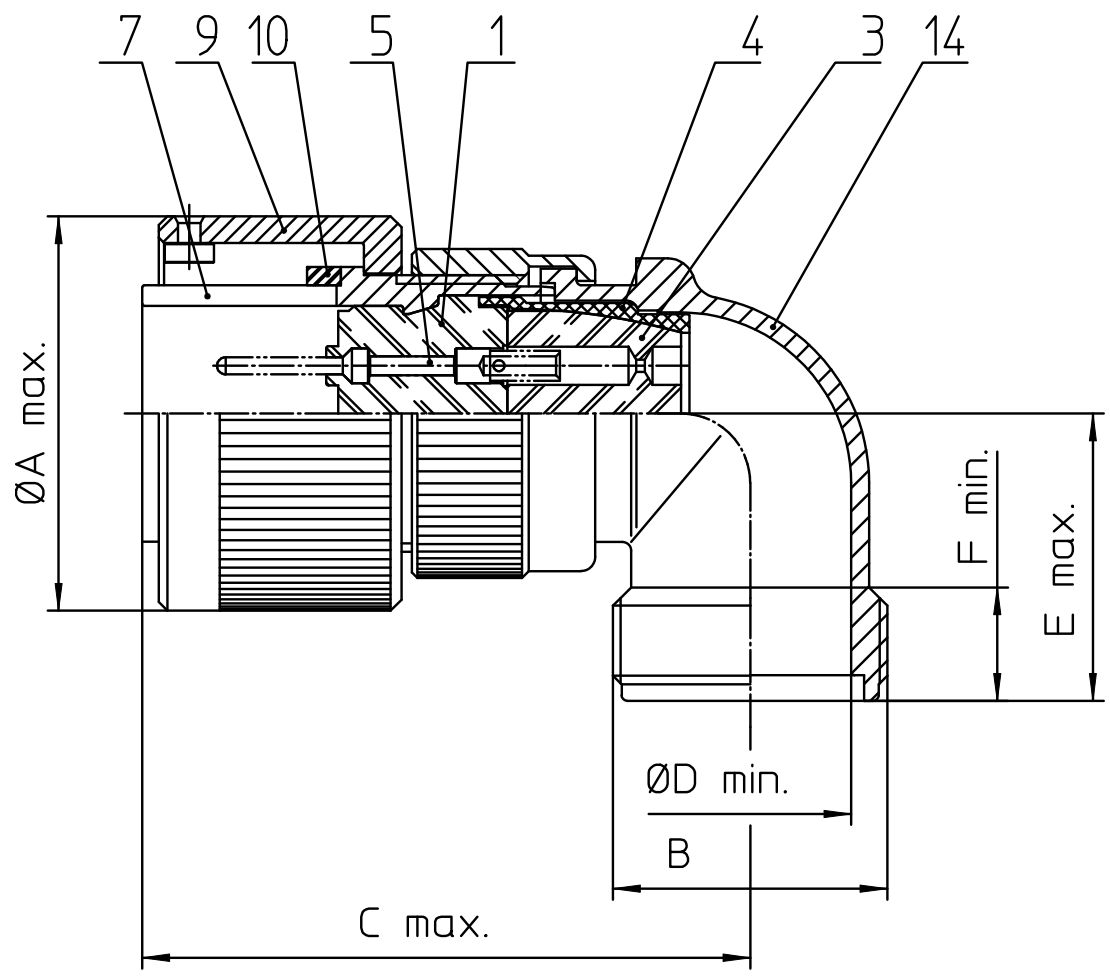

NO.	BESCHREIBUNG / DESCRIPTION
1	ISOLIERKÖRPER STIFT / INSULATOR PIN
3	DICHTKÖRPER / GROMMET
4	ENDRING / ENDRING
5	KONTAKTSTIFT/ CONTACT PIN
7	ZYLINDERGHÄUSE / BARREL
9	ÜBERWURFMUTTER / COUPLING NUT
10	DICHTRING FRONT / FRONT SEALING RING
11	SCHIRMKRANZ/SHIELDING BRAID
14	F-ENDGEHÄUSE / F-ENDBELL

Note: Due to an automatic nomenclature system, numbers generated may not be sequential.  
 Specification and Dimensions subject to change  
 Drawings illustrate normal insulator positioning

<b>Material Specification:</b>	
Shell Material:	Aluminium alloy
Shell Plating:	Olive drab chromate over cadmium (conductive)
Insulator Material:	CR-Elastomere
Contact Material:	Copper alloy
Contact Plating:	Hard silver

all dimensions are in mm  
 Dimensions without tolerance indications are general tolerances in acc. with DIN7168m

drawing for  
**CUSTOMER**

description **CA3108F36-3P-B-15**  
**Plug, 90° shielded**  
 Shielded with endbell for shielded braids & heat shrinkable boots  
 AWG Crimp / Pin / Layout: 36-3