

ROHM Sensor Shield Manual

Jun 09, 2016
Sensor Application G

Sensor board lineup

No.	Sensor	Type Name
1	Accelerometer	KX022-1020
2	Pressure sensor	BM1383GLV
3	Magnetic sensor	BM1422GMV
4	ALS/PS sensor	RPR-0521RS
5	Color sensor	BH1745NUC
6	Hall sensor	BD7411G
7	Temperature sensor	BD1020HFV
8	UV sensor	ML8511A

ROHM Sensor Shield

- Shield for Arduino Uno
- Size: 88mm x 63mm
- I/F: I2C/Analog/Digital
- Operation Voltage: 5V, 3V and 1.8V
 - Embedded Level Shifter
 - GPIO : FAIRCHILD FXMA108
 - I2C : NXP PCA9306
- I2C pull-up register

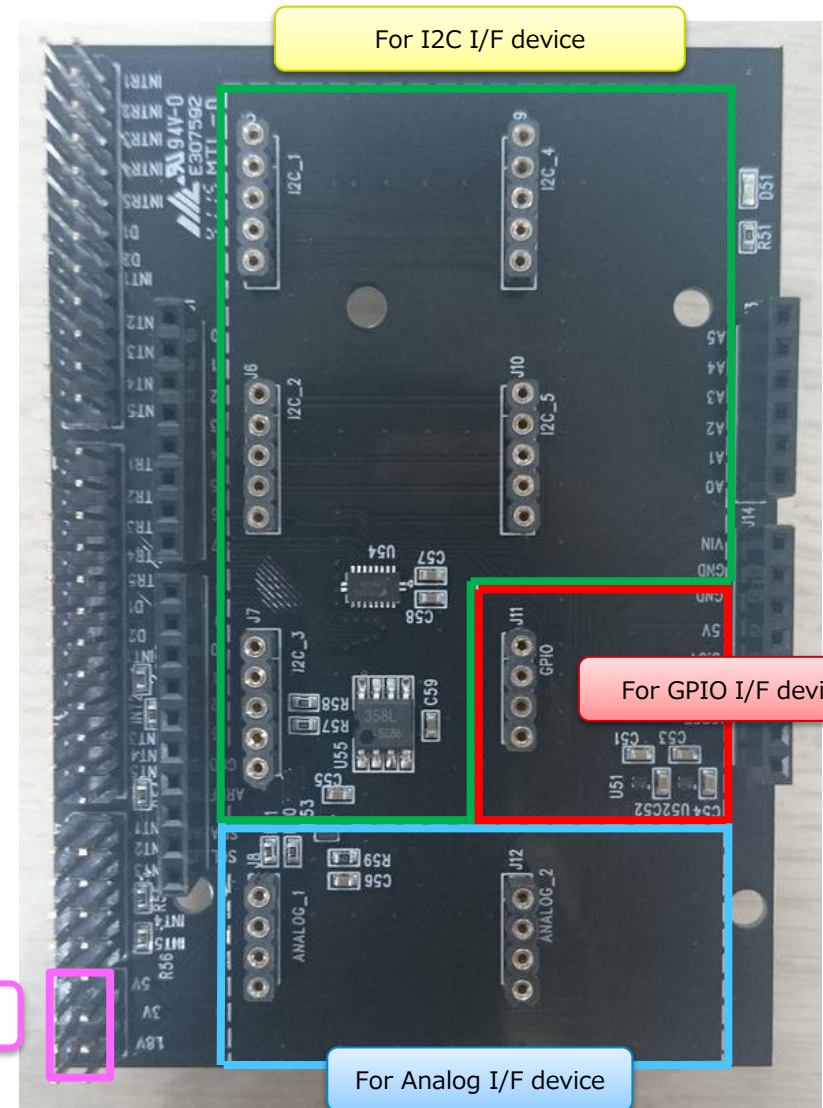

Feature of each sensor board

- Through Hall: I/F pin, VDD and GND Pin (Fig.1)
- Board Size: 20mm x 20mm
- Board Color: Black
- The board has pattern to change Slave address.(Fig.2)
 - KX022-1020, BM1422GMV, BH1745NUC
- M3 Size Hole to attached some device.

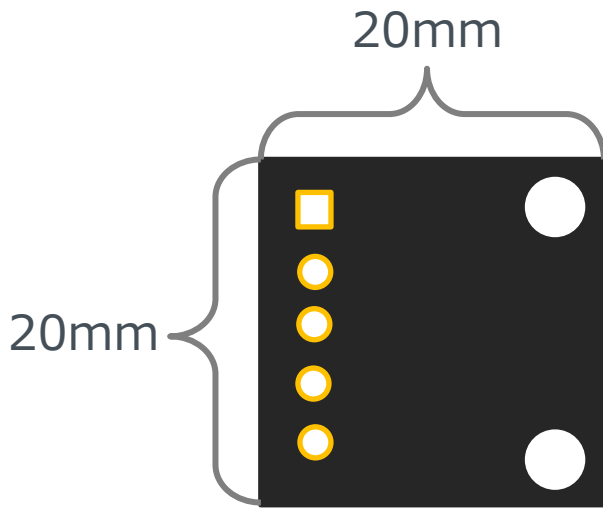

Fig.1

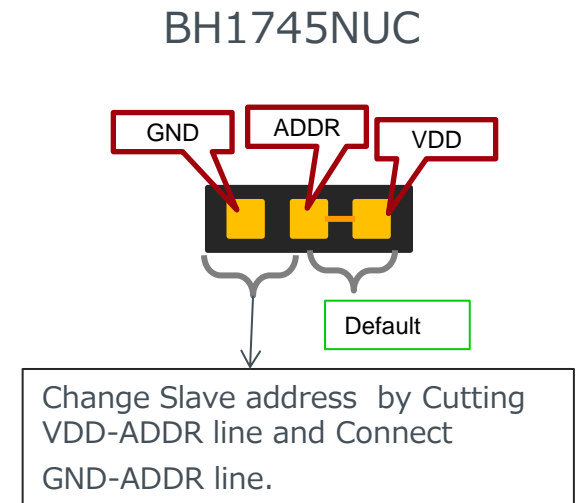
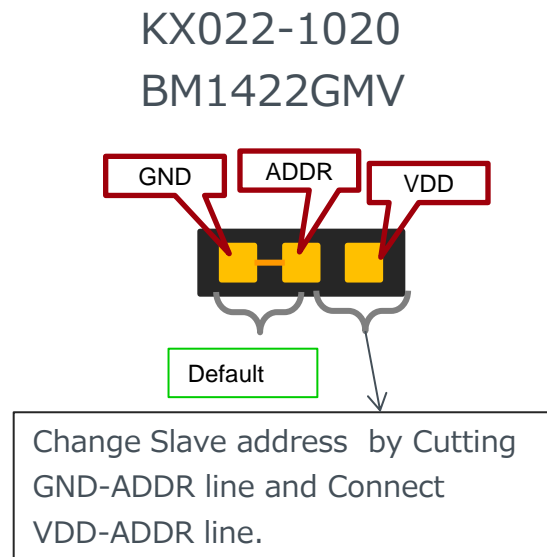

Fig.2

Manual of Arduino Sensor Shield and Sensor Board

1. Connect between Arduino and Sensor Shield

USB Connector



2. Select Sensor Board which connect to Sensor Shield

ex) Connect BM1383GLV to I2C_1

3. Voltage Setting of Sensor Shield

ex) 1.8V

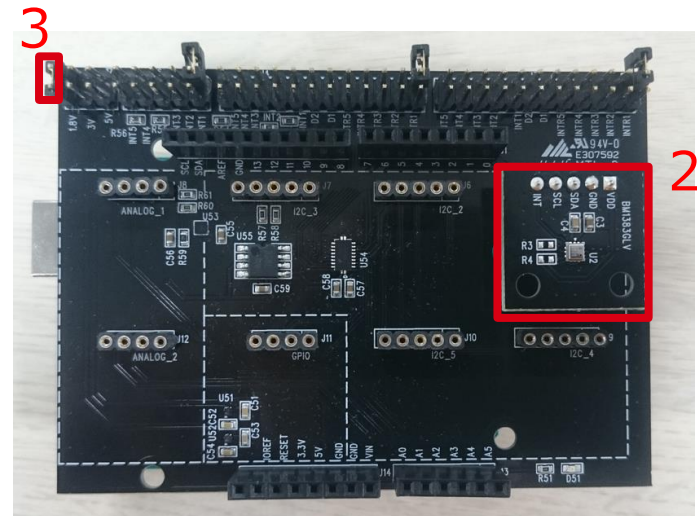

4. Connect PC to Arduino by USB Cable

5. Copy Arduino program to libraries of Arduino

- Recommended system requirements : Arduino IDE version 1.6.7 or above
- Please download Arduino IDE from <http://www.arduino.cc>

6. Execute Arduino IDE(v1.6.7)

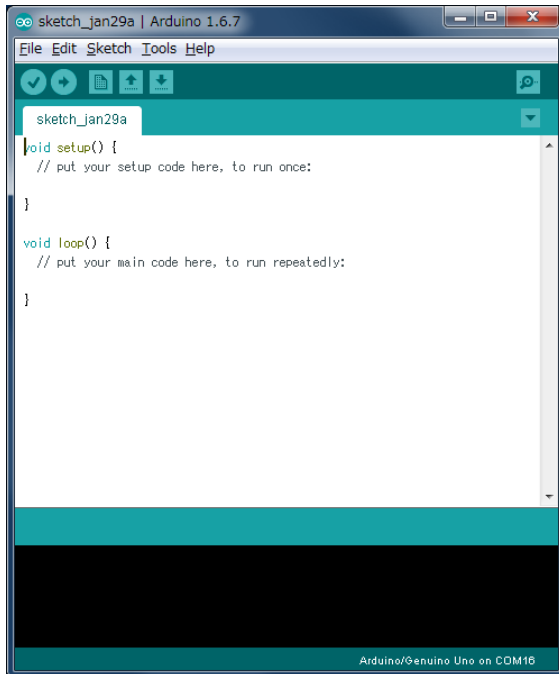

7. Select Program

- File->Examples->BM1383GLV->example->BM1383GLV

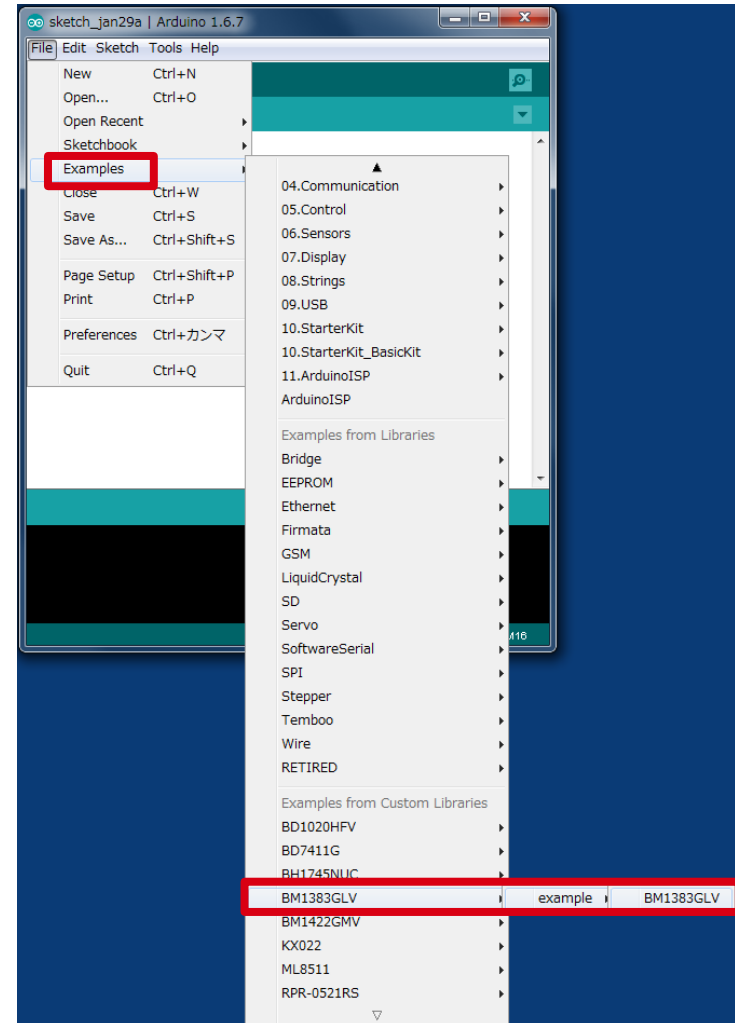

8. Change Setting of Board and Port

- (1) Tools->Board ⇒ "Arduino/Genuino Uno",
- (2) Port ⇒ "COMxx(Arduino/Genuino Uno)"

COM Port Number depends on PC.

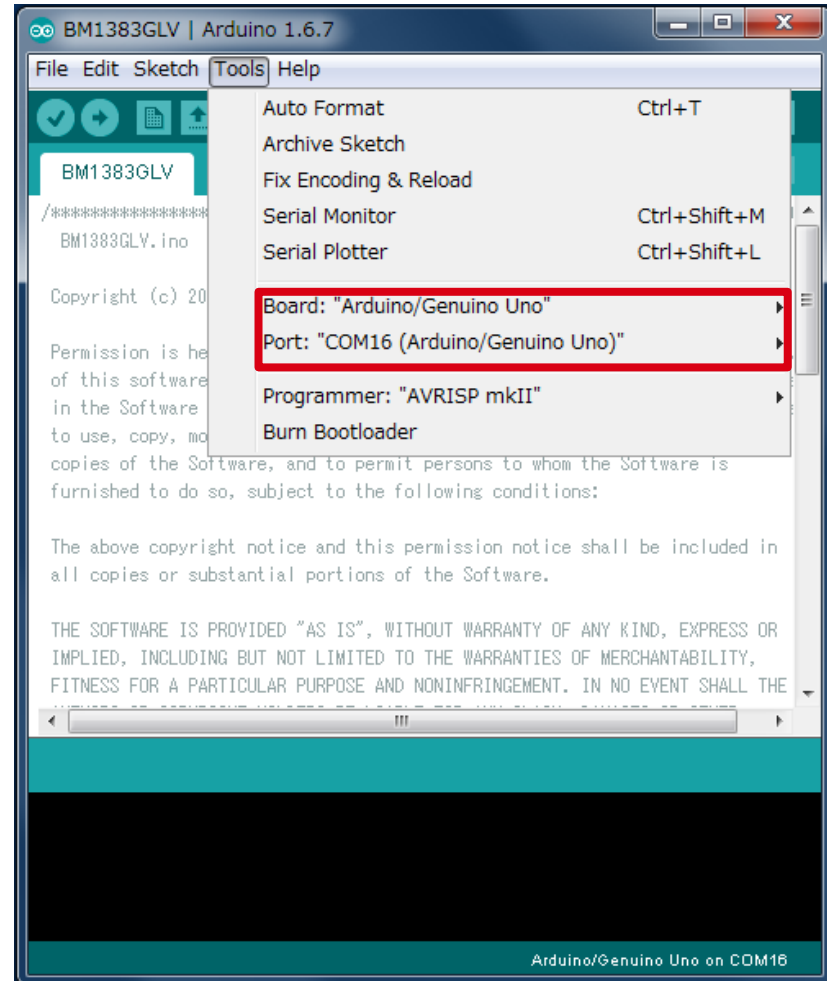

9. Write Program (Push Upload Button)

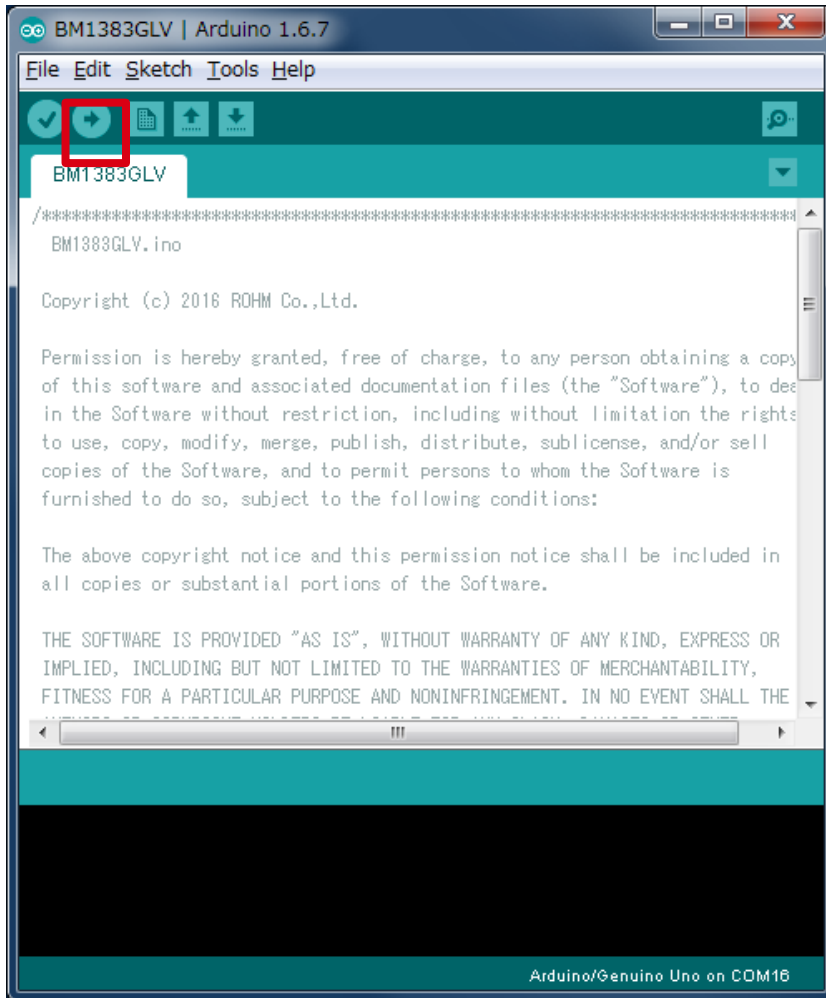

10. Check status whether Write Program is OK or Not. OK log is "Done uploading".

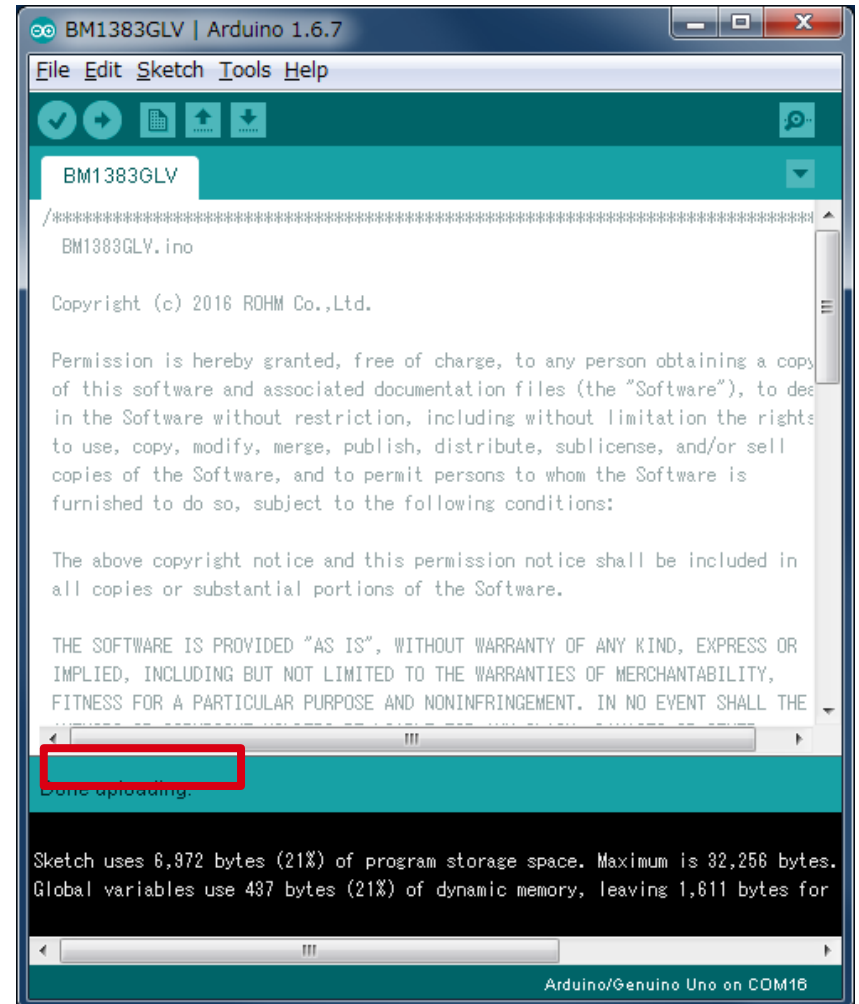

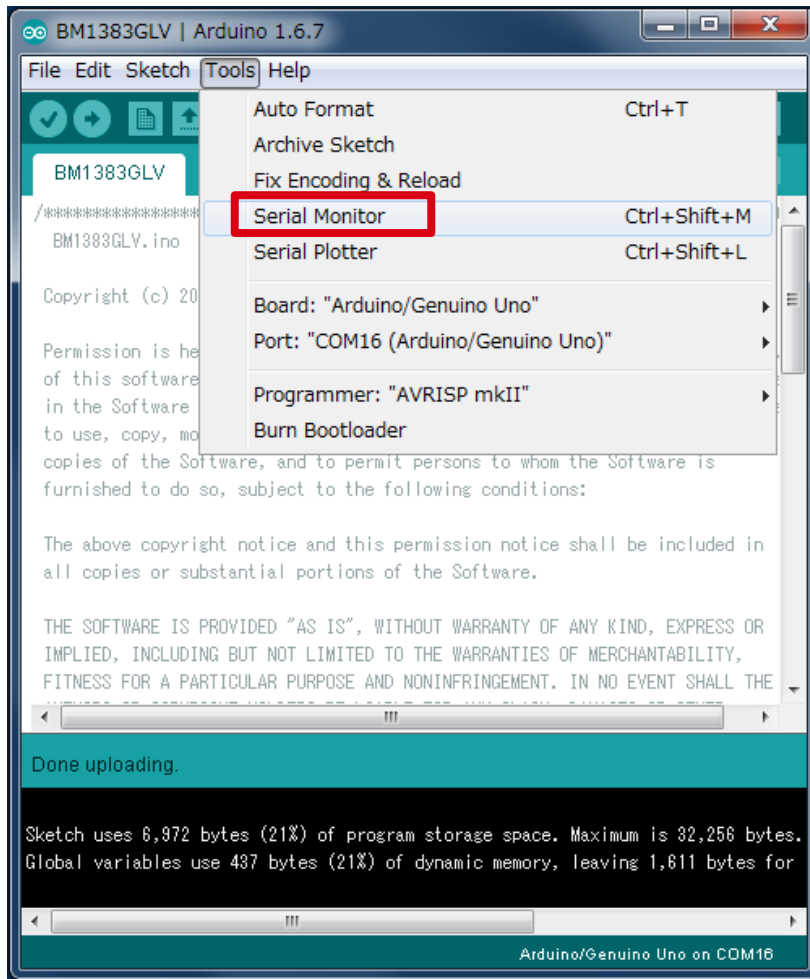

11. Select Tools->Serial Monitor

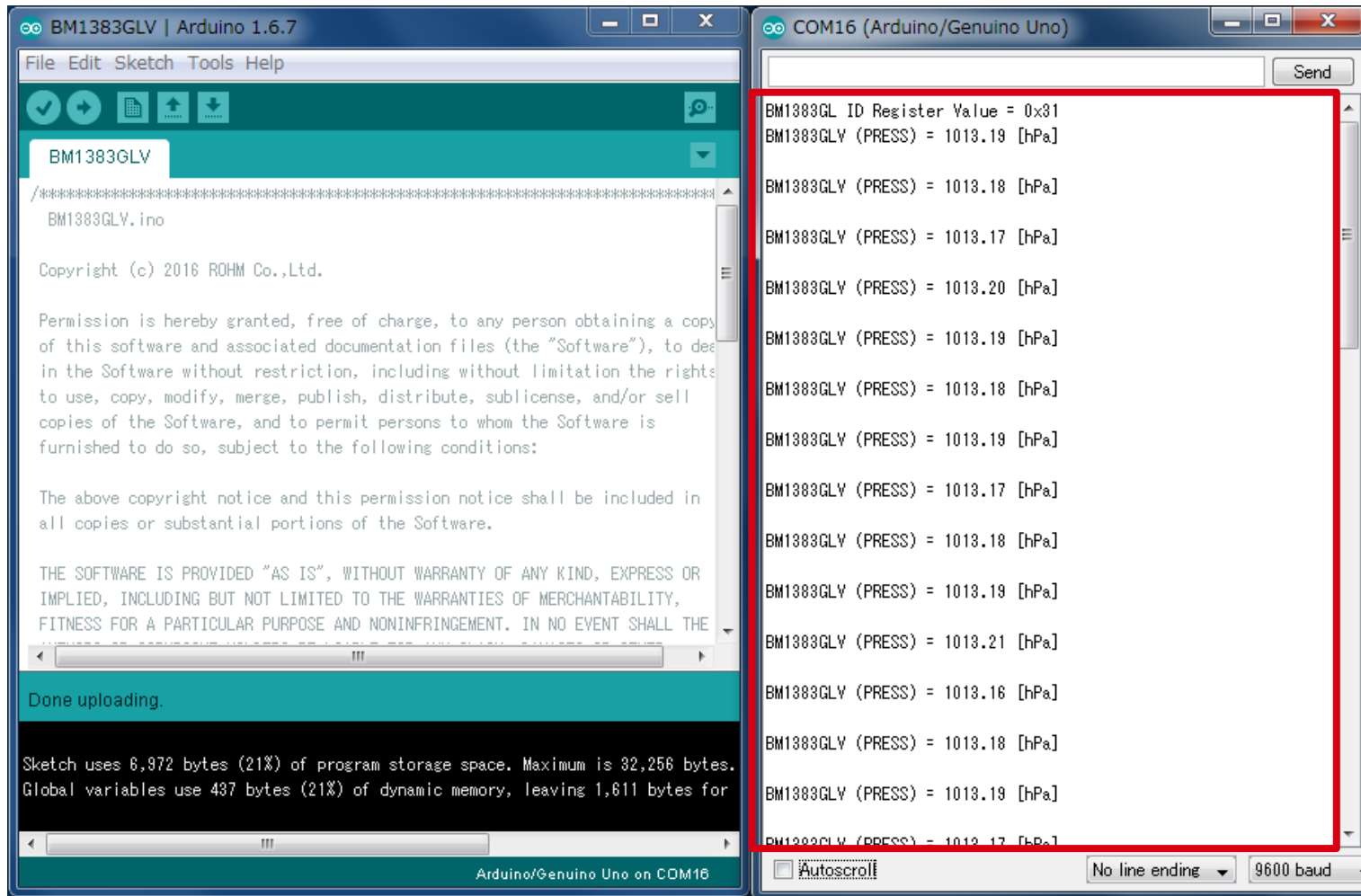

12. Check log of Serial Monitor

In the case of GPIO I/F (BD7411)

[Program]

File->Examples->
BD7411G->example->
BD7411

⚠ Caution

When Sample program
of BD7411 is installed,
Take off BD7411 Sensor
Board.

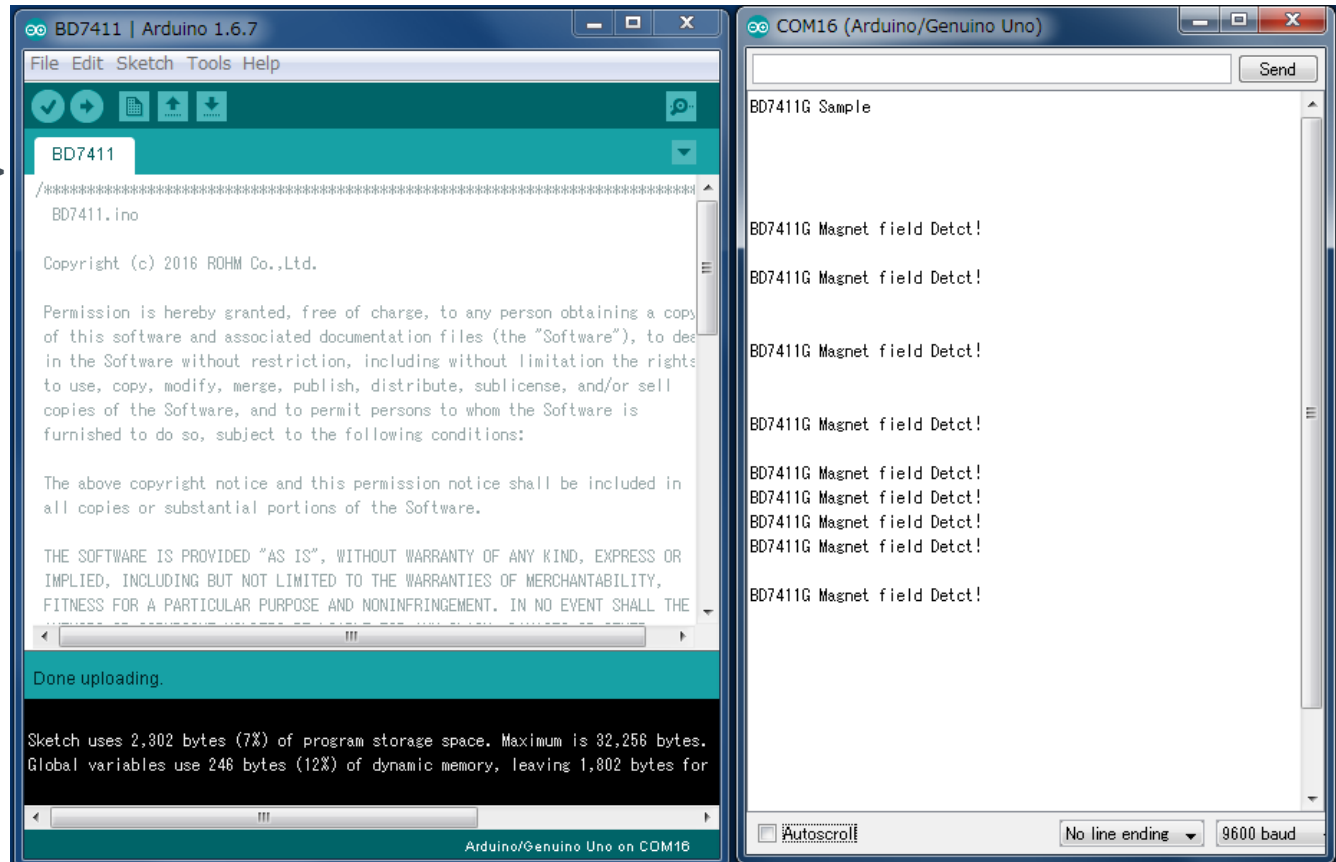

[Result of Sample Program]

Display message at 500ms interval when BD7411 output is low.

In the case Analog I/F (BD1020)

[Program]

File->Examples->

BD1020HFV->example->

BD1020

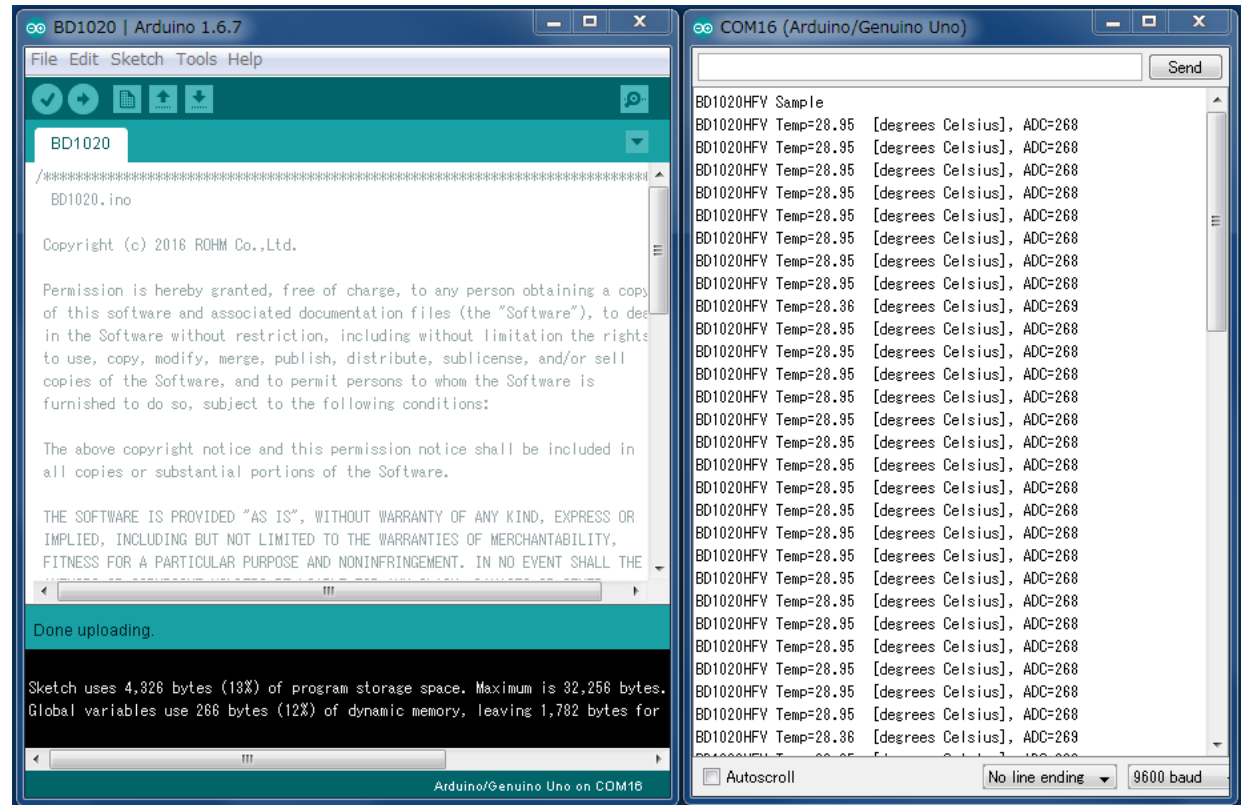

[Result of Sample Program]

Display output data of Temperature sensor at 500ms interval.

Connection Point of Sample Program

No.	Sensor	Type Name	
1	Accelerometer	KX022-1020	I2C_1,I2C_2,I2C_3,I2C_4,I2C_5
2	Pressure sensor	BM1383GLV	I2C_1,I2C_2,I2C_3,I2C_4,I2C_5
3	Magnetic sensor	BM1422GMV	I2C_1,I2C_2,I2C_3,I2C_4,I2C_5
4	ALS/PS sensor	RPR-0521RS	I2C_1,I2C_2,I2C_3,I2C_4,I2C_5
5	Color sensor	BH1745NUC	I2C_1,I2C_2,I2C_3,I2C_4,I2C_5
6	Hall sensor	BD7411G	GPIO
7	Temperature sensor	BD1020HFV	ANALOG_2
8	UV sensor	ML8511A	ANALOG_1

Selectable Power Supply

No.	Sensor	Type Name		Recommended Operating Voltage [V]			Selectable Power [V]		
				Min.	Typ.	Max	1.8	3	5
1	Accelerometer	KX022-1020	Vdd	1.71	2.5	3.6	○	○	
			Vio	1.7	-	Vdd			
2	Pressure sensor	BM1383GLV	VDD	1.7	-	3.6	○	○	
3	Magnetic sensor	BM1422GMV	AVDD	1.7	-	2.0	○		
			DVDD	1.7	-	2.0			
4	ALS/PS sensor	RPR-0521RS	VCC	2.5	3.0	3.6		○	
			VLEDA	2.8	3.0	5.5			
5	Color sensor	BH1745NUC	Vcc	2.3	2.5	3.6		○	
6	Hall sensor	BD7411G	VDD	4.5	5.0	5.5			○
7	Temperature sensor	BD1020HFV	VDD	2.4	3.0	5.5		○	○
8	UV sensor	ML8511A	VDD	2.7	3.3	3.6		○	

I2C Device Address List

No.	Sensor	Type Name	Device Address(7bit)
1	Accelerometer	KX022-1020	0x1E/0x1F
2	Pressure sensor	BM1383GLV	0x5D
3	Magnetic sensor	BM1422GMV	0x0E/0x0F
4	ALS/PS sensor	RPR-0521RS	0x38
5	Color sensor	BH1745NUC	0x38/0x39

Blue character is default slave address

