

4x4 Key click

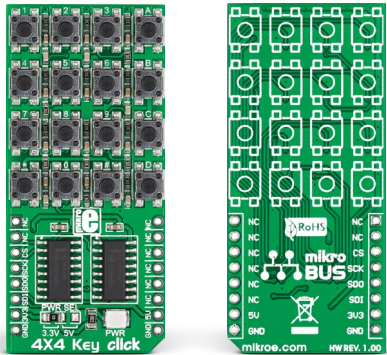

1. Introduction

4x4 Key click carries a 16 button keypad with two shift registers, allowing you to connect a keypad to a microcontroller without using too many I/Os. 4x4 Key click communicates with the target board MCU through mikroBUS™ SPI pins (CS, SCK, MISO, MOSI). The board is designed to use either a 3.3V or 5V power supply.

2. Soldering the headers

Before using your click board™, make sure to solder 1x8 male headers to both left and right side of the board. Two 1x8 male headers are included with the board in the package.

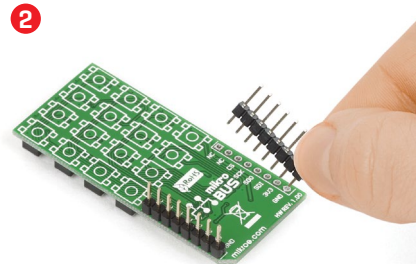
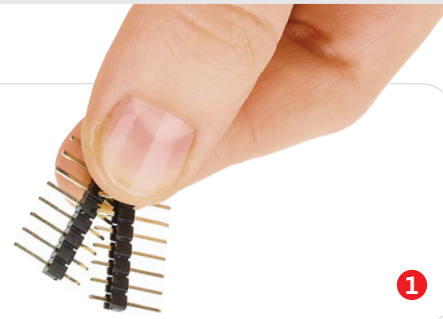

Turn the board upside down so that the bottom side is facing you upwards. Place shorter pins of the header into the appropriate soldering pads.

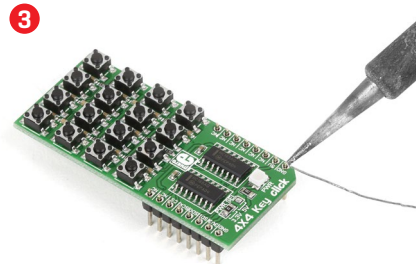

Turn the board upward again. Make sure to align the headers so that they are perpendicular to the board, then solder the pins carefully.

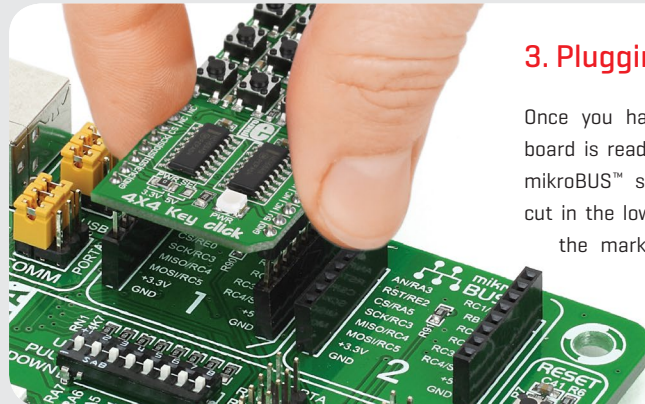

3. Plugging the board in

Once you have soldered the headers your board is ready to be placed into the desired mikroBUS™ socket. Make sure to align the cut in the lower-right part of the board with the markings on the silkscreen at the mikroBUS™ socket. If all the pins are aligned correctly, push the board all the way into the socket.

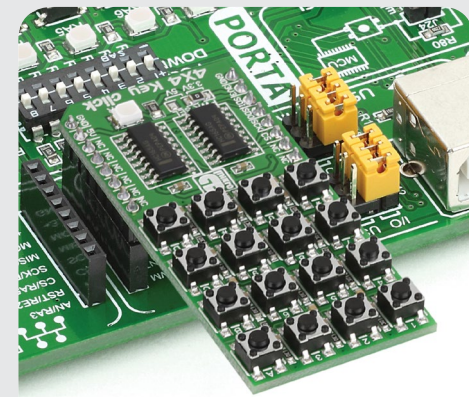

4. Essential features

The design of 4x4 Key click — inputs are read by a pair of connected 8-bit parallel-in serial-out shift registers — allows for multiple key presses at the same time. You can press all 16 buttons simultaneously and each will be registered. For ease of use, each button has silkscreen markings. The right-most column is marked with letters A-D, the other 12 buttons are marked like a telephone keypad.

click
BOARD™
www.mikroe.com



4x4 Key click manual
ver 1.00



010000078952

5. Schematic

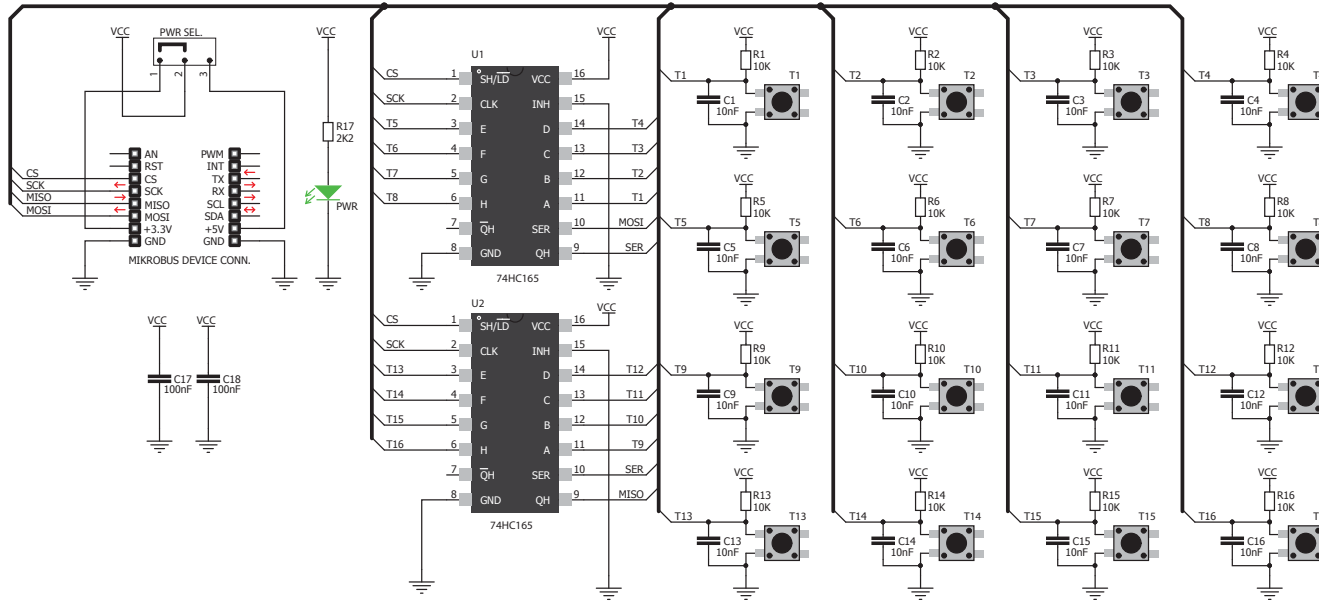

6. Dimensions

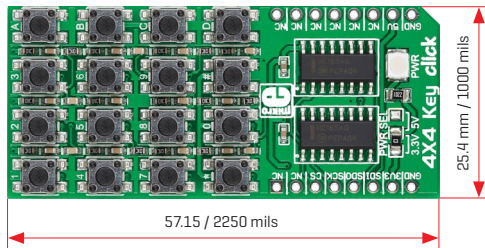

	mm	mils
LENGTH	57.15	2250
WIDTH	25.4	1000
HEIGHT*	5.25	207

* without headers

7. SMD jumper

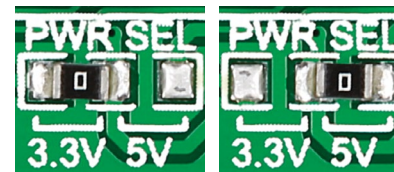

4x4 Key click has a PWR SEL jumper [zero ohm resistor] that lets you switch the board form 3.3V to 5V power supply.

8. Code examples

Once you have done all the necessary preparations, it's time to get your click board™ up and running. We have provided examples for mikroC™, mikroBasic™ and mikroPascal™ compilers on our **Libstock** website. Just download them and you are ready to start.



9. Support

MikroElektronika offers **free tech support** [www.mikroe.com/support] until the end of the product's lifetime, so if something goes wrong, we're ready and willing to help!



10. Disclaimer

MikroElektronika assumes no responsibility or liability for any errors or inaccuracies that may appear in the present document. Specification and information contained in the present schematic are subject to change at any time without notice.

Copyright © 2015 MikroElektronika.
All rights reserved.