

Three phase full Bridge

with Trench MOSFETs
in DCB isolated high current package

$V_{DSS} = 150\text{ V}$
 $I_{D25} = 50\text{ A}$
 $R_{DSon\ typ.} = 19\text{ m}\Omega$

Preliminary Data

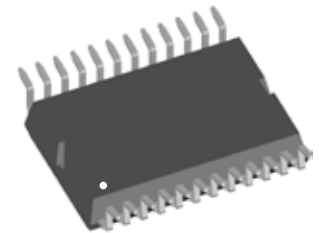
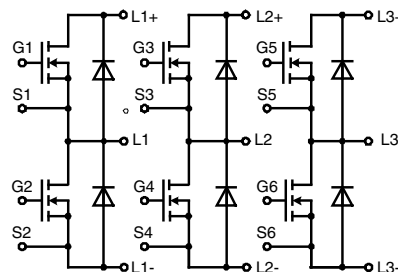

MOSFETs			
Symbol	Conditions	Maximum Ratings	
V_{DSS}	$T_{VJ} = 25^{\circ}\text{C to } 150^{\circ}\text{C}$	150	V
V_{GS}	continous	± 15	V
	transient	± 20	V
I_{D25}	$T_C = 25^{\circ}\text{C}$	50	A
I_{D90}	$T_C = 90^{\circ}\text{C}$	38	A
I_{D110}	$T_C = 110^{\circ}\text{C}$	33	A
I_{F25}	$T_C = 25^{\circ}\text{C}$ (diode)	150	A
I_{F90}	$T_C = 90^{\circ}\text{C}$ (diode)	85	A
I_{F110}	$T_C = 110^{\circ}\text{C}$ (diode)	65	A

Applications

AC drives

- in automobiles
 - electric power steering
 - starter generator
- in industrial vehicles
 - propulsion drives
 - fork lift drives
- in battery supplied equipment

Features

- MOSFETs in trench technology:
 - low R_{DSon}
 - optimized intrinsic reverse diode
- package:
 - high level of integration
 - high current capability
 - aux. terminals for MOSFET control
 - terminals for soldering or welding connections
 - isolated DCB ceramic base plate with optimized heat transfer
- Space and weight savings

Symbol	Conditions	Characteristic Values			
		$(T_{VJ} = 25^{\circ}\text{C}, \text{ unless otherwise specified})$			
		min.	typ.	max.	
$R_{DSon}^{1)}$	on chip level at $V_{GS} = 10\text{ V}; I_D = 38\text{ A}$		19	24	$\text{m}\Omega$
			38		$\text{m}\Omega$
$V_{GS(th)}$	$V_{DS} = 20\text{ V}; I_D = 1\text{ mA}$	2.5		4.5	V
I_{DSS}	$V_{DS} = V_{DSS}; V_{GS} = 0\text{ V}$		0.5	5	μA mA
I_{GSS}	$V_{GS} = \pm 20\text{ V}; V_{DS} = 0\text{ V}$			0.2	μA
Q_g	$V_{GS} = 10\text{ V}; V_{DS} = 75\text{ V}; I_D = 38\text{ A}$		97		nC
Q_{gs}			29		nC
Q_{gd}			30		nC
C_{iss}	$V_{GS} = 10\text{ V}; V_{DS} = 25\text{ V}; f = 1\text{ MHz}$		5800		pF
C_{oss}			490		pF
C_{rss}			85		pF
$t_{d(on)}$	inductive load $V_{GS} = 10\text{ V}; V_{DS} = 75\text{ V}$ $I_D = 38\text{ A}; R_{G(on)} = 39\ \Omega; R_{G(off)} = 4.7\ \Omega$ $T_J = 125^{\circ}\text{C}$		120		ns
t_r			50		ns
$t_{d(off)}$			100		ns
t_f			25		ns
E_{on}			0.25		mJ
E_{off}			0.05		mJ
E_{recoff}			0.02		mJ
R_{thJC}			1.0		K/W
R_{thJH}	with heat transfer paste (IXYS test setup)		1.3	1.6	K/W

 $^{1)} V_{DS} = I_D \cdot (R_{DS(on)} + 2R_{Pin\ to\ Chip})$

Source-Drain Diode				
Symbol	Conditions	Characteristic Values		
		(T _J = 25°C, unless otherwise specified)		
		min.	typ.	max.
V _{SD}	(diode) I _F = 38 A; V _{GS} = 0 V	0.85	1.0	V
t _{rr}	I _F = 38 A; -di _F /dt = 900 A/μs; R _{G(on)} = 39 Ω; V _R = 75 V; T _{VJ} = 125°C		65	ns
Q _{RM}			1.6	μC
I _{RM}			40	A

Component				
Symbol	Conditions	Maximum Ratings		
I _{RMS}	per pin in main current paths (L+, L-, N-, L1, L2, L3) may be additionally limited by external connections 2 pins for output L1, L2, L3		75	A
T _J			-55...+175	°C
T _{stg}			-55...+125	°C
V _{ISOL}	I _{ISOL} ≤ 1 mA, 50/60 Hz, f = 1 minute		1000	V~
F _c	mounting force with clip		50 - 250	N

Symbol	Conditions	Characteristic Values		
		min.	typ.	max.
R _{pin to chip} ¹⁾	L+ to L1/L2/L3 or L- to L1/L2/L3		0.9	mΩ
C _p	coupling capacity between shorted pins and back side metallization		160	pF
Weight			25	g

¹⁾ V_{DS} = I_D · (R_{DS(on)} + 2R_{Pin to Chip})

Recommended printed circuit board lay-out

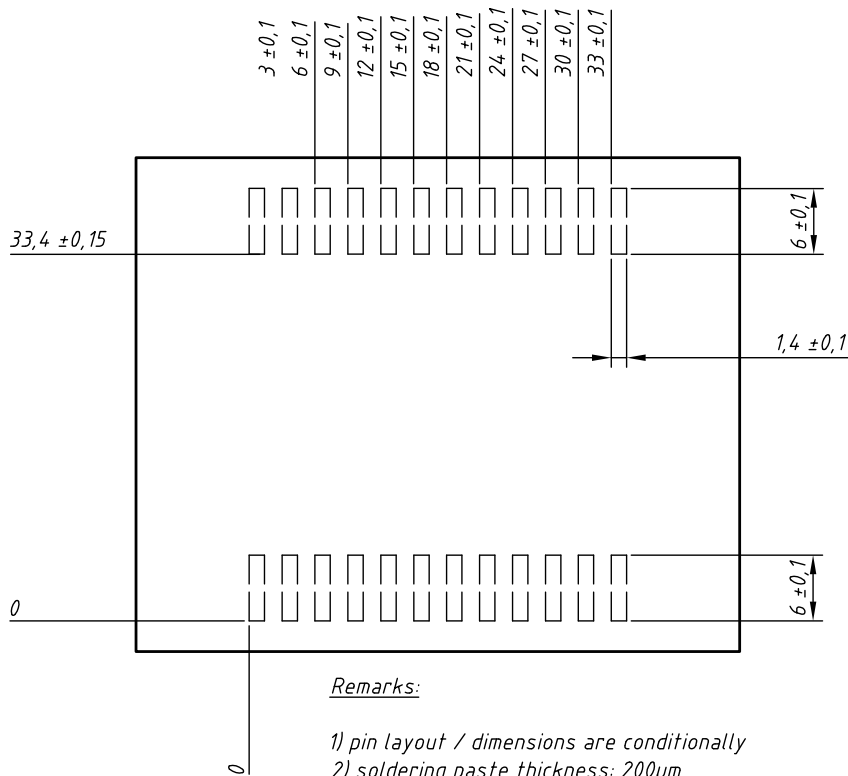

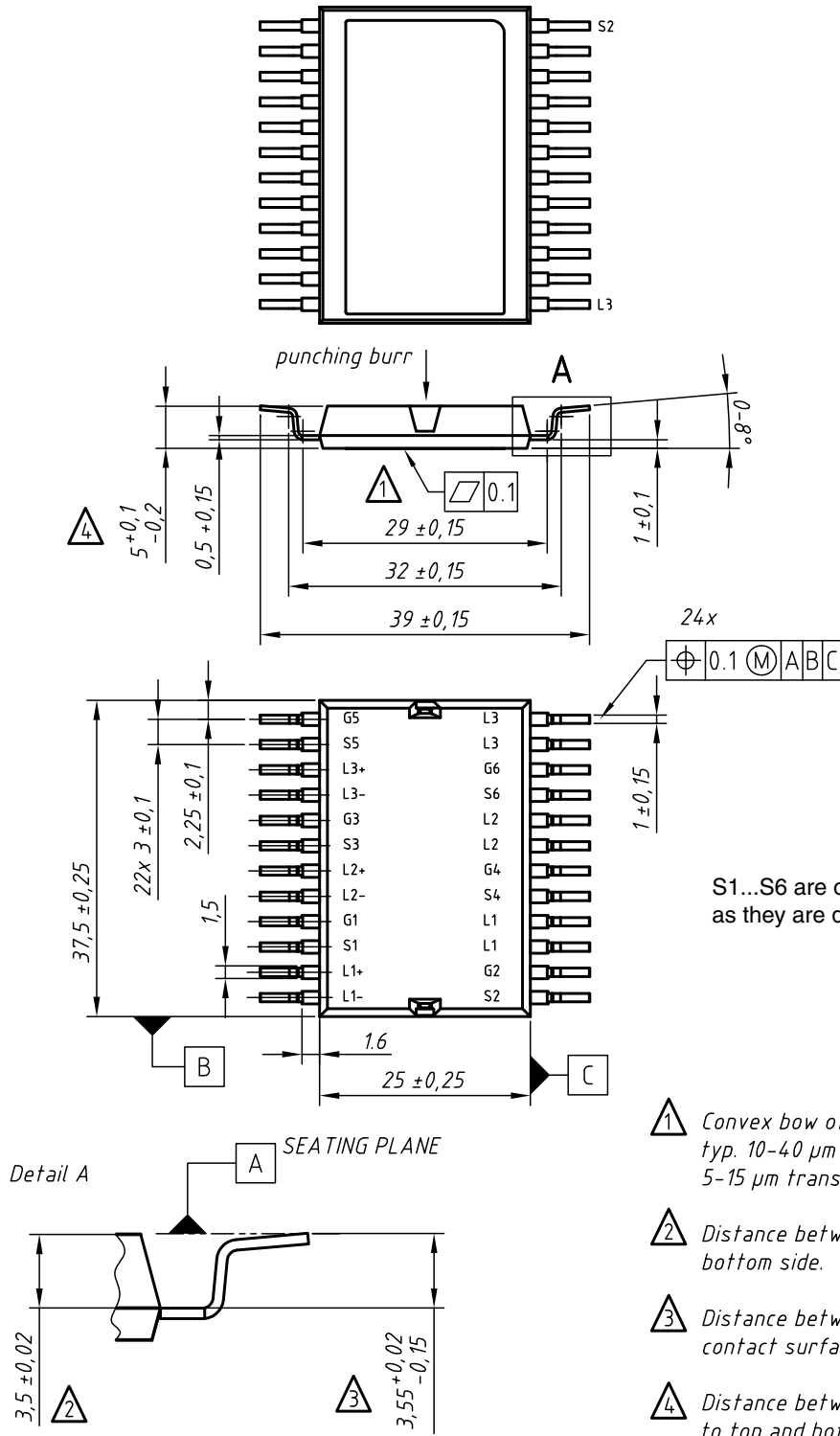

S1...S6 are only for the use of the gate drive as they are designed as Kelvin contacts

contact pin:

- galv. tin plating, per pin side: Sn 10...25 μ m, undercoating Ni 0,2...1 μ m
- stamping edges may be free of tin
- punching burr: $\leq 0,05$ mm

Leads	Ordering	Part Name & Packing Unit Marking	Part Marking	Delivering Mode	Base Qty.	Ordering Code
SMD	Standard	GMM 3x60-015X2 - SMD	GMM 3x60-015X2	Blister	28	510635

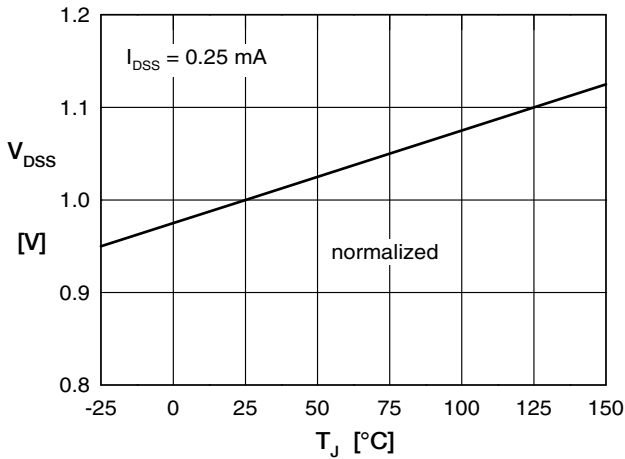

Fig. 1 Drain source breakdown voltage V_{DSS} vs. junction temperature T_{J}

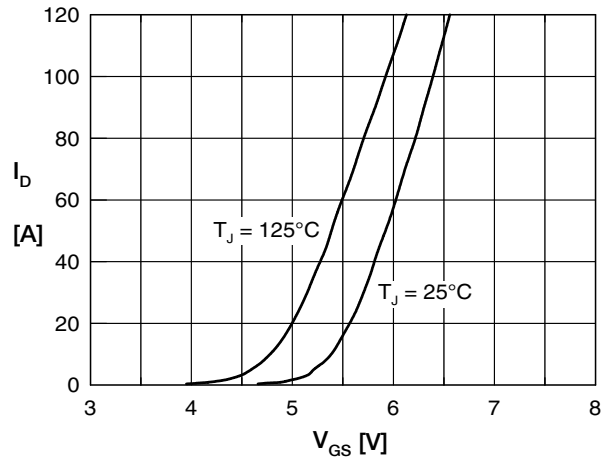

Fig. 2 Typ. transfer characteristics

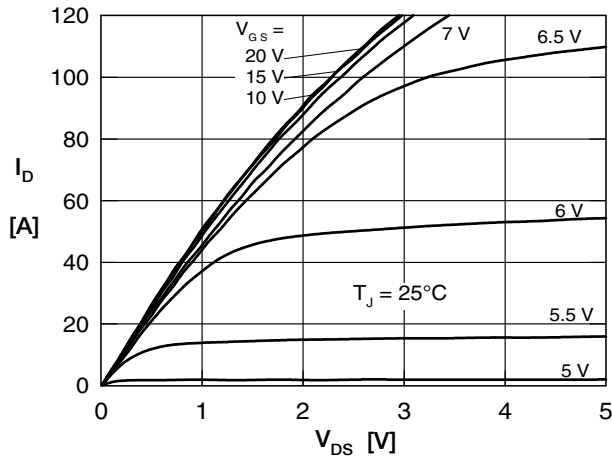

Fig. 3 Typ. output characteristics

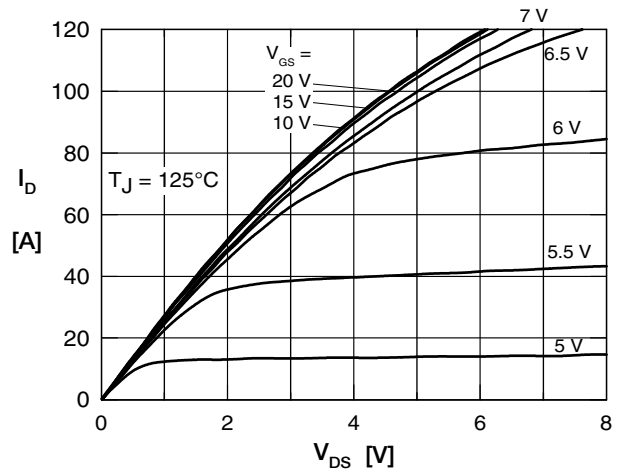

Fig. 4 Typ. output characteristics

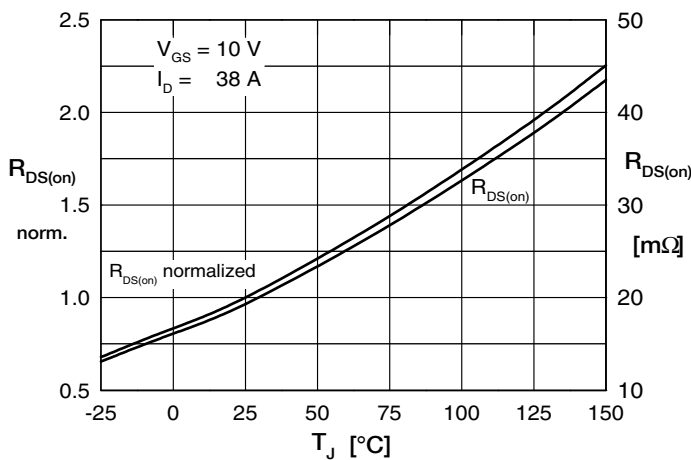

Fig. 5 Drain source on-state resistance $R_{DS(on)}$ versus junction temperature T_{J}

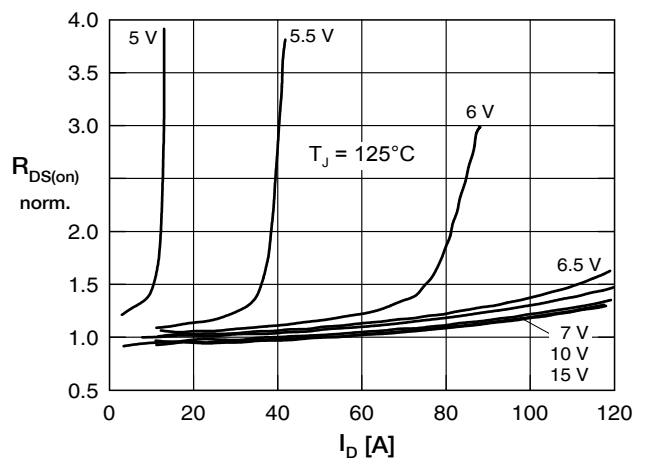

Fig. 6 Drain source on-state resistance $R_{DS(on)}$ versus I_D

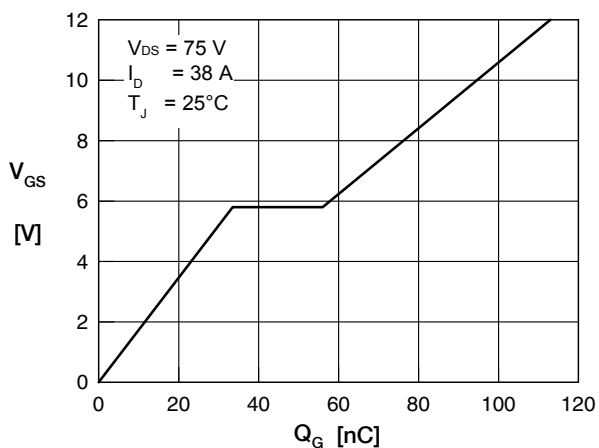

Fig. 7 Typical turn on gate charge

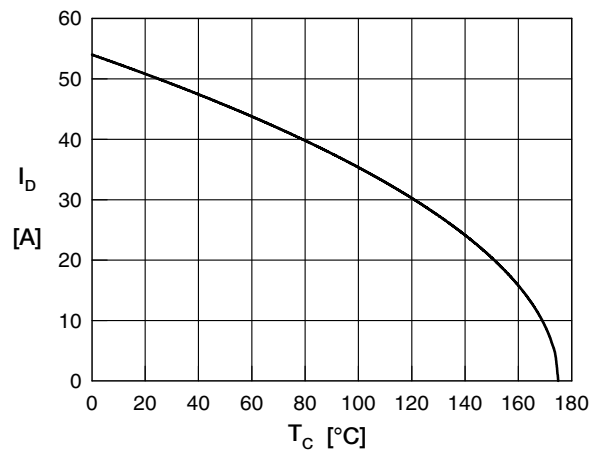
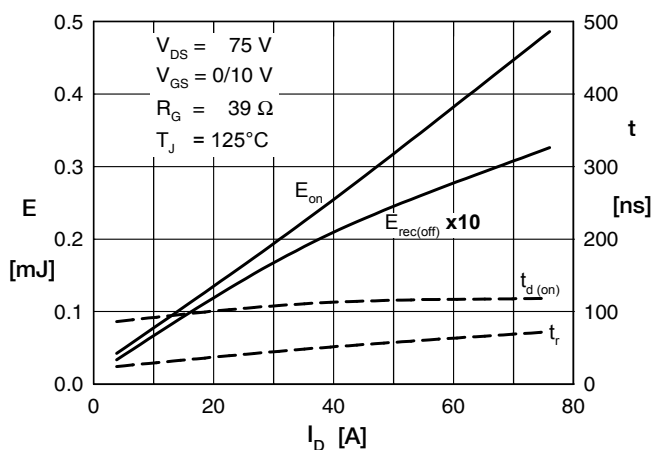

 Fig. 8 Drain current I_D vs. case temperature T_C

Fig. 9 Typ. turn-on energy and switching times versus drain current, inductive switching

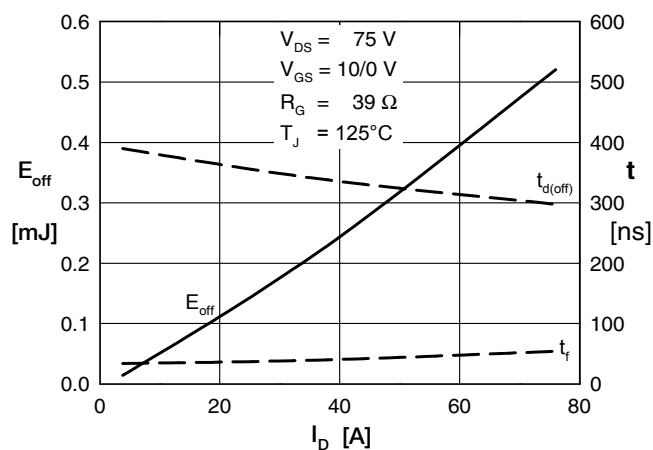

Fig. 10 Typ. turn-off energy and switching times versus drain-current, inductive switching

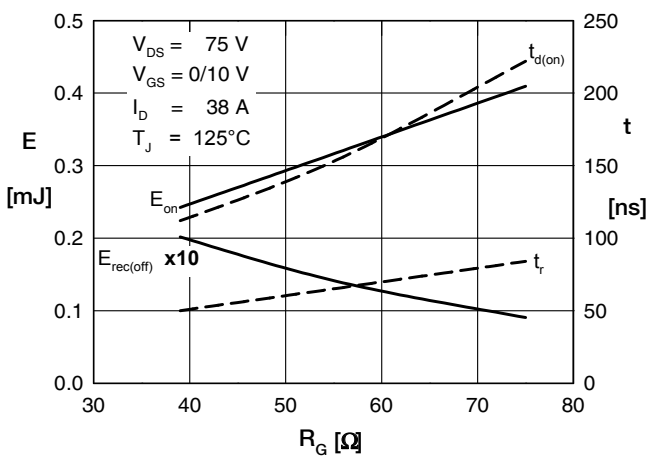

Fig. 11 Typ. turn-on energy and switching times versus gate resistor, inductive switching

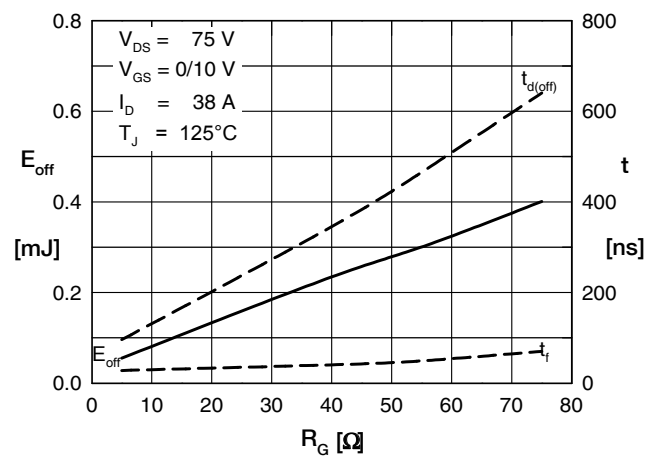

Fig. 12 Typ. turn-off energy and switching times versus gate resistor, inductive switching

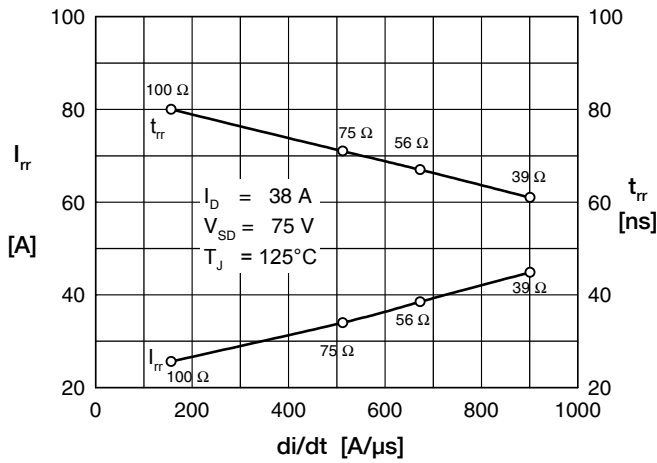

Fig. 13 Typ. reverse recovery characteristics

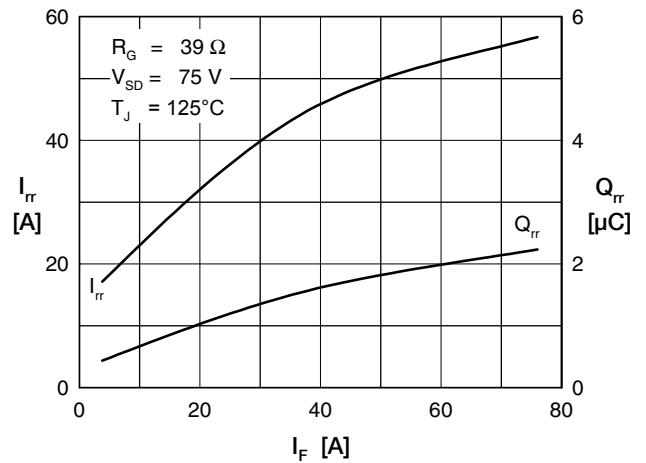

Fig. 14 Typ. reverse recovery characteristics

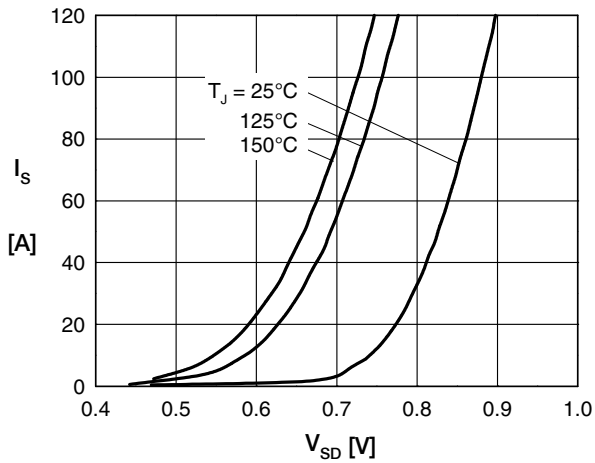

Fig. 15 Source current I_S versus source drain voltage V_{SD} (body diode)

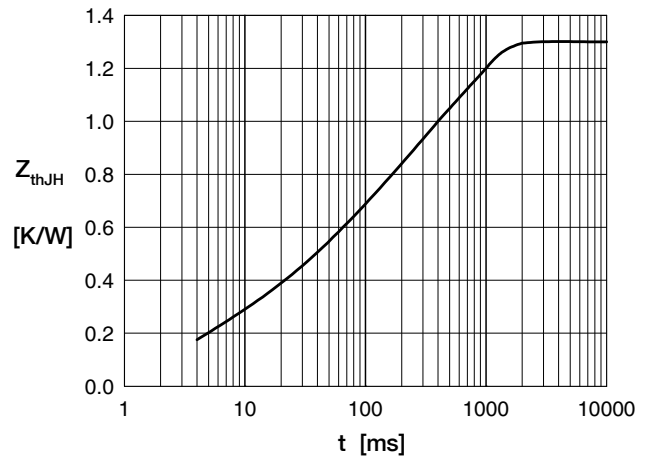

Fig. 16 Typ. thermal impedance junction to heatsink Z_{thJH} with heat transfer paste (IXYS test setup)

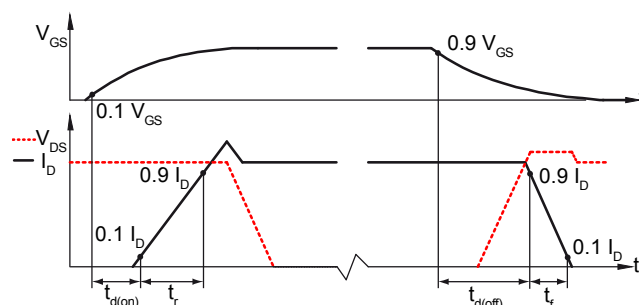

Fig. 17 Definition of switching times