

WizFi630 Quick Start Guide

(Version 1.1)



©2012 WIZnet Co., Ltd. All Rights Reserved.

☞ For more information, visit our website at <http://www.wiznet.co.kr>

Document Revision History

Date	Revision	Changes
2012-07-02	1.0	Release.
2012-07-05	1.1	Add link for serial command guide. Modify error sentence.

<Contents>

1. How to connect to administration web page	1
1.1. Configuration of WizFi630-EVB	1
1.2. Test Settings (H/W).....	1
1.3. Test Settings (S/W).....	2
1.4. Connection Check.....	3
1.5. Connecting the Web page of WizFi630.....	4
1.5.1. Web address.....	4
1.5.2. Web Login.....	4
2. Demonstration & Test	6
2.1. Serial to Wi-Fi Test 1 (AP Mode)	6
2.1.1. Environment for Serial to Wi-Fi Test	6
2.1.2. Setting WizFi630.....	7
2.1.3. <PC 2> Settings	8
2.1.4. Communication Test of WizFi630	9
2.2. Serial to Wi-Fi Test 2 (Client Mode).....	10
2.2.1. Environment for Serial to Wi-Fi Test	10
2.2.2. Setting WizFi630 < PC 1 >	11
2.2.3. <PC 2> Settings	14
2.2.4. Communication Test of WizFi630	15

1. How to connect to administration web page

This chapter will explain about the basic settings for connecting to the administration web page.

The content of this chapter is based on WizFi630-EVB for evaluation of WizFi630.

1.1. Configuration of WizFi630-EVB

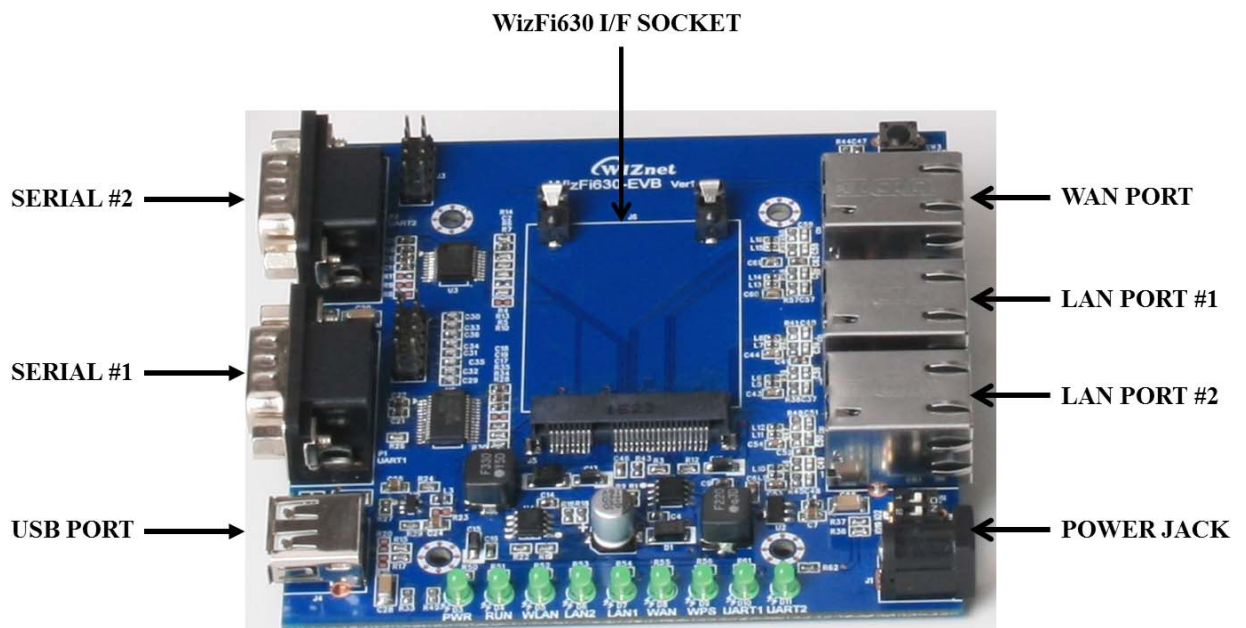

1.2. Test Settings (H/W)

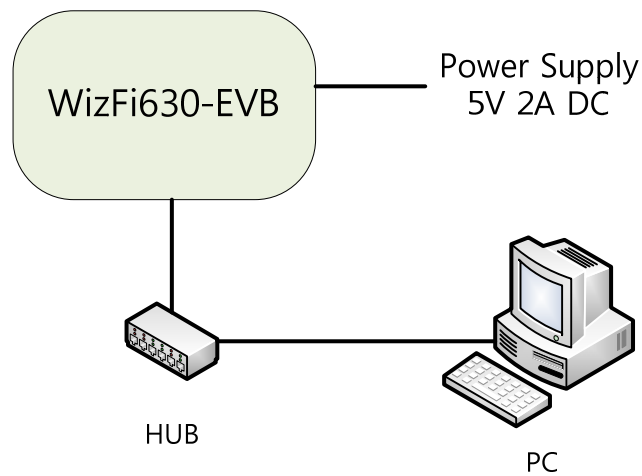

- ◆ Connect the WizFi630 module onto WizFi630-EVB.
- ◆ Connect a 5V, 2A Adapter and turn on the switch.

- ◆ Connect the Ethernet port of WizFi630-EVB with the hub.
- ◆ Connect the PC with the hub.

1.3. Test Settings (S/W)

Please use the following WizFi630 network setting for the user's PC network setting.

WizFi630	PC
IP Address: 192.168.16.254	IP Address: 192.168.16.XXX
Gateway: 192.168.16.1	Gateway: 192.168.16.1
Subnet: 255.255.255.0	Subnet: 255.255.255.0

- ◆ Open "Network Connections" from "Control Panel."
- ◆ Right click "Local Area Connection" and select "Properties."

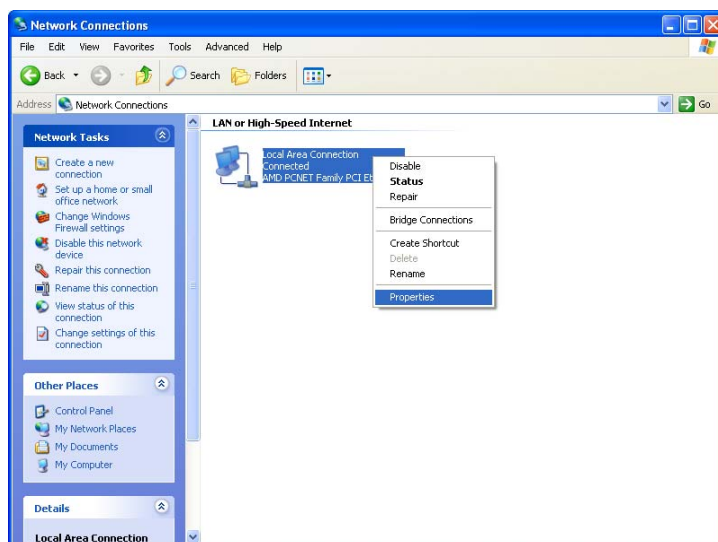

- ◆ Select "Internet Protocol(TCP/IP)" and click "Properties." Click "Advanced" at the new window.

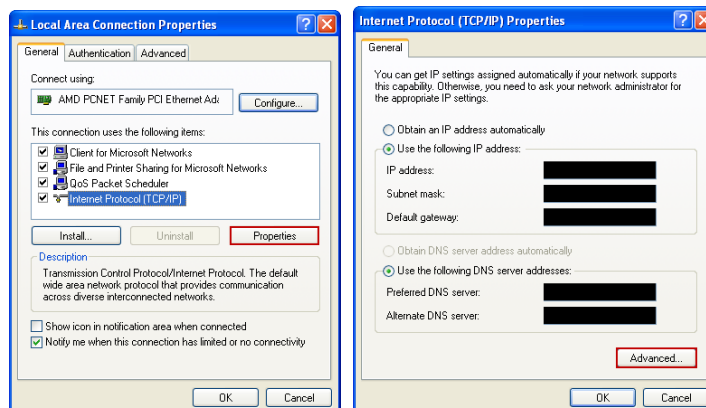

- ◆ Click "Add" in the "Advance TCP/IP Settings" window, and enter the IP address as 192.168.16.XXX and the subnet mask as 255.255.255.0 and click "Add" again.

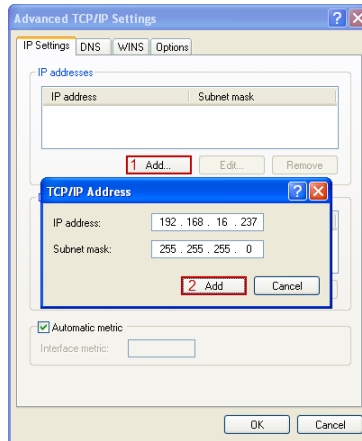

1.4. Connection Check

After the test setting is done, check the connection between WizFi630 and the PC using ping test.

- ◆ Click Start -> Run and enter cmd.

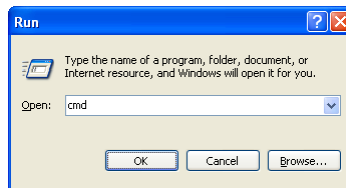

- ◆ Enter ping 192.168.16.254 when the CMD window opens.

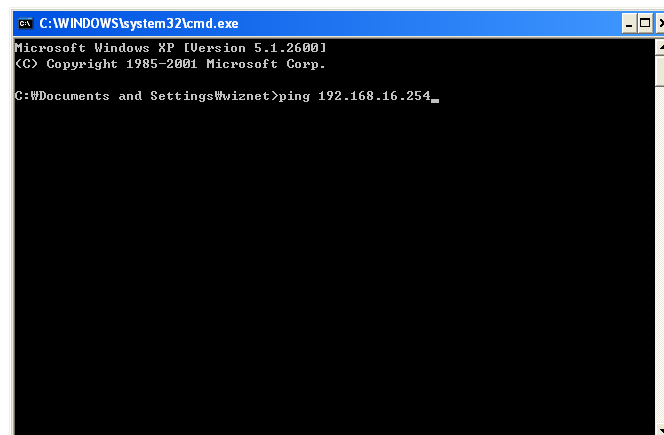

1.5. Connecting the Web page of WizFi630

- ◆ Some items may be not supported depending on the version.
- ◆ The following processes may vary depending on the user's version.

1.5.1. Web address

- ◆ Open a web browser on user's PC.
Input the default IP address of WizFi630, "192.168.16.254" and click Enter.



1.5.2. Web Login

- ◆ A pop up will request user to input User ID and Password
- ◆ User ID: admin / Password: admin

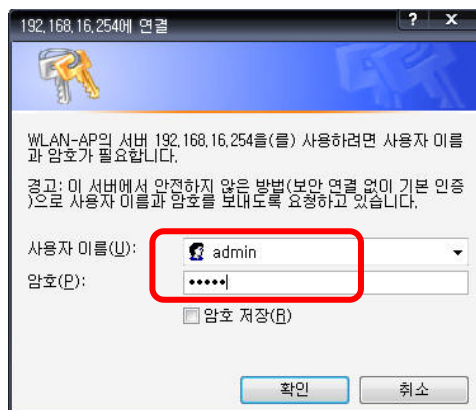

- ◆ The system's basic information, as shown below, will appear if successfully authenticated..

WLAN Gateway Module...

WLAN AP

- ▶ Operation Mode
- ▶ Internet Settings
- ▶ Wireless Settings
- ▶ Serial Setting
- ▶ Firewall
- ▶ Managements
- ▶ System Mgmt
- ▶ Firmware Mgmt
- ▶ Config Mgmt
- ▶ Port Mgmt
- ▶ Packet Statistics
- ▶ **System Status**
- ▶ System Log

It display system firmware version, up-time, operation mode and internet configuration and connection information.

System Status

System Information	
F/W Version	DS620P-11n-4M-usb-sta-PCle-msg_v1.1.22-2011/11/25, 20:08:46
System Up Time	2 days, 23 hours, 55 mins, 57 secs
Operation Mode	Gateway Mode
Wireless Driver Version	2.6.0.0
Internet Configurations	
Connected Type	DHCP
WAN IP Address	192.168.123.34
Subnet Mask	255.255.255.0
Default Gateway	192.168.123.254
Primary Domain Name Server	168.126.63.1
Secondary Domain Name Server	168.126.63.2
MAC Address	00:50:38:E0:00:0E

Type	Description
F/W Version	The firmware version of WizFi630 is displayed.
System Up Time	System up time displayed.
Operation Mode	System operation mode displayed.
Internet Configuration	Information of the external network is displayed.
Local Network	Information of the Local network is displayed.
Ethernet Port Status	Link of LAN Port status is displayed.

2. Demonstration & Test

This section will show examples of how to test WizFi630.

The operation modes will be AP mode and Client (Station) mode when testing WizFi630.

2.1. Serial to Wi-Fi Test 1 (AP Mode)

2.1.1. Environment for Serial to Wi-Fi Test

This section will explain on how to set Wizfi630 in AP mode and test Serial to Ethernet.

Connect WizFi630 and <PC1> with RS-232 and LAN cable as shown below; set the operation mode as AP mode, and start the TCP server.

Connect <PC2> with WizFi630 and communicate using TCP client program.

The communicated data can be checked from <PC1> serial terminal.

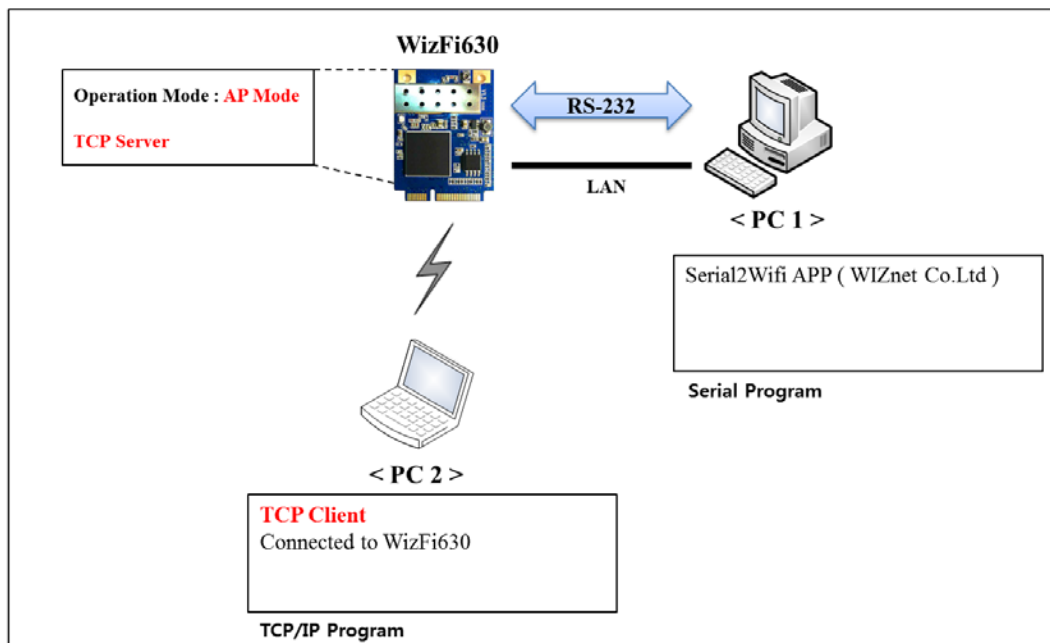

2.1.2. Setting WizFi630

1. Connect <PC1> and WizFi630.
2. Enter 192.168.16.254 in <PC1> web browser and connect to the administration web page.
(We recommend directly connecting <PC1> and WizFi630 instead of using hub).
3. Check the operation mode of WizFi630; select AP mode in case of other mode is being used.

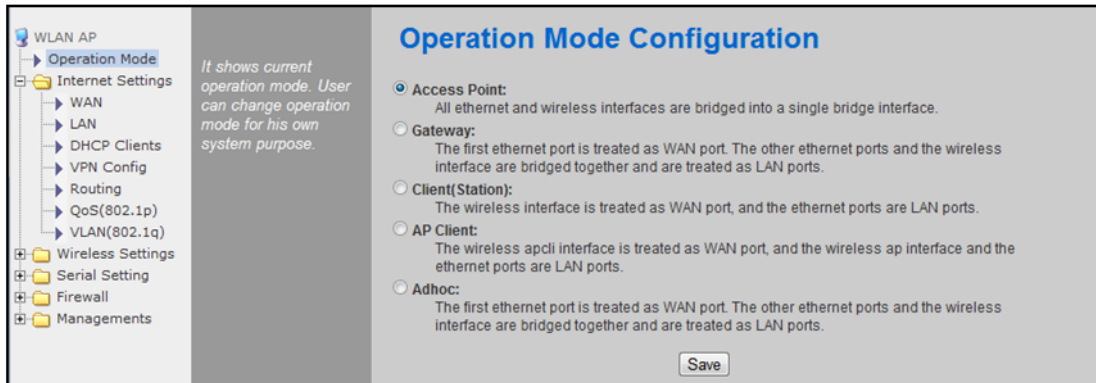

4. Set the serial settings of the WizFi630 to TCP server as shown below.
(Check the Server Port, Baud rate, Data bits, Parity, Stop bits, and Flow control)

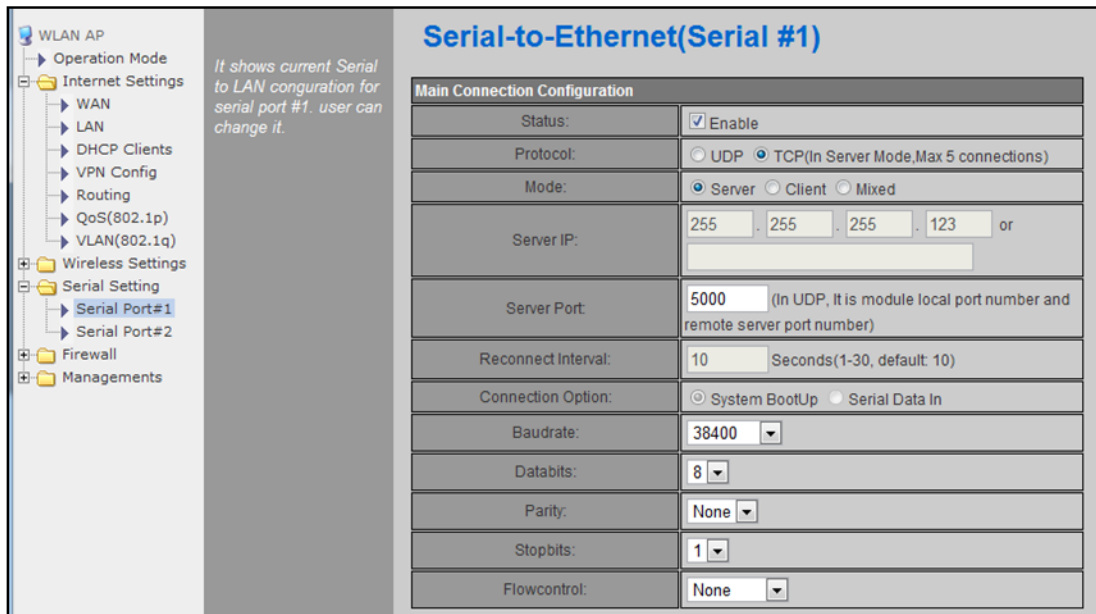

2.1.3. <PC 2> Settings

1. Connect the network for WizFi630 < Default SSID : WLAN-AP >

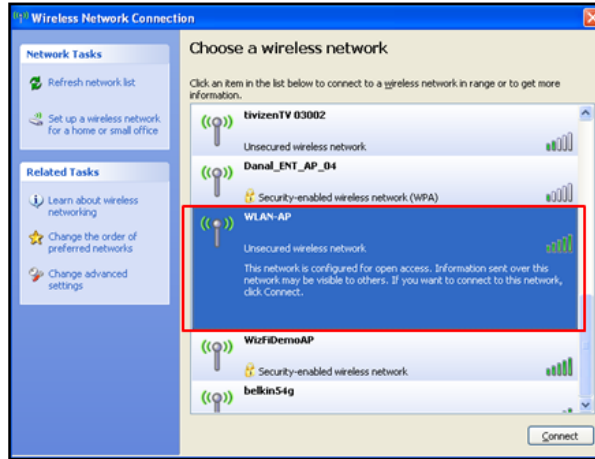

2. Retrieve the IP address of WizFi630 and ping test.
If the ping test is successful, the network is connected.

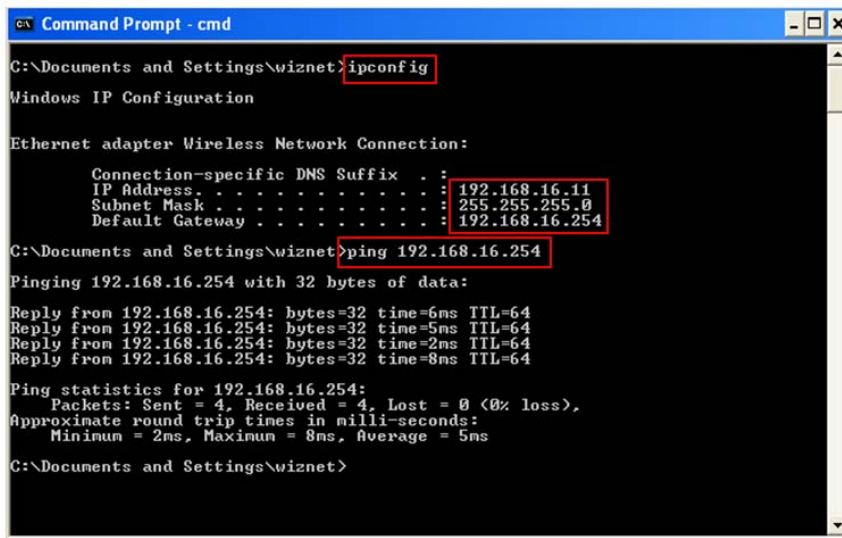

2.1.4. Communication Test of WizFi630

1. Open <PC1>'s serial program, enter the serial configuration value, and click 'open.'
< Serial Program: Device Terminal Ver. 1.0 >
2. Open <PC2>'s TCP/IP program, enter the IP address of the TCP server (192.168.16.254), and click 'connect.' < TCP/IP Program : Device Terminal Ver. 1.0 >
3. Check the data communication using <PC1>'s serial program and <PC2>'s TCP/IP program.

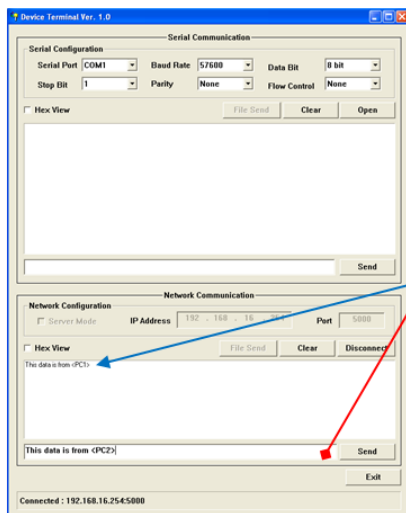
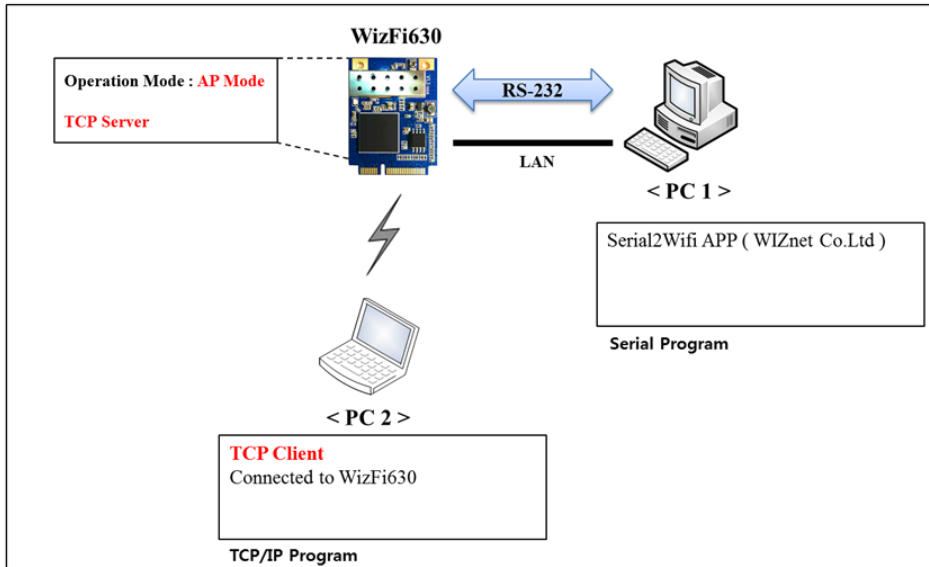

<PC 2> TCP/IP Program

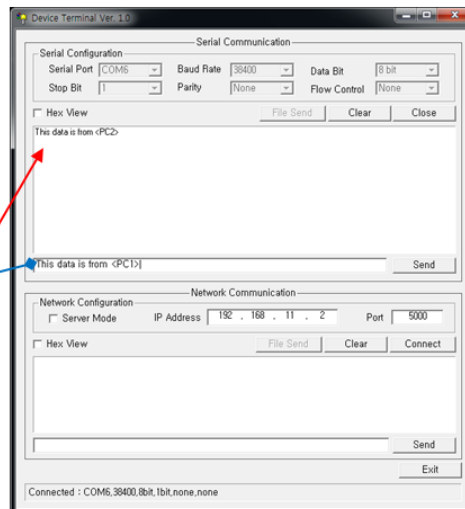

<PC 1> Serial Program

2.2. Serial to Wi-Fi Test 2 (Client Mode)

2.2.1. Environment for Serial to Wi-Fi Test

This section will explain on how to set WizFi630 in client mode and test Serial to Ethernet.

Connect WizFi630 and <PC1> with RS-232 and LAN cable as shown below; set the operation mode as Client mode, and start the TCP server.

Connect <PC2> with WizFi630 and communicate using TCP client program.

The communicated data can be checked from <PC1> serial terminal.

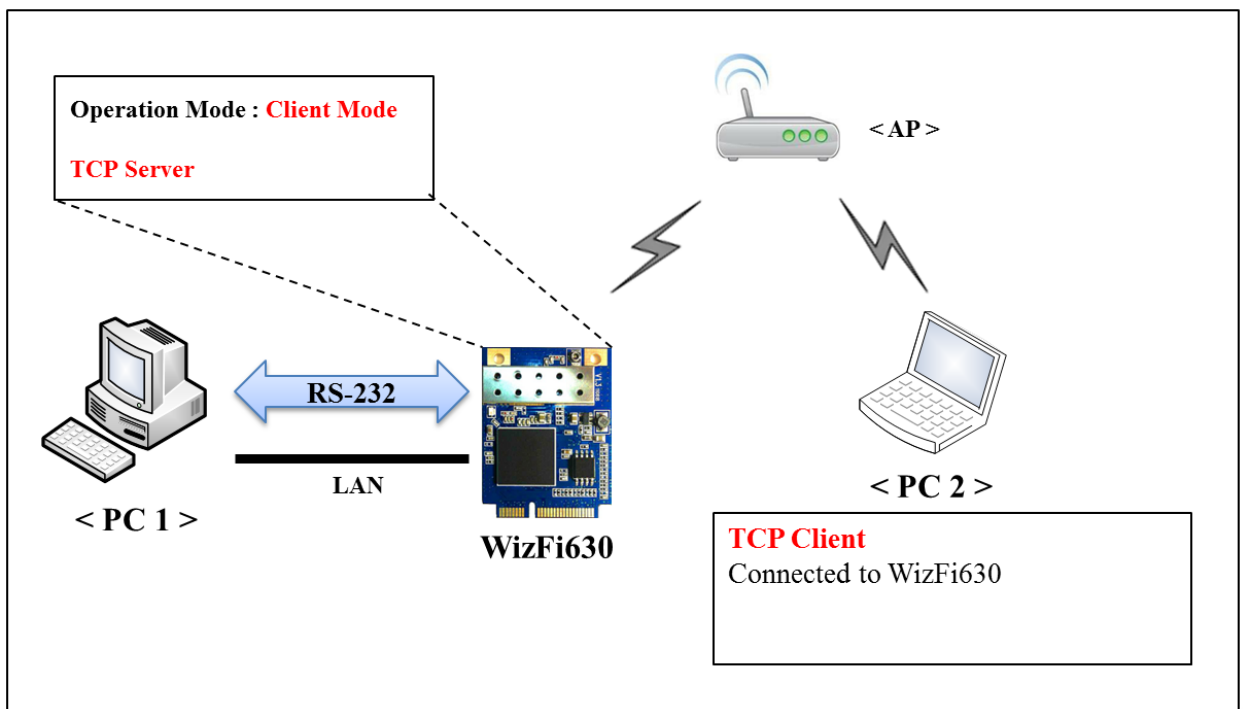

2.2.2. Setting WizFi630 < PC 1 >

1. Connect <PC1> and WizFi630 with serial cable and LAN cable.
2. Once serial connection is established with WizFi630, check the IP address with <R1> command.

※ Please refer to the WIZSmartScript including WizFi630 Serial Command Guide (<http://www.wiznet.co.kr/WizFi630/download>)

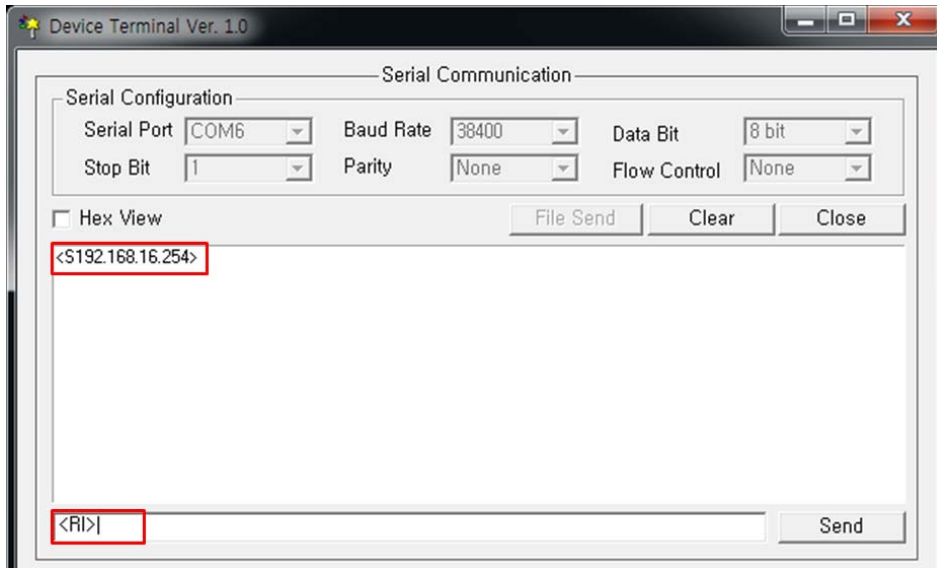

3. Enter 192.168.16.254 in <PC1> web browser and connect to the administration web page. (We recommend directly connecting <PC1> and WizFi630 instead of using hub).
4. Check the operation mode of WizFi630; select Client (Station) mode in case of other mode is being used.

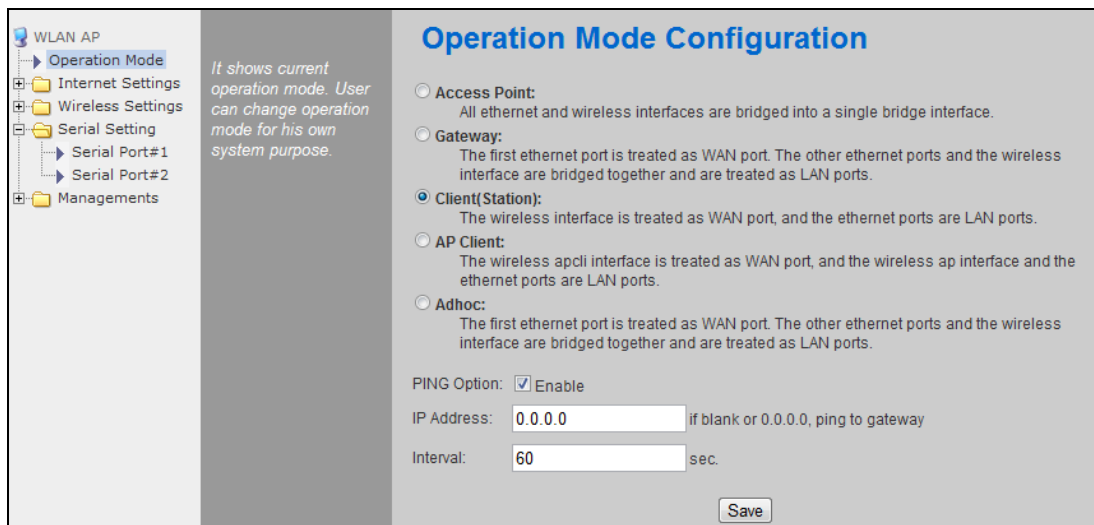

5. Attempt connection with surrounding AP in the Station Site Survey menu.

< SSID : belkin54g >

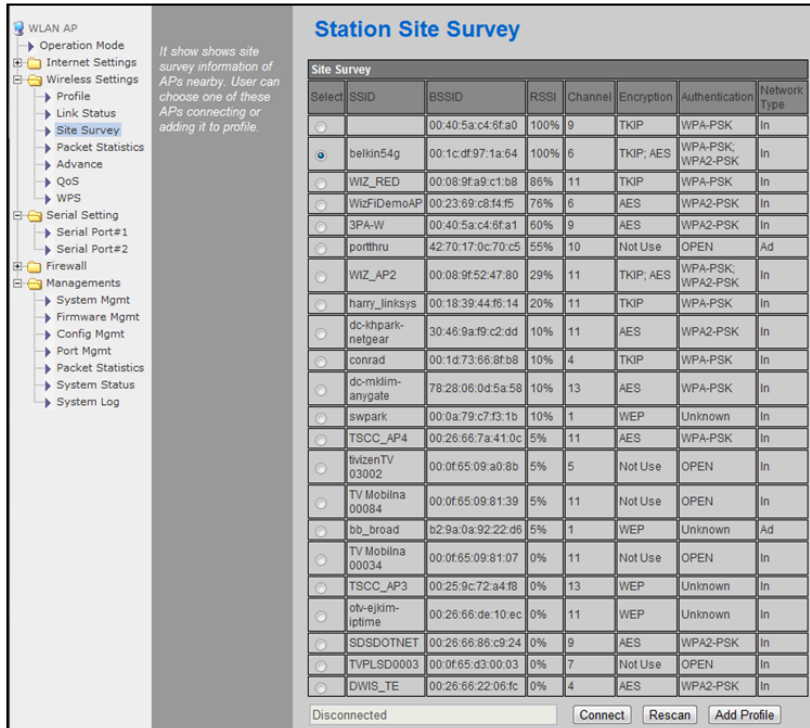

Station Site Survey

It show shows site survey information of APs nearby. User can choose one of these APs connecting or adding it to profile.

Select	SSID	BSSID	RSSI	Channel	Encryption	Authentication	Network Type
<input type="radio"/>		00:40:5a:c4:6f:a0	100%	9	TKIP	WPA-PSK	In
<input checked="" type="radio"/>	belkin54g	00:1c:df:97:1a:84	100%	6	TKIP, AES	WPA-PSK, WPA2-PSK	In
<input type="radio"/>	WIZ_RED	00:08:9f:a9:c1:b8	86%	11	TKIP	WPA-PSK	In
<input type="radio"/>	WizFiDemoAP	00:23:69:c8:14:f5	76%	6	AES	WPA2-PSK	In
<input type="radio"/>	3PA-W	00:40:5a:c4:6f:a1	60%	9	AES	WPA2-PSK	In
<input type="radio"/>	portthru	42:70:17:0c:70:c5	55%	10	Not Use	OPEN	Ad
<input type="radio"/>	WIZ_AP2	00:08:9f:52:47:80	29%	11	TKIP, AES	WPA-PSK, WPA2-PSK	In
<input type="radio"/>	harry_linksys	00:18:39:44:f6:14	20%	11	TKIP	WPA-PSK	In
<input type="radio"/>	dc-khpark-netgear	30:46:9a:f9:c2:dd	10%	11	AES	WPA2-PSK	In
<input type="radio"/>	conrad	00:1d:73:66:8f:b8	10%	4	TKIP	WPA-PSK	In
<input type="radio"/>	dc-mklim-anygate	78:28:06:0d:5a:58	10%	13	AES	WPA-PSK	In
<input type="radio"/>	swpark	00:0a:79:c7:f3:1b	10%	1	WEP	Unknown	In
<input type="radio"/>	TSCC_AP4	00:26:66:7a:41:0c	5%	11	AES	WPA-PSK	In
<input type="radio"/>	livizenTV 03002	00:0f:65:09:a0:8b	5%	5	Not Use	OPEN	In
<input type="radio"/>	TV Mobilna 00084	00:0f:65:09:81:39	5%	11	Not Use	OPEN	In
<input type="radio"/>	bb_broad	b2:9a:0a:92:22:d6	5%	1	WEP	Unknown	Ad
<input type="radio"/>	TV Mobilna 00034	00:0f:65:09:81:07	0%	11	Not Use	OPEN	In
<input type="radio"/>	TSCC_AP3	00:25:9c:72:a4:f8	0%	13	WEP	Unknown	In
<input type="radio"/>	olv-ejkim-iptime	00:26:66:de:10:ec	0%	11	WEP	Unknown	In
<input type="radio"/>	SDSDOTNET	00:26:66:88:c9:24	0%	9	AES	WPA2-PSK	In
<input type="radio"/>	TVPLSD0003	00:0f:65:d3:00:03	0%	7	Not Use	OPEN	In
<input type="radio"/>	DWIS_TE	00:26:66:22:06:fc	0%	4	AES	WPA2-PSK	In

Disconnected Connect Rescan Add Profile

- The WAN IP address below is the IP address assigned from AP.

It displays system firmware version, up-time, operation mode and internet configuration and connection information.

System Status

System Information	
FW Version	DS620P-11n-4M-usb-sta-PCle_v1.1.24-2012/06/01, 20.04.53
System Up Time	1 hour, 40 mins, 55 secs
Operation Mode	Client Mode
Wireless Driver Version	2.5.0.0
Internet Configurations	
Connected Type	DHCP
WAN IP Address	192.168.1.7
Subnet Mask	255.255.255.0
Default Gateway	192.168.1.1
Primary Domain Name Server	192.168.1.1
Secondary Domain Name Server	8.8.8.8
MAC Address	00:50:38:08:38:B8
Local Network	
Local IP Address	192.168.16.254
Local Netmask	255.255.255.0
MAC Address	00:50:38:08:38:B9
Ethernet Port Status	<input type="checkbox"/> <input type="checkbox"/> <input checked="" type="checkbox"/> <input type="checkbox"/> <input type="checkbox"/>

Refresh

- Set the serial settings for WizFi630 to TCP server as shown below.
(Check the Server Port, Baud rate, Data bits, Parity, Stop bits, and Flow control)

It shows current Serial to LAN conugration for serial port #1. user can change it.

Serial-to-Ethernet(Serial #1)

Main Connection Configuration	
Status:	<input checked="" type="checkbox"/> Enable
Protocol:	<input type="radio"/> UDP <input checked="" type="radio"/> TCP(In Server Mode,Max 5 connections)
Mode:	<input checked="" type="radio"/> Server <input type="radio"/> Client <input type="radio"/> Mixed
Server IP:	255 . 255 . 255 . 123 or
Server Port:	5000 (In UDP, It is module local port number and remote server port number)
Reconnect Interval:	10 Seconds(1-30, default: 10)
Connection Option:	<input type="radio"/> System BootUp <input type="radio"/> Serial Data In
Baudrate:	38400
Databits:	8
Parity:	None
Stopbits:	1
Flowcontrol:	None

2.2.3. <PC 2> Settings

1. Connect to AP. < Ex) belkin54g >

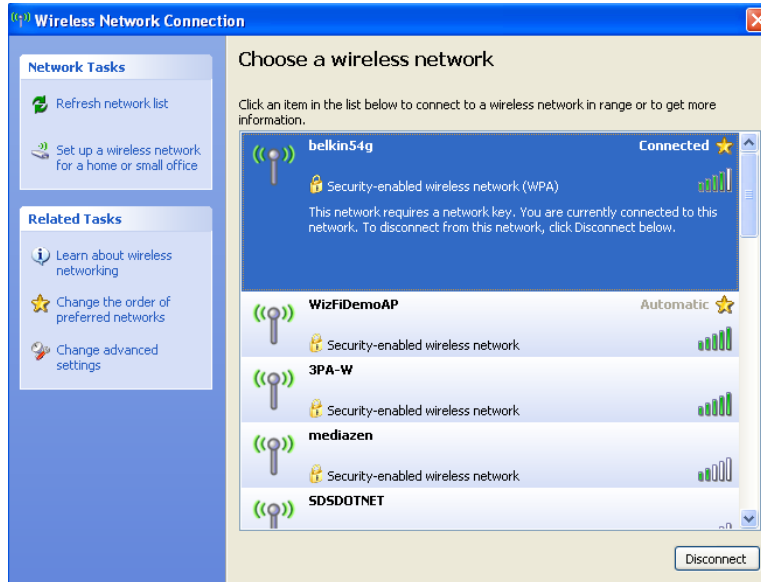

2. Retrieve the IP address of WizFi630 and ping test.
If the ping test is successful, the network is connected.
(WizFi630's IP Address : 192.168.1.7)

```

C:\WINDOWS\system32\cmd.exe
C:\Documents and Settings\wiznet>ipconfig
Windows IP Configuration

Ethernet adapter Wireless Network Connection:

    Connection-specific DNS Suffix  . : Belkin
    IP Address . . . . . : 192.168.1.6
    Subnet Mask . . . . . : 255.255.255.0
    Default Gateway . . . . . : 192.168.1.1

C:\Documents and Settings\wiznet>ping 192.168.1.7
Pinging 192.168.1.7 with 32 bytes of data:
Reply from 192.168.1.7: bytes=32 time=990ms TTL=64
Reply from 192.168.1.7: bytes=32 time=4ms TTL=64
Reply from 192.168.1.7: bytes=32 time=6ms TTL=64
Reply from 192.168.1.7: bytes=32 time=9ms TTL=64

Ping statistics for 192.168.1.7:
    Packets: Sent = 4, Received = 4, Lost = 0 (0% loss),
    Approximate round trip times in milli-seconds:
        Minimum = 4ms, Maximum = 990ms, Average = 252ms

C:\Documents and Settings\wiznet>
  
```

2.2.4. Communication Test of WizFi630

1. Open <PC1>'s serial program, enter the serial configuration value, and click 'open.'
< Serial Program : Device Terminal Ver. 1.0 >
2. Open <PC2>'s TCP/IP program, enter the IP address of the TCP server (192.168.1.7), and click 'connect.'
< TCP/IP Program : Device Terminal Ver. 1.0 >
3. Check the data communication using <PC1>'s serial program and <PC2>'s TCP/IP program.

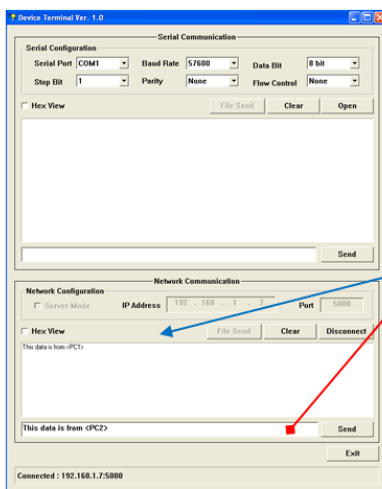
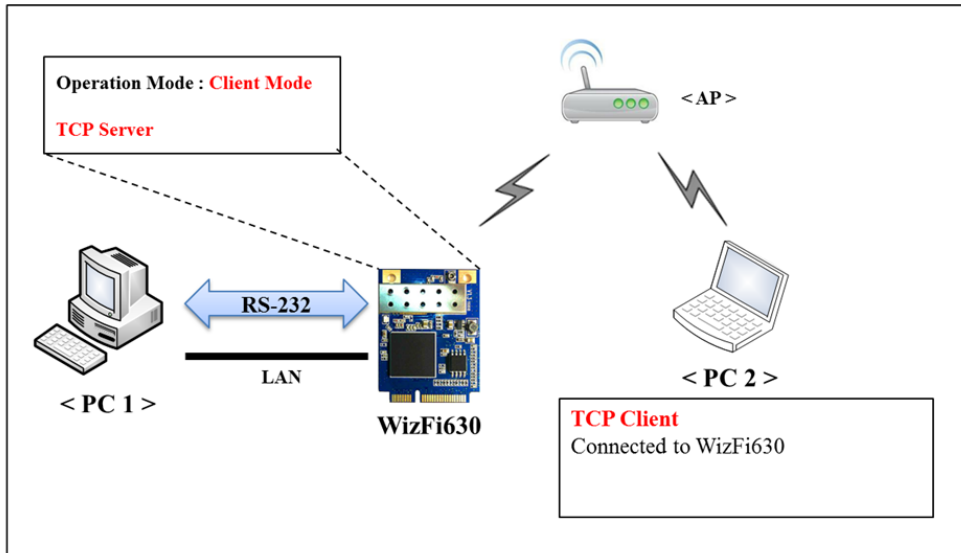

<PC 2> TCP/IP Program

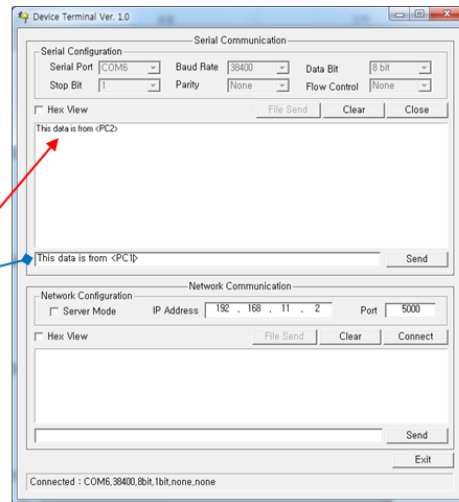

<PC 1> Serial Program