

# Infrared Emitter (940 nm) in Mini Sidelooker Package Version 1.2

## SFH 4141



### Features:

- Wavelength 950nm
- Narrow half angle  $\pm 9^\circ$
- Short switching times
- Small outline dimensions
- Same package as phototransistor SFH 3100 F
- High coupling factor in light barriers with SFH 3100 F

### Applications

- Discrete interrupters
- Data transmission
- Position sensing
- Barcode reader
- For control and drive circuits

### Notes

Depending on the mode of operation, these devices emit highly concentrated non visible infrared light which can be hazardous to the human eye. Products which incorporate these devices have to follow the safety precautions given in IEC 60825-1 and IEC 62471.

### Ordering Information

Type:	Radiant Intensity $I_e$ [mW/sr] $I_F = 20 \text{ mA}, t_p = 20 \text{ ms}$	Ordering Code
SFH 4141	35 ( $\geq 16$ )	Q65111A6138

Note: Measured at a solid angle of  $\Omega = 0.01 \text{ sr}$

**Maximum Ratings** ( $T_A = 25\text{ °C}$ )

Parameter	Symbol	Values	Unit
Operation and storage temperature range	$T_{op}; T_{stg}$	-40 ... 85	°C
Reverse voltage	$V_R$	5	V
Forward current	$I_F$	60	mA
Surge current ( $t_p \leq 100\ \mu\text{s}$ , $D = 0$ )	$I_{FSM}$	1	A
Power consumption	$P_{tot}$	100	mW
ESD withstand voltage (acc. to ANSI/ ESDA/ JEDEC JS-001 - HBM)	$V_{ESD}$	2	kV
Thermal resistance junction - ambient <sup>1) page 8</sup>	$R_{thJA}$	350	K / W
Thermal resistance junction - soldering point	$R_{thJS}$	200	K / W

**Characteristics** ( $T_A = 25\text{ °C}$ )

Parameter		Symbol	Values	Unit
Peak wavelength ( $I_F = 20\text{ mA}$ , $t_p = 20\text{ ms}$ )	(typ)	$\lambda_{peak}$	950	nm
Centroid wavelength ( $I_F = 20\text{ mA}$ , $t_p = 20\text{ ms}$ )	(typ)	$\lambda_{centroid}$	940	nm
Spectral bandwidth at 50% of $I_{max}$ ( $I_F = 20\text{ mA}$ , $t_p = 20\text{ ms}$ )	(typ)	$\Delta\lambda$	42	nm
Half angle	(typ)	$\varphi$	$\pm 9$	°
Dimensions of active chip area	(typ)	L x W	0.3 x 0.3	mm x mm
Rise and fall time of $I_e$ ( 10% and 90% of $I_{e\ max}$ ) ( $I_F = 20\text{ mA}$ , $R_L = 50\ \Omega$ )	(typ)	$t_r, t_f$	12	ns
Forward voltage ( $I_F = 20\text{ mA}$ , $t_p = 20\text{ ms}$ )	(typ (max))	$V_F$	1.3 ( $\leq 1.6$ )	V
Forward voltage ( $I_F = 1\text{ A}$ , $t_p = 100\ \mu\text{s}$ )	(typ (max))	$V_F$	3.6 ( $\leq 4.6$ )	V
Reverse current		$I_R$	not designed for reverse operation	$\mu\text{A}$
Total radiant flux ( $I_F = 20\text{ mA}$ , $t_p = 20\text{ ms}$ )	(typ)	$\Phi_e$	12	mW

Parameter		Symbol	Values	Unit
Temperature coefficient of $I_e$ or $\Phi_e$ ( $I_F = 20$ mA, $t_p = 20$ ms)	(typ)	$TC_I$	-0.3	% / K
Temperature coefficient of $V_F$ ( $I_F = 20$ mA, $t_p = 20$ ms)	(typ)	$TC_V$	-0.8	mV / K
Temperature coefficient of wavelength ( $I_F = 20$ mA, $t_p = 20$ ms)	(typ)	$TC_\lambda$	0.3	nm / K

Grouping ( $T_A = 25$  °C)

Group	Min Radiant Intensity $I_F = 20$ mA, $t_p = 20$ ms $I_{e, \min}$ [mW / sr]	Max Radiant Intensity $I_F = 20$ mA, $t_p = 20$ ms $I_{e, \max}$ [mW / sr]	Typ Radiant Intensity $I_F = 1$ A, $t_p = 100$ $\mu$ s $I_{e, \text{typ}}$ [mW / sr]
	SFH 4141-S	16	32
SFH 4141-T	25	50	410
SFH 4141-U	40	80	660

Note: measured at a solid angle of  $\Omega = 0.01$  sr

Only one group in one packing unit (variation lower 2:1).

Relative Spectral Emission <sup>2) page 8</sup>

$$I_{\text{rel}} = f(\lambda), T_A = 25^\circ\text{C}$$

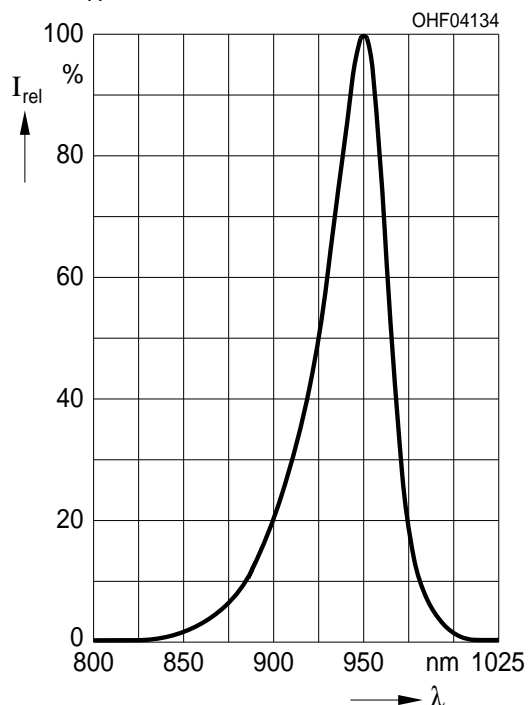
Radiant Intensity <sup>2) page 8</sup>

$$I_e / I_e(20 \text{ mA}) = f(I_F), \text{ single pulse, } t_p = 100 \mu\text{s}, T_A = 25^\circ\text{C}$$

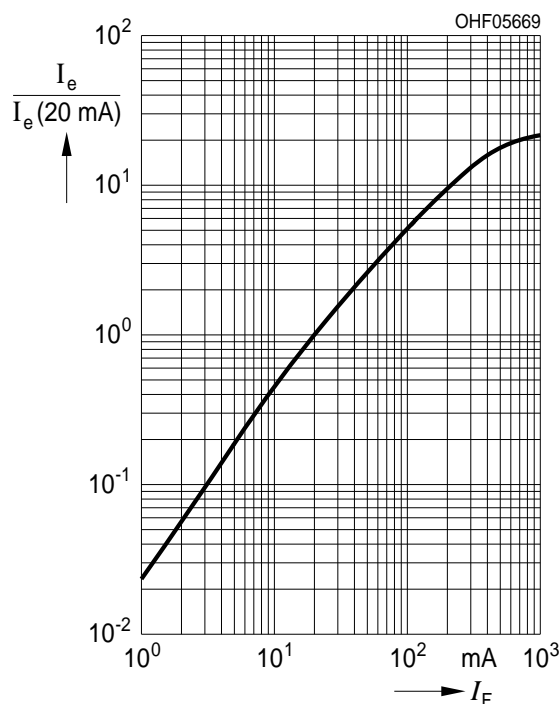

**Max. Permissible Forward Current**

$I_{F, \max} = f(T_A), R_{thJA} = 350 \text{ K / W}$

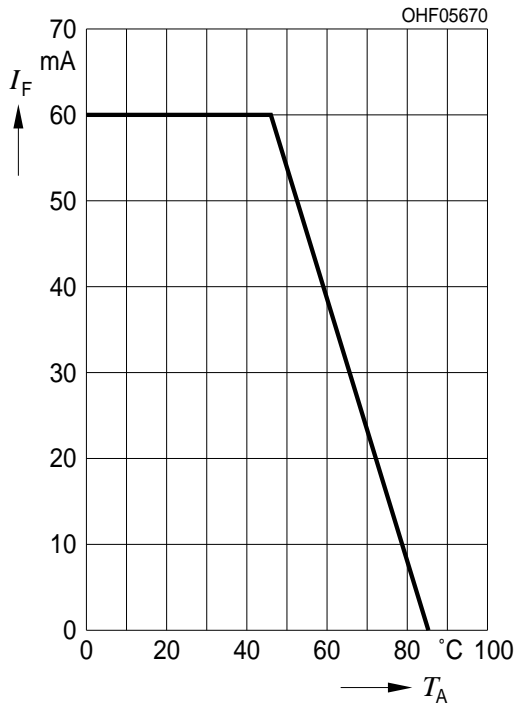

**Forward Current** <sup>2) page 8</sup>

$I_F = f(V_F), \text{ single pulse, } t_p = 100 \mu\text{s}, T_A = 25^\circ\text{C}$

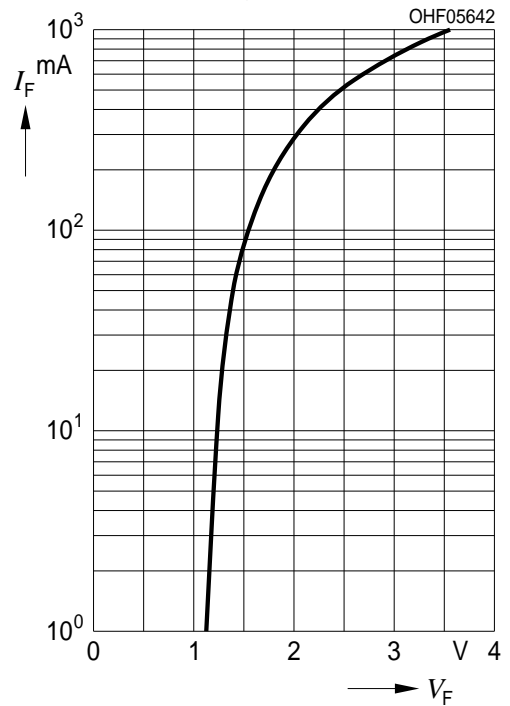

**Permissible Pulse Handling Capability**

$I_F = f(t_p), T_A = 25^\circ\text{C}, \text{ duty cycle } D = \text{parameter}$

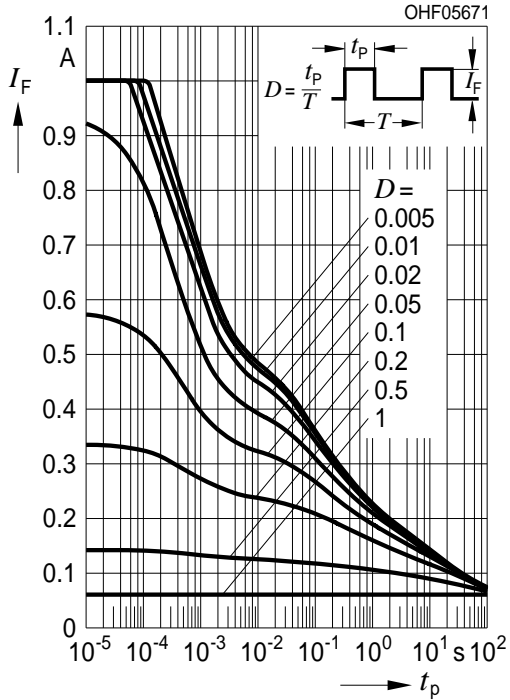

**Radiation Characteristics** <sup>2) page 8</sup>

$I_{rel} = f(\phi), T_A = 25^\circ C$

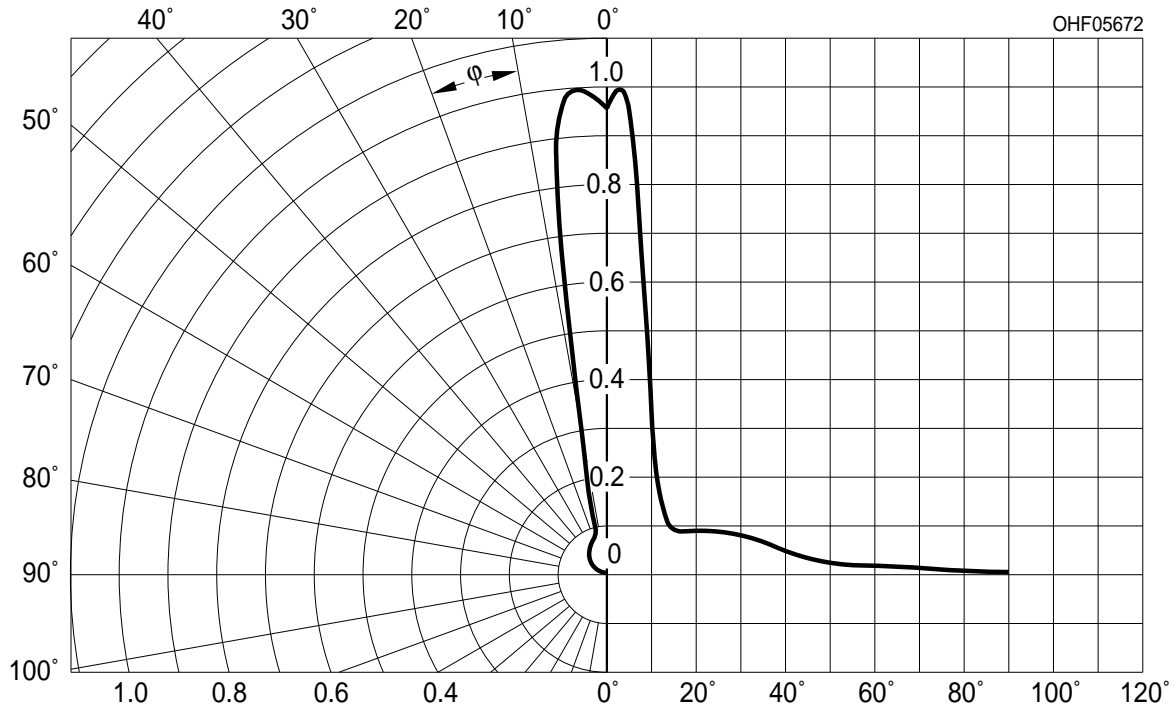

**Package Outline**

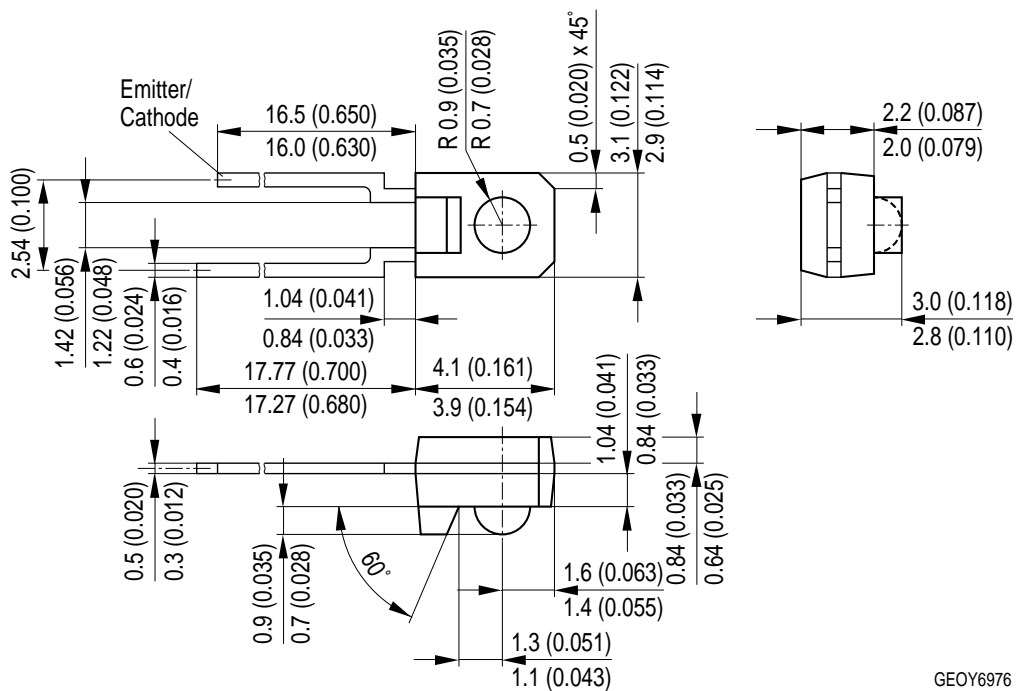

*Dimensions in mm (inch).*

**Package**

Miniature Sidelooker, clear resin

**Approximate Weight:**  
60.0 mg

**Recommended Solder Pad**

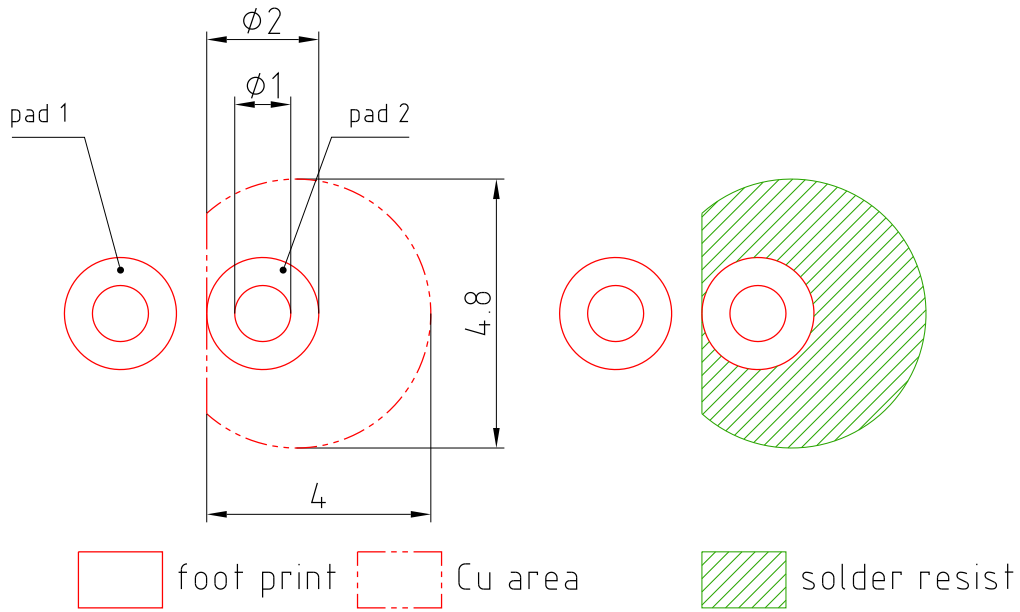

Dimensions in mm.

E062.3010.188-01

**Note:**  
pad 1: cathode

**TTW Soldering**

IEC-61760-1 TTW

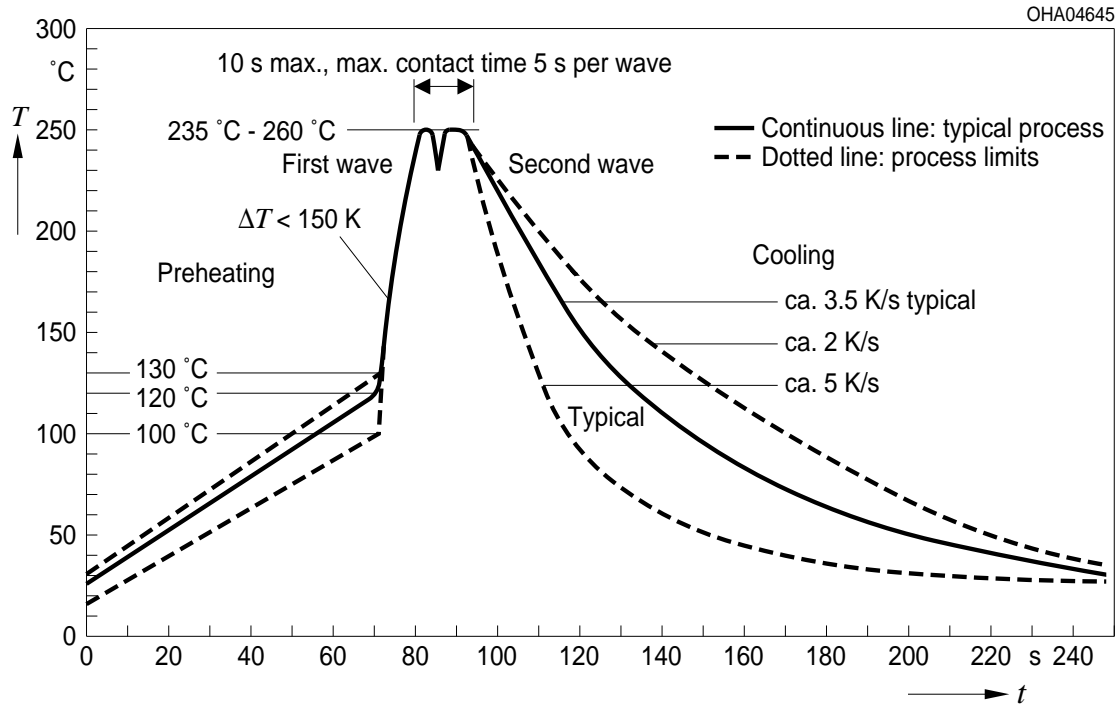
**Disclaimer**

Language english will prevail in case of any discrepancies or deviations between the two language wordings.

**Attention please!**

The information describes the type of component and shall not be considered as assured characteristics.

Terms of delivery and rights to change design reserved. Due to technical requirements components may contain dangerous substances.

For information on the types in question please contact our Sales Organization.

If printed or downloaded, please find the latest version in the Internet.

**Packing**

Please use the recycling operators known to you. We can also help you – get in touch with your nearest sales office. By agreement we will take packing material back, if it is sorted. You must bear the costs of transport. For packing material that is returned to us unsorted or which we are not obliged to accept, we shall have to invoice you for any costs incurred.

**Components used in life-support devices or systems must be expressly authorized for such purpose!**

Critical components\* may only be used in life-support devices\*\* or systems with the express written approval of OSRAM OS.

\*) A critical component is a component used in a life-support device or system whose failure can reasonably be expected to cause the failure of that life-support device or system, or to affect its safety or the effectiveness of that device or system.

\*\*) Life support devices or systems are intended (a) to be implanted in the human body, or (b) to support and/or maintain and sustain human life. If they fail, it is reasonable to assume that the health and the life of the user may be endangered.

**Glossary**

- 1) **Thermal resistance:** junction -ambient, mounted on PC-board (FR4), pads size 16 mm<sup>2</sup> each
- 2) **Typical Values:** Due to the special conditions of the manufacturing processes of LED, the typical data or calculated correlations of technical parameters can only reflect statistical figures. These do not necessarily correspond to the actual parameters of each single product, which could differ from the typical data and calculated correlations or the typical characteristic line. If requested, e.g. because of technical improvements, these typ. data will be changed without any further notice.



**Published by OSRAM Opto Semiconductors GmbH**  
**Leibnizstraße 4, D-93055 Regensburg**  
**www.osram-os.com © All Rights Reserved.**

EU RoHS and China RoHS compliant product



此产品符合欧盟 RoHS 指令的要求；  
按照中国的相关法规和标准，不含有毒有害物质或元素。