

PLED5 QFN Series

RoHS

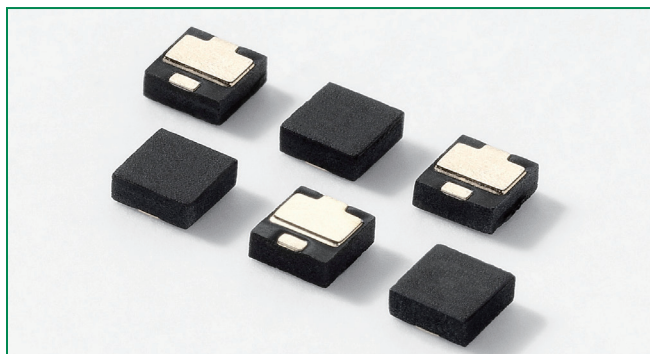

Description

This PLED5 Open LED Protector device provides three methods for increasing the reliability of LED lighting:

- 1) If one of the LEDs in an array fails open, this device provides a substitute electronic path so that the string continues to function.
- 2) It protects against ESD events up to ± 8 kV for contact discharges and ± 15 kV for air discharges per the IEC 61000-4-2 electrostatic immunity standard.
- 3) It provides protection in the case of accidental reverse battery or power connection.

High reliability of lighting functions such as traffic lighting, aircraft lighting, advertising lighting, and runway lighting demand the use of a device such as the PLED5.

Littelfuse offers overcurrent devices for implementation in power circuits that can also enhance the reliability of circuit operation. Our full line of circuit protection products can be viewed at www.littelfuse.com.

Schematic Symbol

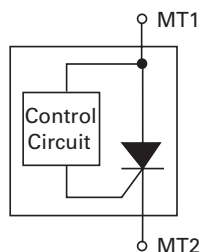

Pinout

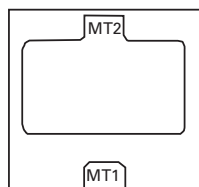

Features & Benefits

- Reverse Battery/Power Protection
- Low Turn-On (Trigger Voltage)
- ESD, IEC 61000-4-2, ± 8 kV contact, ± 15 kV air
- Ideal for MR16, PAR type lamps
- Open LED bypass up to 500 mA
- RoHS Compliant
- Fast Switching
- Resets After Power Cycle

Electrical Characteristics

Part	Marking	Symbol	Parameter	Conditions	MIN	TYP	MAX	Unit	
PLED5Q12	Px5	V_{AK}	Input Voltage				40	V	
		V_{TO}	Turn-On Voltage		4.65	4.9	5.15	V	
		I_S	Switching Current				20	mA	
		V_{OS}	On-State Voltage	$I_{AK} = 350$ mA		1	1.3	V	
		I_{OS}	On-State Current	(with adequate heat sinking)			500	mA	
		V_{OSR}	Reverse On-State Voltage	$I = 350$ mA		1	1.4	V	
		I_{OSR}	Reverse On-State Current				500	mA	
		I_{DRM}	Leakage Current	$V_{AK} = 3.5$ V			100	150	μ A
		V_{ESD}	ESD Withstand Voltage ¹	IEC61000-4-2 (Contact)		± 8			kV
IEC61000-4-2 (Air)		± 15				kV			

Notes:

¹Parameter is guaranteed by design and/or device characterization.

Thermal Considerations

Package	Symbol	Parameter	Value	Unit
 QFN	T_{OP}	Operating Temperature	-40 to 85	°C
	T_J	Maximum Junction Temperature	150	°C
	T_{STOR}	Storage Temperature	-65 to 150	°C

V-I Characteristics

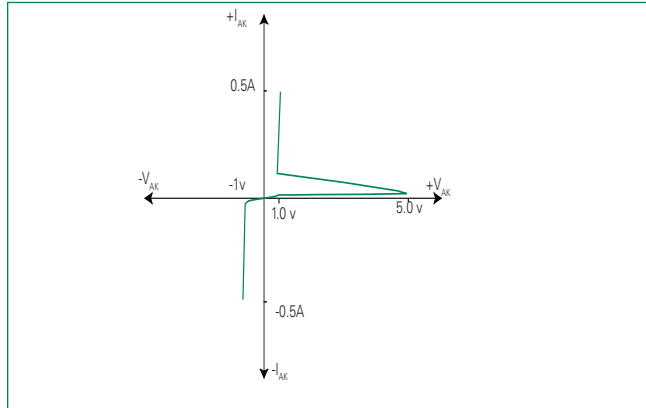

Switching Current vs Temperature

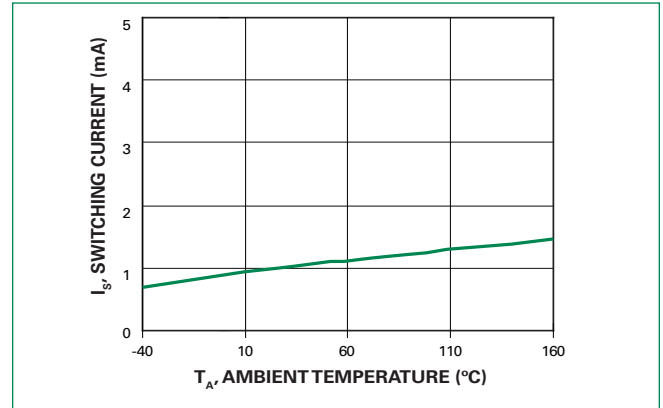

Turn On Voltage vs Temperature

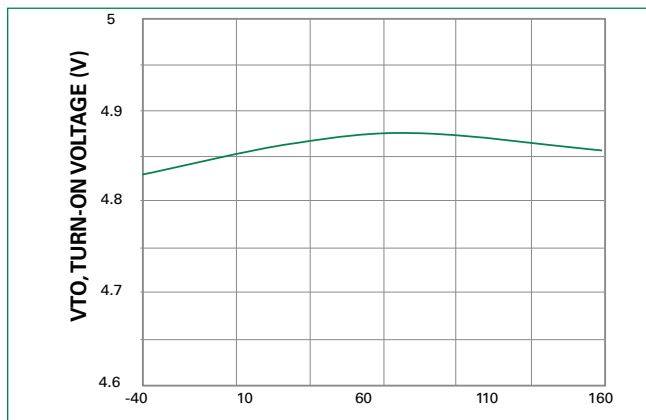

Leakage Current vs Temperature

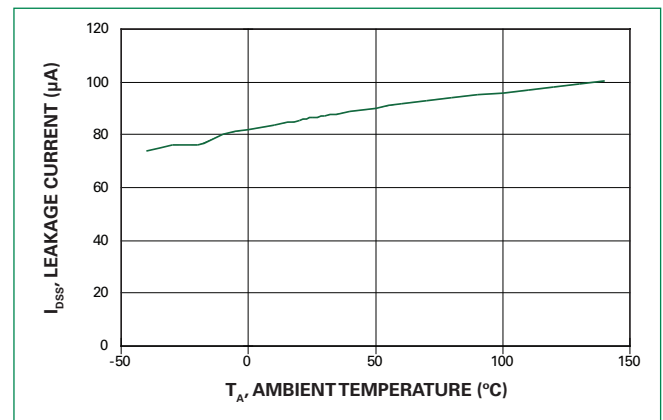

LED Application and Interference Test Circuit

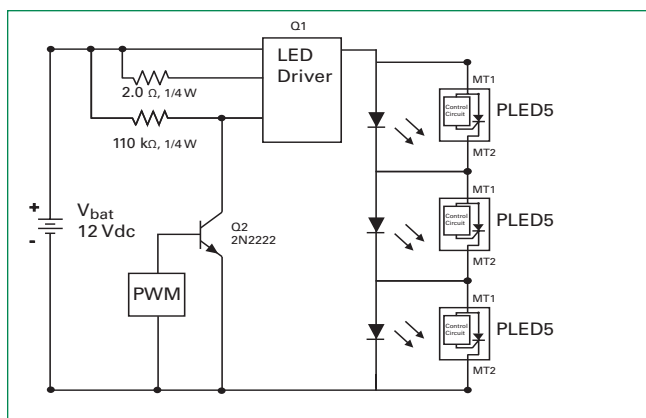

Soldering Parameters

Reflow Condition		Pb – Free assembly
Pre Heat	- Temperature Min ($T_{s(min)}$)	150°C
	- Temperature Max ($T_{s(max)}$)	200°C
	- Time (min to max) (t_s)	60 – 180 secs
Average ramp up rate (Liquidus Temp (T_L) to peak)		3°C/second max
$T_{s(max)}$ to T_L - Ramp-up Rate		3°C/second max
Reflow	- Temperature (T_L) (Liquidus)	217°C
	- Temperature (t_L)	60 – 150 seconds
Peak Temperature (T_p)		260 ^{+0/-5} °C
Time within 5°C of actual peak Temperature (t_p)		30 seconds
Ramp-down Rate		6°C/second max
Time 25°C to peak Temperature (T_p)		8 minutes max
Do not exceed		260°C

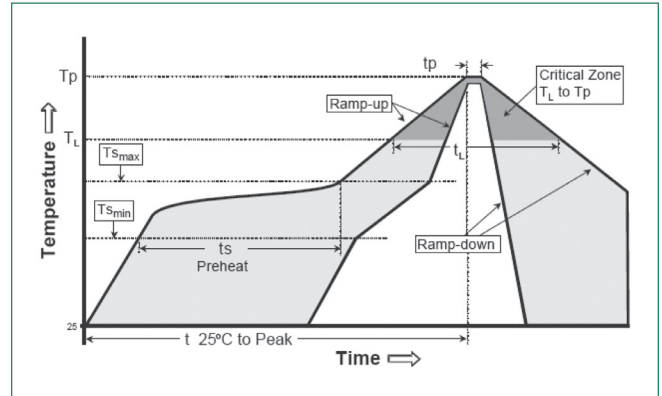

Physical Specifications

Terminal Material	Copper Alloy
Terminal Finish	100% Matte Tin Plated
Body Material	UL recognized epoxy meeting flammability classification 94V-0

Ordering Information

Catalog Number	Package Type	Quantity Per Reel
PLED5Q12	QFN	3000 Pieces

Part Numbering System

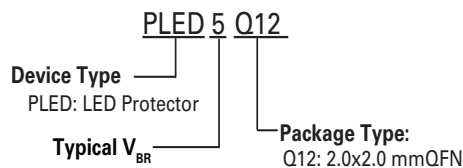

Environmental Specifications

High Temperature Voltage Blocking	MIL-STD-750: Method 1040, Condition A 80% min V_{BR} DC, 150°C, 504 hours
Temperature Cycling	MIL-STD-750: Method 1051 -65°C to 150°C, 15-minute dwell, 100 cycles
Biased Temperature & Humidity	EIA/JEDEC: JESD22-A101 80% min V_{BR} , 85°C, 85% RH, 1008 hours
Resistance to Solder Heat	MIL-STD-750: Method 2031 260°C, 10 seconds
Moisture Sensitivity Level	JEDEC-J-STC-020D, Level 1
Burn-In Test	$T_j = 150^\circ\text{C}$, $IT = 0.350$ Adc, 1008 hours

Part Marking System

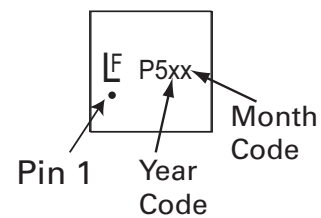

Package Dimensions - QFN

Device Dimensions:

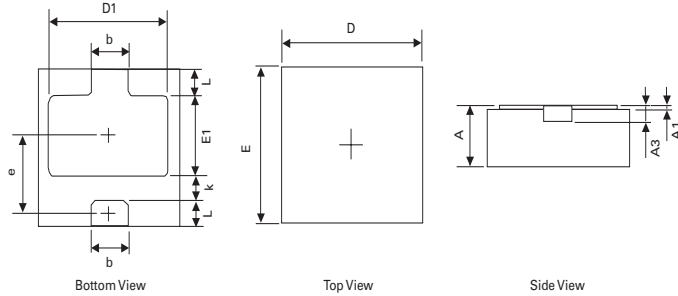

Recommended Soldering Pad Dimensions:

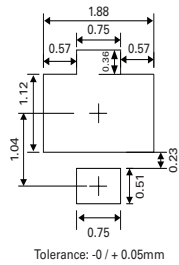

Dimension Symbol	Millimetres	
	Min	Max
A	0.700/0.800	0.800/0.900
A1	0.000	0.050
A3	0.203REF	
D	1.924	2.076
E	1.924	2.076
D1	1.580	1.780
E1	0.820	1.020
k	0.200MIN.	
b	0.550	0.650
e	1.045TYP.	
L	0.254	0.406

Tape and Reel Specification - QFN

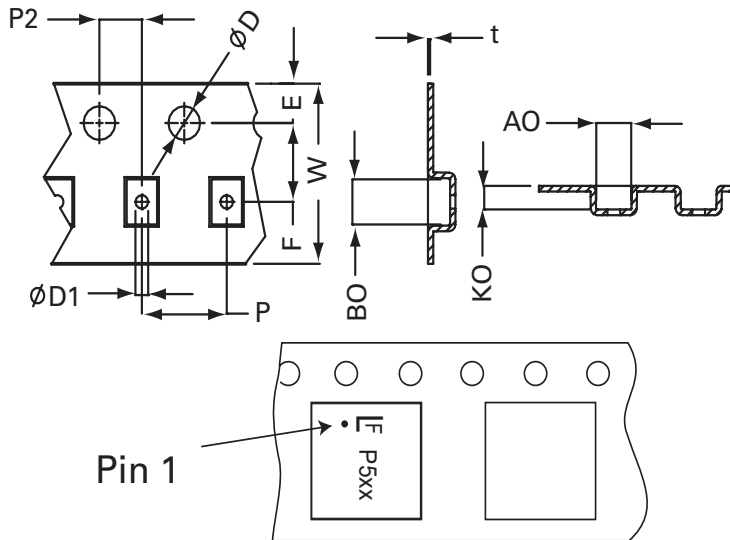

	Millimetres		Inches	
	Min	Max	Min	Max
E	1.65	1.85	0.065	0.073
F	3.45	3.55	0.136	0.140
D1	1.00	-	0.040	-
D	1.50 min		0.059 min	
P	3.90	4.10	0.154	0.161
W	7.70	8.30	0.303	0.327
P2	1.95	2.05	0.077	0.081
A0	2.20	2.30	0.086	0.090
B0	2.20	2.30	0.086	0.090
K0	0.64	0.74	0.025	0.029
t	0.20 typ		0.007 typ	