

MOS FET Relays

G3VM-351AY/DY

Compact, General-purpose, Analog-switching MOS FET Relays, with Dielectric Strength of 5 kVAC between I/O Using Optical Isolation.

- Trigger LED forward current of 2 mA (maximum) facilitates power saving designs.
- Switches minute analog signals.
- Continuous load current of 100 mA.



NEW

Note: The actual product is marked differently from the image shown here.

RoHS compliant

⚠ Refer to "Common Precautions".

Application Examples

- Power meter
- Measurement devices
- Security systems
- Industrial equipment

List of Models

Contact form	Terminals	Load voltage (peak value) (See the note.)	Model	Number per stick	Number per tape
SPST-NO	PCB terminals	350 V	G3VM-351AY	100	---
	Surface-mounting terminals		G3VM-351DY		
			G3VM-351DY(TR)	---	1,500

Note: The AC peak and DC value are given for the load voltage.

Dimensions

Note: All units are in millimeters unless otherwise indicated.

G3VM-351AY

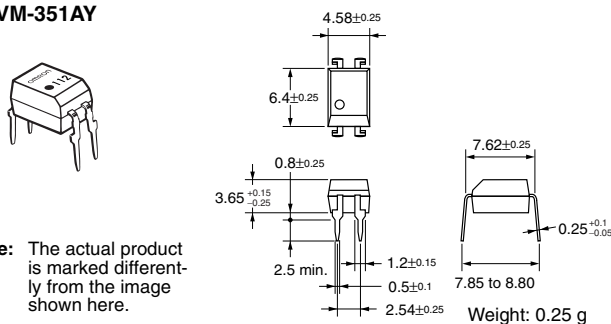

Note: The actual product is marked differently from the image shown here.

G3VM-351DY

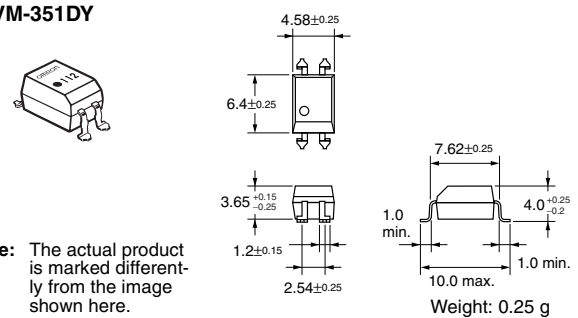

Note: The actual product is marked differently from the image shown here.

Terminal Arrangement/Internal Connections (Top View)

G3VM-351AY

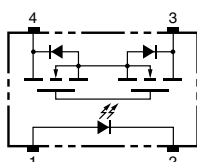

G3VM-351DY

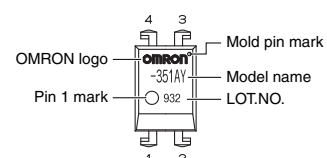
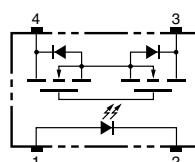

Note: The actual product is marked differently from the image shown here.

PCB Dimensions (Bottom View)

G3VM-351AY

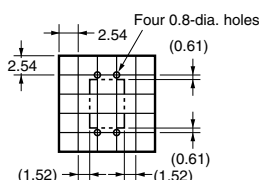

Actual Mounting Pad Dimensions (Recommended Value, Top View)

G3VM-351DY

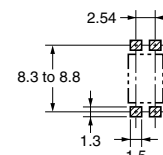

Absolute Maximum Ratings (Ta = 25°C)

Item	Symbol	Rating	Unit	Measurement Conditions	
Input	LED forward current	I_F	30	mA	
	Repetitive peak LED forward current	I_{FP}	1	A	100 μ s pulses, 100 pps
	LED forward current reduction rate	$\Delta I_F/^\circ\text{C}$	-0.3	mA/ $^\circ\text{C}$	Ta \geq 25°C
	LED reverse voltage	V_R	5	V	
	Connection temperature	T_j	125	$^\circ\text{C}$	
Output	Load voltage (AC peak/DC)	V_{OFF}	350	V	
	Continuous load current (AC peak/DC)	I_O	100	mA	
	ON current reduction rate	$\Delta I_O/^\circ\text{C}$	-1.0	mA/ $^\circ\text{C}$	Ta \geq 25°C
	Pulse ON current	I_{op}	0.3	A	t = 100 ms, Duty = 1/10
	Connection temperature	T_j	125	$^\circ\text{C}$	
Dielectric strength between input and output (See note 1.)		V_{I-O}	5,000	Vrms	AC for 1 min
Operating temperature		T_a	-40 to +85	$^\circ\text{C}$	With no icing or condensation
Storage temperature		T_{stg}	-55 to +125	$^\circ\text{C}$	With no icing or condensation
Soldering temperature (10 s)		---	260	$^\circ\text{C}$	10 s

Note: 1. The dielectric strength between the input and output was checked by applying voltage between all pins as a group on the LED side and all pins as a group on the light-receiving side.

Electrical Characteristics (Ta = 25°C)

Item	Symbol	Minimum	Typical	Maximum	Unit	Measurement conditions	
Input	LED forward voltage	V_F	1.45	1.63	1.75	V	$I_F = 10$ mA
	Reverse current	I_R	---	---	10	μA	$V_R = 5$ V
	Capacity between terminals	C_T	---	40	---	pF	V = 0, f = 1 MHz
	Trigger LED forward current	I_{FT}	---	0.3	2	mA	$I_O = 100$ mA
Output	Maximum resistance with output ON	R_{ON}	---	25	35	Ω	$I_F = 5$ mA, $I_O = 100$ mA, t < 1 s
			---	35	50		$I_F = 5$ mA, $I_O = 100$ mA
	Current leakage when the relay is open	I_{LEAK}	---	---	1.0	μA	$V_{OFF} = 350$ V
Capacity between terminals		C_{OFF}	---	30	---	pF	V = 0, f = 1 MHz
Capacity between I/O terminals		C_{I-O}	---	0.8	---	pF	f = 1 MHz, Vs = 0 V
Insulation resistance		R_{I-O}	1,000	---	---	M Ω	$V_{I-O} = 500$ VDC, RoH \leq 60%
Turn-ON time		tON	---	0.1	1	ms	$I_F = 5$ mA, $R_L = 200$ Ω , $V_{DD} = 20$ V (See note 2.)
Turn-OFF time		tOFF	---	0.2	1	ms	

Note: 2. Turn-ON and Turn-OFF Times

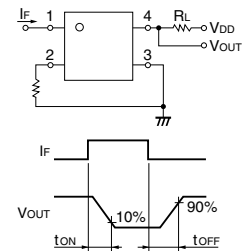

Recommended Operating Conditions

Use the G3VM under the following conditions so that the Relay will operate properly.

Item	Symbol	Minimum	Typical	Maximum	Unit
Load voltage (AC peak/DC)	V_{DD}	---	---	280	V
Operating LED forward current	I_F	3	5	20	mA
Continuous load current (AC peak/DC)	I_O	---	---	100	mA
Operating temperature	T_a	-20	---	65	$^\circ\text{C}$

Engineering Data

Load Current vs. Ambient Temperature G3VM-351AY(DY)

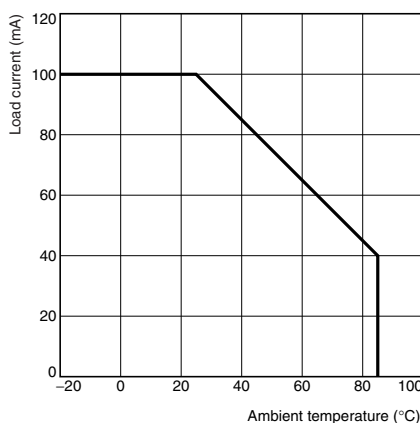

Safety Precautions

Refer to "Common Precautions" for all G3VM models.