

MGA-71543

Low Noise Amplifier with Mitigated Bypass Switch



Data Sheet

Description

Avago's MGA-71543 is an economical, easy-to-use GaAs MMIC Low Noise Amplifier (LNA), which is designed for adaptive CDMA and W-CDMA receiver systems. The MGA-71543 is part of the Avago Technologies complete CDMAAdvantage RF chipset.

The MGA-71543 features a minimum noise figure of 0.8 dB and 16 dB available gain from a single stage, feedback FET amplifier. The input and output are partially matched, and only a simple series/shunt inductor match is required to achieve low noise figure and VSWR into 50Ω.

When set into the bypass mode, both input and output are internally matched through a mitigative circuit. This circuit draws no current, yet duplicates the in and out impedance of the LNA. This allows the system user to have minimum mismatch change from LNA to bypass mode, which is very important when the MGA-71543 is used between duplexers and/or filters.

The MGA-71543 offers an integrated solution of LNA with adjustable IIP3. The IIP3 can be fixed to a desired current level for the receiver's linearity requirements.

The LNA has a bypass switch function, which provides low insertion loss at zero current. The bypass mode also boosts dynamic range when high level signal is being received.

The MGA-71543 is designed for CDMA and W-CDMA receiver systems. The IP3, Gain, and mitigative network are tailored to these applications where filters are used. Many CDMA systems operate 20% LNA mode, 80% bypass. With the bypass current draw of zero and LNA of 10 mA, the MGA-71543 allows an average 2 mA current.

The MGA-71543 is a GaAs MMIC, processed on Avago's cost effective PHEMT (Pseudomorphic High Electron Mobility Transistor Technology). It is housed in the SOT343 (SC70 4-lead) package.

Features

- Lead-free Option Available
- Operating frequency: 0.1 GHz ~ 6.0 GHz
- Noise figure: 0.8 dB (NFmin)
- Gain: 16 dB
- Average I_{dd} = 2mA in CDMA handset
- Bypass switch on chip Loss = -5.6 dB (I_d < 5 μA) IIP3 = +35 dBm
- Adjustable input IP3: 0 to +9 dBm
- 2.7 V to 4.2V operation

Applications

- CDMA (IS-95, J-STD-008) Receiver LNA
- Transmit Driver Amp
- W-CDMA Receiver LNA
- TDMA (IS-136) handsets



Attention:
Observe precautions for handling electrostatic sensitive devices.
ESD Machine Model (Class A)
ESD Human Body Model (Class 0)
Refer to Avago Application Note A004R: Electrostatic Discharge Damage and Control.

Surface Mount Package SOT-343/4-lead SC70

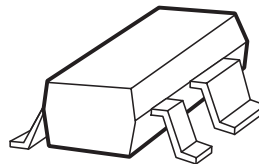

Pin Connections and Package Marking

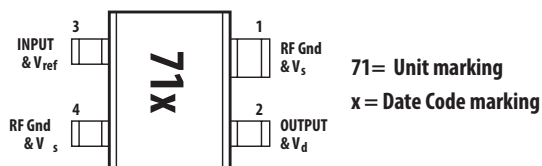

Functional Block Diagram

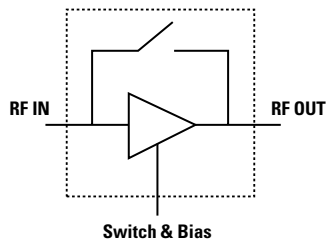

Simplified Schematic

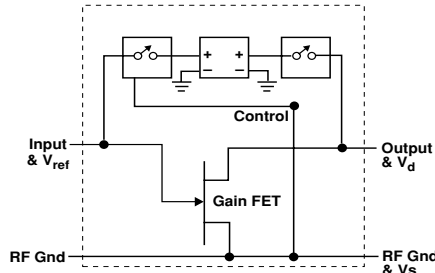

Evaluation Test Circuit (single positive bias)

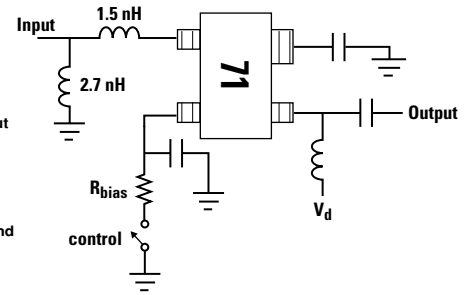

MGA-71543 Absolute Maximum Ratings^[1]

Symbol	Parameter	Units	Absolute Maximum	Operation Maximum
V_d	Maximum Input to Output Voltage ^[4]	V	5.5	4.2
V_c	Maximum Input to Ground DC Voltage ^[4]	V	+3 -5.5	+1 -4.2
I_d	Supply Current	mA	60	50
P_d	Power Dissipation ^[2]	mW	240	200
P_{in}	CW RF Input Power	dBm	+15	+10
T_j	Junction Temperature	°C	170	150
T_{STG}	Storage Temperature	°C	-65 to +150	-40 to +85

Thermal Resistance:^[2,3]

$$\theta_{jc} = 240^\circ\text{C/W}$$

Notes:

1. Operation of this device in excess of any of these limits may cause permanent damage.
2. Ground lead temperature at 25°C.
3. Thermal resistance measured by 150°C Liquid Crystal Measurement method.
4. Maximum rating assumes other parameters are at DC quiescent conditions.

Product Consistency Distribution Charts^[5,6]

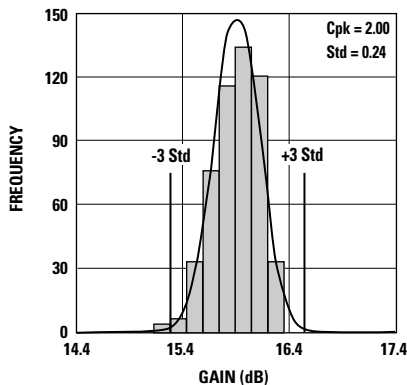

Figure 1. Gain @ 2 GHz, 3V, 10 mA.
LSL = 14.4, Nominal = 15.9, USL = 17.4

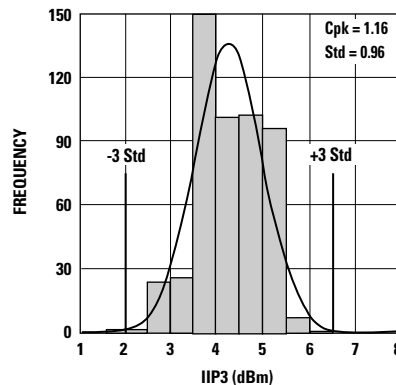

Figure 2. IIP3 @ 2 GHz, 3V, 10 mA.
LSL = 1.0, Nominal = 3.0, USL = 8.0

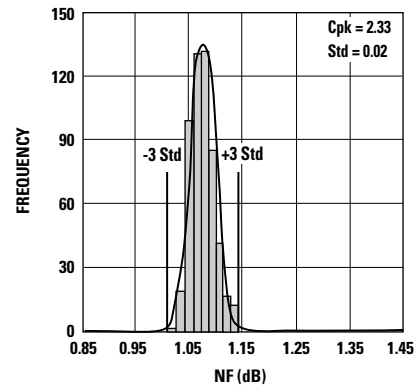

Figure 3. NF @ 2 GHz, 3V, 10 mA.
LSL = 0.85, Nominal = 1.08, USL = 1.45

Notes:

5. Distribution data sample size is 450 samples taken from 9 different wafers. Future wafers allocated to this product may have nominal values anywhere within the upper and lower specification limits.
6. Measurements made on production test board, Figure 4. This circuit represents a trade-off between an optimal noise match and a realizable match based on production test requirements at 10 mA bias current.

Excess circuit losses have been de-embedded from actual measurements. Performance may be optimized for different bias conditions and applications. Consult Application Note for details.

MGA-71543 Electrical Specifications

$T_c = +25^\circ\text{C}$, $Z_o = 50\Omega$, $I_d = 10\text{ mA}$, $V_d = 3\text{ V}$, unless noted

Symbol	Parameter and Test Condition	Units	Min.	Typ.	Max.	σ [1]	
Vref test	$V_{ds} = 2.4\text{ V}$	$I_d = 10\text{ mA}$	V	-0.86	-0.65	-0.43	0.041
NF test	$f = 2.01\text{ GHz}$ $V_d = 3.0\text{ V} (= V_{ds} - V_{ref})$	$I_d = 10\text{ mA}$	dB		1.1	1.45	0.02
Gain test	$f = 2.01\text{ GHz}$ $V_d = 3.0\text{ V} (= V_{ds} - V_{ref})$	$I_d = 10\text{ mA}$	dB	14.4	15.9	17.4	0.24
IIP3 test	$f = 2.01\text{ GHz}$ $V_d = 3.0\text{ V} (= V_{ds} - V_{ref})$	$I_d = 10\text{ mA}$	dBm	1	3.0		0.96
Gain, Bypass	$f = 2.01\text{ GHz}$ $V_{ds} = 0\text{ V}$, $V_{ref} = -3\text{ V}$ Bypass Mode ^[6]	$I_d = 0\text{ mA}$	dB	-6.4	-5.6		0.12
Ig test	Bypass Mode $V_{ds} = 0\text{ V}$, $V_{ref} = -3\text{ V}$ ^[6]	$I_d = 0\text{ mA}$	μA		2.0		1.5
NFmin ^[3]	Minimum Noise Figure As measured in Figure 5 Test Circuit (Γ_{opt} computed from s-parameter and noise parameter performance as measured in a 50Ω impedance fixture)	$f = 0.9\text{ GHz}$ $f = 1.5\text{ GHz}$ $f = 1.9\text{ GHz}$ $f = 2.1\text{ GHz}$ $f = 2.5\text{ GHz}$ $f = 6.0\text{ GHz}$	dB		0.7 0.7 0.8 0.8 0.8 1.1		
Ga ^[3]	Associated Gain at Nfo As measured in Figure 5 Test Circuit (G_{opt} computed from s-parameter and noise parameter performance as measured in a 50Ω impedance fixture)	$f = 0.9\text{ GHz}$ $f = 1.5\text{ GHz}$ $f = 1.9\text{ GHz}$ $f = 2.1\text{ GHz}$ $f = 2.5\text{ GHz}$ $f = 6.0\text{ GHz}$	dB		17.1 16.4 15.8 15.4 14.9 10.0		
P1dB	Output Power at 1 dB Gain Compression As measured in Evaluation Test Circuit with source resistor biasing ^[4,5] Frequency = 2.01 GHz	$I_d = 6\text{ mA}$ $I_d = 10\text{ mA}$ $I_d = 20\text{ mA}$ $I_d = 40\text{ mA}$	dBm		+3.0 +7.4 +13.1 +15.5		
IIP3	Input Third Order Intercept Point As measured in Figure 4 Test Circuit ^[5] Frequencies = 2.01 GHz, 2.02 GHz	$I_d = 6\text{ mA}$ $I_d = 10\text{ mA}$ $I_d = 20\text{ mA}$ $I_d = 40\text{ mA}$	dBm		-0.5 +3.0 +7.4 +8.7		
Switch	Bypass Switch Rise/Fall Time (10% - 90%) As measured in Evaluation Test Circuit	Intrinsic Eval Circuit			10 100		
RLin	Input Return Loss as measured in Fig. 4	$f = 2.01\text{ GHz}$	dB		6.0		0.31
RLout	Output Return Loss as measured in Fig. 4	$f = 2.01\text{ GHz}$	dB		10.9		0.65
ISOL	Isolation $ s_{12} ^2$ as measured in Fig. 5	$f = 2.01\text{ GHz}$	dB		-22.5		

Notes:

- Standard Deviation and Typical Data based at least 450 part sample size from 9 wafers. Future wafers allocated to this product may have nominal values anywhere within the upper and lower spec limits.
- Measurements made on a fixed tuned production test circuit (Figure 4) that represents a trade-off between optimal noise match, maximum gain match, and a realizable match based on production test board requirements at 10 mA bias current. Excess circuit losses have been de-embedded from actual measurements. $V_d = V_{ds} - V_{ref}$ where V_{ds} is adjusted to maintain a constant V_d bias equivalent to a single supply 3V bias application. Consult Applications Note for circuit biasing options.
- Minimum Noise Figure and Associated Gain data computed from s-parameter and noise parameter data measured in a 50Ω system using ATN NP5 test system. Data based on 10 typical parts from 9 wafers. Associated Gain is the gain when the product input is matched for minimum Noise Figure.
- P1dB measurements were performed in the evaluation circuit with source resistance biasing. As P1dB is approached, the drain current is maintained near the quiescent value by the feedback effect of the source resistor in the evaluation circuit. Consult Applications Note for circuit biasing options.
- Measurements made on a fixed tuned production test circuit that represents a trade-off between optimal noise match, maximum gain match, and a realizable match based on production test board requirements at 10 mA bias current. Performance may be optimized for different bias conditions and applications. Consult Applications Note.
- The Bypass Mode test conditions are required only for the production test circuit (Figure 4) using the gate bias method. In the preferred source resistor bias configuration, the Bypass Mode is engaged by presenting a DC open circuit instead of the bias resistor on Pin 4.

MGA-71543 Typical Performance

$T_c = 25^\circ\text{C}$, $Z_o = 50$, $V_d = 3\text{V}$, $I_d = 10\text{ mA}$ unless stated otherwise. Data vs. frequency was measured in Figure 5 test system and was optimized for each frequency with external tuners.

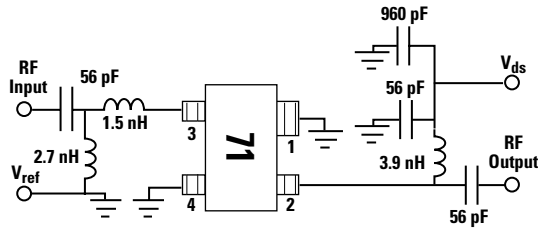

Figure 4. MGA-71543 Production Test Circuit.

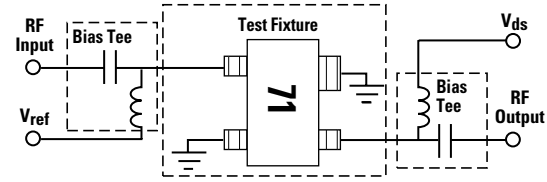

Figure 5. MGA-71543 Test Circuit for S, Noise, and Power Parameters over Frequency.

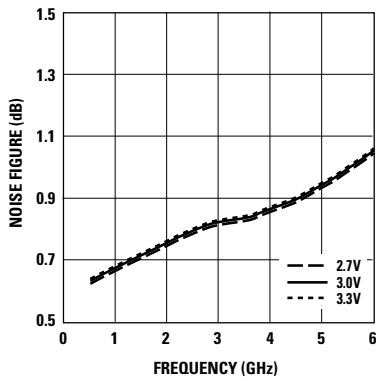

Figure 6. Minimum Noise Figure vs. Frequency and Voltage.

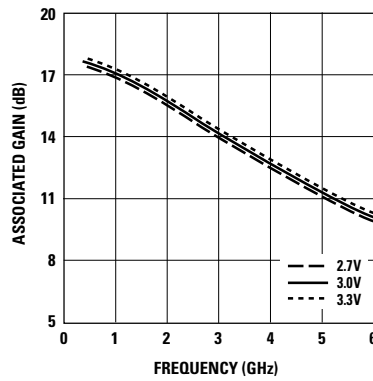

Figure 7. Associated Gain with Fmin vs. Frequency and Voltage.

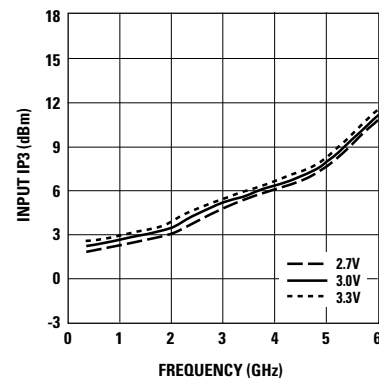

Figure 8. Input Third Order Intercept Point vs. Frequency and Voltage.

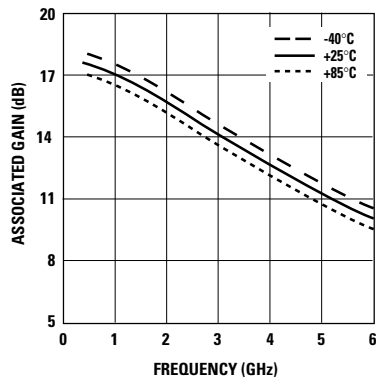

Figure 9. Associated Gain with Fmin vs. Frequency.

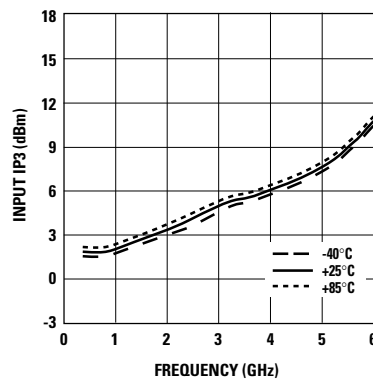

Figure 10. Input Third Order Intercept Point vs. Frequency and Temperature.

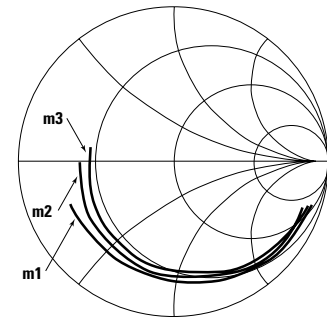

Figure 11. S11 Impedance vs. Frequency. (m1 = Sw, m2 = 6 mA, m3 = 10 mA)

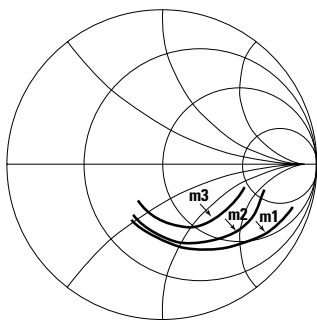

Figure 12. S22 Impedance vs. Frequency. (m1 = Sw, m2 = 6 mA, m3 = 10 mA)

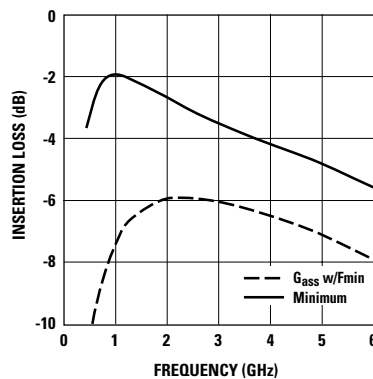

Figure 13. Bypass Mode Associated Insertion Loss with Fmin Match and Minimum Loss vs. Frequency.

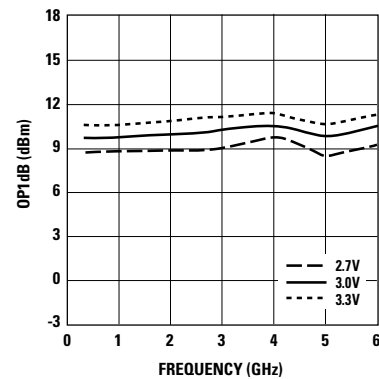

Figure 14. Output Power at 1 dB Compression vs. Frequency and Voltage.^[4]

MGA-71543 Typical Performance, continued

$T_c = 25^\circ\text{C}$, $Z_o = 50$, $V_d = 3\text{V}$, $I_d = 10\text{ mA}$ unless stated otherwise. Data vs. frequency was measured in Figure 5 test system and was optimized for each frequency with external tuners.

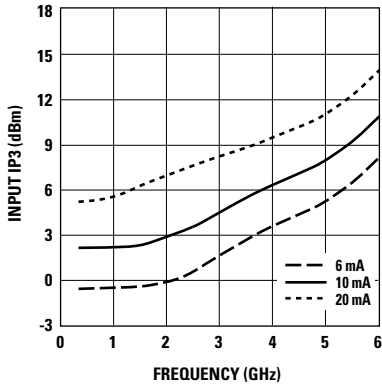

Figure 15. Input Third Order Intercept Point vs. Frequency and Current.

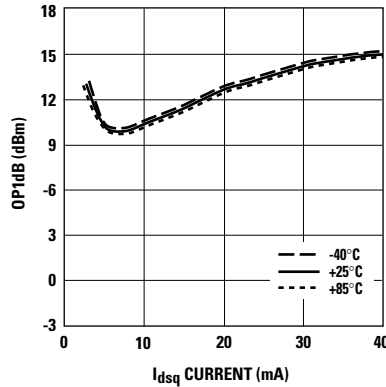

Figure 16. Output Power at 1 dB Compression vs. I_{dsq} Current and Temperature (Passive Bias, V_{ref} Fixed)[4].

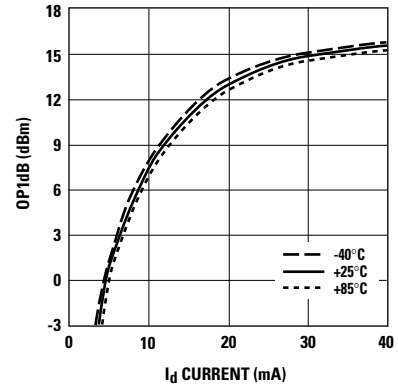

Figure 17. Output Power at 1 dB Compression vs. Current and Temperature (Source Resistor Bias in Evaluation Circuit)[5].

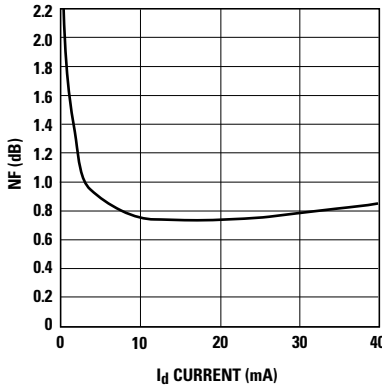

Figure 18. Minimum Noise Figure vs. Current (2 GHz).

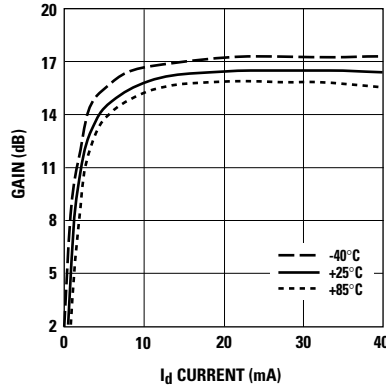

Figure 19. Gain vs. Current and Temperature (2 GHz).

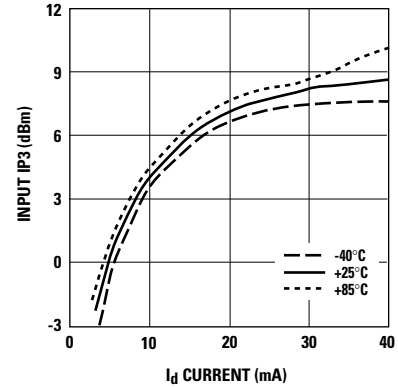

Figure 20. Input Third Intercept Point vs. Current and Temperature (2 GHz).

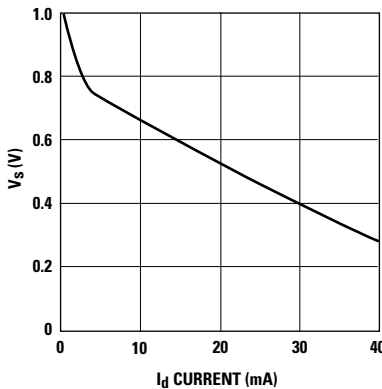

Figure 21. Control Voltage vs. Current.

Notes:

4. P1dB measurements were performed with passive biasing in Production Test Circuit (Figure 4.). Quiescent drain current, I_{dsq} , is set by a fixed V_{ref} with no RF drive applied. As P1dB is approached, the drain current may increase or decrease depending on frequency and DC bias point which typically results in

higher P1dB than if the drain current is maintained constant by active biasing.
5. P1dB measurements were performed in Evaluation Test Circuit with source resistor biasing which maintains the drain current near the quiescent value under large signal conditions.

MGA-71543 Typical Scattering Parameters

$T_C = 25^\circ\text{C}$, $V_{ds} = 0\text{V}$, $V_{ref} = -3.0\text{V}$, $I_d = 0\text{mA}$ (bypass mode), $Z_0 = 50\Omega$

Freq (GHz)	S ₁₁ Mag.	S ₁₁ Ang.	S ₂₁ Mag.	S ₂₁ Ang.	S ₁₂ Mag.	S ₁₂ Ang.	S ₂₂ Mag.	S ₂₂ Ang.	S ₂₁ (dB)	G _{max} (dB)	RL _{in} (dB)	RL _{out} (dB)	Isolation (dB)
0.1	0.968	-4.5	0.021	41.1	0.021	41.3	0.936	-5.9	-33.6	-12.5	-0.3	-0.6	-33.6
0.2	0.961	-8.4	0.039	70.5	0.039	70.8	0.916	-9.5	-28.2	-9.1	-0.3	-0.8	-28.2
0.3	0.951	-11.4	0.065	73.7	0.064	73.9	0.901	-13.1	-23.7	-6.3	-0.4	-0.9	-23.9
0.4	0.947	-14.8	0.09	70.9	0.09	71	0.89	-16.5	-20.9	-4.2	-0.5	-1.0	-20.9
0.5	0.937	-18.1	0.114	65.7	0.114	65.9	0.871	-20.2	-18.9	-3.6	-0.6	-1.2	-18.9
0.6	0.929	-21.3	0.136	61.4	0.136	61.5	0.861	-23.7	-17.3	-2.8	-0.6	-1.3	-17.3
0.7	0.921	-24.5	0.157	57	0.157	57.1	0.846	-27.1	-16.1	-2.4	-0.7	-1.5	-16.1
0.8	0.913	-27.7	0.176	52.7	0.176	52.8	0.833	-30.3	-15.1	-2.2	-0.8	-1.6	-15.1
0.9	0.905	-30.8	0.194	48.6	0.194	48.7	0.82	-33.3	-14.2	-2.0	-0.9	-1.7	-14.2
1	0.895	-33.7	0.211	44.5	0.211	44.6	0.806	-36.3	-13.5	-1.9	-1.0	-1.9	-13.5
1.1	0.887	-36.6	0.226	40.6	0.226	40.6	0.791	-39.2	-12.9	-1.9	-1.0	-2.0	-12.9
1.2	0.878	-39.4	0.239	36.8	0.239	36.9	0.776	-41.9	-12.4	-2.0	-1.1	-2.2	-12.4
1.3	0.869	-42.1	0.252	33.2	0.252	33.3	0.762	-44.4	-12.0	-2.1	-1.2	-2.4	-12.0
1.4	0.862	-44.7	0.264	29.7	0.263	29.8	0.748	-46.9	-11.6	-2.1	-1.3	-2.5	-11.6
1.5	0.854	-47.3	0.274	26.3	0.274	26.4	0.732	-49.2	-11.2	-2.2	-1.4	-2.7	-11.2
1.6	0.847	-49.8	0.283	23.1	0.283	23.2	0.719	-51.4	-11.0	-2.3	-1.4	-2.9	-11.0
1.7	0.839	-52.4	0.293	19.9	0.292	20	0.705	-53.5	-10.7	-2.4	-1.5	-3.0	-10.7
1.8	0.832	-54.8	0.3	16.8	0.3	16.9	0.692	-55.5	-10.5	-2.5	-1.6	-3.2	-10.5
1.9	0.825	-57.1	0.308	13.8	0.307	14	0.679	-57.6	-10.2	-2.6	-1.7	-3.4	-10.3
2	0.819	-59.5	0.314	11	0.314	11.1	0.665	-59.4	-10.1	-2.7	-1.7	-3.5	-10.1
2.1	0.812	-61.7	0.321	8.1	0.32	8.2	0.653	-61.2	-9.9	-2.8	-1.8	-3.7	-9.9
2.2	0.806	-63.9	0.326	5.3	0.326	5.4	0.639	-63	-9.7	-2.9	-1.9	-3.9	-9.7
2.3	0.8	-66.3	0.331	2.6	0.331	2.7	0.627	-64.6	-9.6	-3.0	-1.9	-4.1	-9.6
2.4	0.792	-68.5	0.336	0	0.336	0.1	0.616	-66.3	-9.5	-3.1	-2.0	-4.2	-9.5
2.5	0.787	-70.9	0.341	-2.7	0.34	-2.5	0.603	-67.8	-9.3	-3.2	-2.1	-4.4	-9.4
3	0.76	-81.8	0.359	-15.1	0.358	-15	0.548	-75.5	-8.9	-3.6	-2.4	-5.2	-8.9
3.5	0.74	-93.4	0.371	-27.1	0.37	-27	0.497	-83.4	-8.6	-3.9	-2.6	-6.1	-8.6
4	0.721	-106	0.377	-39.1	0.377	-39	0.452	-91.6	-8.5	-4.3	-2.8	-6.9	-8.5
4.5	0.708	-119.8	0.379	-51	0.378	-50.9	0.418	-100.7	-8.4	-4.6	-3.0	-7.6	-8.5
5	0.7	-134.7	0.374	-63.2	0.374	-63	0.393	-110.7	-8.5	-4.9	-3.1	-8.1	-8.5
5.5	0.7	-150.2	0.362	-75.2	0.362	-75.1	0.376	-121.1	-8.8	-5.2	-3.1	-8.5	-8.8
6	0.699	-165.1	0.347	-86.7	0.347	-86.5	0.361	-130.9	-9.2	-5.7	-3.1	-8.8	-9.2
6.5	0.705	179.7	0.328	-98.1	0.328	-98	0.35	-141.7	-9.7	-6.1	-3.0	-9.1	-9.7
7	0.708	165.3	0.307	-109.4	0.307	-109.4	0.336	-152	-10.3	-6.7	-3.0	-9.5	-10.3
8	0.705	136.3	0.262	-133.2	0.262	-133.1	0.292	-173.9	-11.6	-8.3	-3.0	-10.7	-11.6
9	0.728	106.4	0.202	-157.3	0.201	-157.2	0.242	156.3	-13.9	-10.4	-2.8	-12.3	-13.9
10	0.781	75	0.141	179.6	0.141	179.8	0.247	114.9	-17.0	-12.7	-2.1	-12.1	-17.0
11	0.815	48.9	0.083	156.7	0.083	156.8	0.306	80.3	-21.6	-16.5	-1.8	-10.3	-21.6
12	0.838	28.2	0.034	134.9	0.034	135.6	0.367	54.2	-29.4	-23.5	-1.5	-8.7	-29.4
13	0.847	8.5	0.005	-22.1	0.005	-19.9	0.414	29.4	-46.0	-39.7	-1.4	-7.7	-46.0
14	0.85	-10.6	0.037	-73.5	0.036	-73.5	0.478	4.7	-28.6	-21.9	-1.4	-6.4	-28.9
15	0.856	-28.5	0.058	-94	0.057	-94.1	0.555	-15.7	-24.7	-17.4	-1.4	-5.1	-24.9
16	0.848	-43.4	0.072	-112.3	0.072	-112.2	0.626	-30.1	-22.9	-15.2	-1.4	-4.1	-22.9
17	0.844	-53.9	0.083	-127.4	0.083	-127.3	0.669	-44	-21.6	-13.6	-1.5	-3.5	-21.6
18	0.873	-65.2	0.088	-145.2	0.088	-144.4	0.706	-58.7	-21.1	-11.9	-1.2	-3.0	-21.1

MGA-71543 Typical Scattering Parameters and Noise Parameters

$T_C = 25^\circ\text{C}$, $V_{ds} = 2.25\text{ V}$, $V_{ref} = -0.77\text{ V}$, $I_d = 3\text{ mA}$, $Z_0 = 50\Omega$

Freq (GHz)	S ₁₁ Mag.	S ₁₁ Ang.	S ₂₁ Mag.	S ₂₁ Ang.	S ₁₂ Mag.	S ₁₂ Ang.	S ₂₂ Mag.	S ₂₂ Ang.	S ₂₁ (dB)	G _{max} (dB)	RL _{in} (dB)	RL _{out} (dB)	Isolation (dB)
0.3	0.927	-10.1	2.945	170.7	0.028	23.9	0.754	-7.9	9.4	21.6	-0.7	-2.5	-31.1
0.5	0.921	-16.4	2.939	164.1	0.032	32.9	0.744	-12.6	9.4	21.1	-0.7	-2.6	-29.9
0.7	0.915	-22.7	2.907	158.3	0.039	38.7	0.742	-17.5	9.3	20.6	-0.8	-2.6	-28.2
0.9	0.909	-28.8	2.871	152.6	0.047	41.3	0.74	-22.1	9.2	20.2	-0.8	-2.6	-26.6
1.1	0.899	-34.8	2.826	147	0.054	41.5	0.736	-26.7	9.0	19.6	-0.9	-2.7	-25.4
1.3	0.891	-40.5	2.783	141.5	0.062	40.5	0.732	-30.9	8.9	19.1	-1.0	-2.7	-24.2
1.5	0.883	-46.2	2.728	136.3	0.069	38.8	0.727	-34.9	8.7	18.6	-1.1	-2.8	-23.2
1.7	0.873	-51.7	2.693	131.1	0.076	36.7	0.721	-38.7	8.6	18.0	-1.2	-2.8	-22.4
1.9	0.863	-57	2.652	126.1	0.082	34.3	0.716	-42.5	8.5	17.5	-1.3	-2.9	-21.7
2	0.858	-59.7	2.63	123.7	0.086	33	0.711	-44.2	8.4	17.2	-1.3	-3.0	-21.3
2.1	0.852	-62.3	2.609	121.2	0.089	31.7	0.707	-46	8.3	17.0	-1.4	-3.0	-21.0
2.2	0.846	-64.8	2.593	118.7	0.092	30.4	0.703	-47.9	8.3	16.7	-1.5	-3.1	-20.7
2.3	0.841	-67.5	2.579	116.3	0.095	28.9	0.698	-49.5	8.2	16.5	-1.5	-3.1	-20.4
2.4	0.833	-70	2.554	113.9	0.098	27.5	0.695	-51.3	8.1	16.2	-1.6	-3.2	-20.2
2.5	0.828	-72.8	2.544	111.5	0.1	26.1	0.689	-52.9	8.1	15.9	-1.6	-3.2	-20.0
3	0.794	-85.6	2.479	99.7	0.114	18.5	0.66	-61.6	7.9	14.7	-2.0	-3.6	-18.9
3.5	0.758	-99.1	2.43	87.7	0.125	10.7	0.626	-70.5	7.7	13.6	-2.4	-4.1	-18.1
4	0.717	-113.5	2.373	75.6	0.134	2.1	0.587	-80	7.5	12.5	-2.9	-4.6	-17.5
4.5	0.679	-129	2.323	63.1	0.141	-6.4	0.549	-90.3	7.3	11.6	-3.4	-5.2	-17.0
5	0.644	-145.1	2.252	50.5	0.144	-15.4	0.511	-100.9	7.1	10.7	-3.8	-5.8	-16.8
6	0.594	-176.1	2.073	26.9	0.143	-31	0.454	-120.8	6.3	9.2	-4.5	-6.9	-16.9
7	0.565	155	1.885	4.6	0.138	-45.3	0.408	-140.1	5.5	8.0	-5.0	-7.8	-17.2
8	0.536	127	1.715	-16.6	0.126	-58.8	0.344	-157.3	4.7	6.7	-5.4	-9.3	-18.0
9	0.545	99.4	1.611	-37	0.117	-63.7	0.281	-177.8	4.1	6.0	-5.3	-11.0	-18.6
10	0.608	70.4	1.503	-59.7	0.12	-71.8	0.254	145.5	3.5	5.8	-4.3	-11.9	-18.4
11	0.665	46.2	1.332	-82	0.12	-81.5	0.274	106.1	2.5	5.4	-3.5	-11.2	-18.4
12	0.707	27.2	1.167	-101.9	0.119	-90	0.317	75.4	1.3	4.8	-3.0	-10.0	-18.5
13	0.735	8.7	1.03	-121.7	0.12	-99.8	0.356	47.9	0.3	4.2	-2.7	-9.0	-18.4
14	0.76	-9.7	0.904	-142.2	0.122	-110.9	0.421	20.1	-0.9	3.7	-2.4	-7.5	-18.3
15	0.788	-27.4	0.757	-162.1	0.118	-122.8	0.511	-4.1	-2.4	3.1	-2.1	-5.8	-18.6
16	0.802	-42.4	0.609	180	0.115	-134.2	0.6	-21.1	-4.3	2.1	-1.9	-4.4	-18.8
17	0.808	-53.1	0.5	165.7	0.113	-144.3	0.653	-36.7	-6.0	1.0	-1.9	-3.7	-18.9
18	0.845	-64.7	0.429	150.7	0.11	-157.8	0.699	-52.6	-7.4	1.0	-1.5	-3.1	-19.2

Freq (GHz)	Fmin (dB)	GAMMA Mag	OPT Ang	Rn/50	Ga (dB)
0.7	0.88	0.61	16.3	0.45	14.8
0.9	0.87	0.64	22.4	0.43	14.8
1.1	0.9	0.65	28.4	0.44	14.7
1.3	0.92	0.6	33.5	0.43	14.2
1.5	0.95	0.64	37.2	0.42	14.2
1.7	0.95	0.63	40.2	0.41	14
1.9	0.99	0.62	45.4	0.4	13.7
2	1	0.62	47.6	0.4	13.6
2.1	1.02	0.61	49.2	0.4	13.4
2.2	1.03	0.63	50.9	0.39	13.4
2.3	1.03	0.62	53.9	0.38	13.2
2.4	1.04	0.6	55.4	0.37	12.9
2.5	1.04	0.61	57.6	0.37	12.9
3	1.08	0.58	67.9	0.33	12.1
5	1.21	0.49	120	0.14	9.6
6	1.36	0.46	151.2	0.08	8.4

MGA-71543 Typical Scattering Parameters and Noise Parameters

$T_C = 25^\circ\text{C}$, $V_{ds} = 2.3\text{ V}$, $V_{ref} = -0.7\text{ V}$, $I_d = 6\text{ mA}$, $Z_0 = 50\Omega$

Freq (GHz)	S ₁₁ Mag.	S ₁₁ Ang.	S ₂₁ Mag.	S ₂₁ Ang.	S ₁₂ Mag.	S ₁₂ Ang.	S ₂₂ Mag.	S ₂₂ Ang.	S ₂₁ (dB)	G _{max} (dB)	RL _{in} (dB)	RL _{out} (dB)	Isolation (dB)
0.3	0.911	-11	4.164	170.2	0.026	23.5	0.667	-8.4	12.4	22.6	-0.8	-3.5	-31.7
0.5	0.904	-17.7	4.148	163.3	0.03	32.6	0.658	-13.4	12.4	22.2	-0.9	-3.6	-30.5
0.7	0.896	-24.5	4.094	157.1	0.036	38.5	0.656	-18.5	12.2	21.7	-1.0	-3.7	-28.9
0.9	0.887	-31.2	4.029	151.1	0.043	41	0.654	-23.5	12.1	21.2	-1.0	-3.7	-27.3
1.1	0.875	-37.5	3.953	145.2	0.05	41.3	0.648	-28.2	11.9	20.6	-1.2	-3.8	-26.0
1.3	0.864	-43.7	3.877	139.5	0.057	40.4	0.643	-32.6	11.8	20.0	-1.3	-3.8	-24.9
1.5	0.853	-49.7	3.791	134	0.063	38.8	0.638	-36.8	11.6	19.5	-1.4	-3.9	-24.0
1.7	0.84	-55.6	3.723	128.7	0.069	36.7	0.631	-40.7	11.4	18.9	-1.5	-4.0	-23.2
1.9	0.826	-61.2	3.649	123.4	0.075	34.5	0.624	-44.6	11.2	18.4	-1.7	-4.1	-22.5
2	0.82	-64	3.611	121	0.078	33.3	0.619	-46.4	11.2	18.1	-1.7	-4.2	-22.2
2.1	0.812	-66.7	3.576	118.4	0.081	32.1	0.615	-48.2	11.1	17.8	-1.8	-4.2	-21.8
2.2	0.806	-69.4	3.55	115.7	0.084	30.7	0.609	-50.1	11.0	17.6	-1.9	-4.3	-21.5
2.3	0.797	-72.3	3.511	113.3	0.086	29.4	0.604	-51.7	10.9	17.3	-2.0	-4.4	-21.3
2.4	0.787	-74.9	3.474	110.9	0.089	28.1	0.6	-53.5	10.8	16.9	-2.1	-4.4	-21.0
2.5	0.78	-77.8	3.446	108.3	0.091	26.7	0.593	-55.1	10.7	16.7	-2.2	-4.5	-20.8
3	0.738	-91.2	3.309	96.3	0.102	19.7	0.561	-63.7	10.4	15.5	-2.6	-5.0	-19.8
3.5	0.695	-105.2	3.193	84.2	0.112	12.6	0.523	-72.6	10.1	14.3	-3.2	-5.6	-19.0
4	0.649	-120.2	3.072	72.2	0.119	4.9	0.482	-82	9.7	13.3	-3.8	-6.3	-18.5
4.5	0.609	-136.2	2.962	59.9	0.125	-2.6	0.443	-92.3	9.4	12.4	-4.3	-7.1	-18.1
5	0.573	-152.7	2.83	47.8	0.128	-10.4	0.406	-103	9.0	11.5	-4.8	-7.8	-17.9
6	0.529	175.9	2.555	25	0.13	-23.6	0.352	-123	8.1	10.1	-5.5	-9.1	-17.7
7	0.507	147.2	2.295	3.6	0.129	-36	0.308	-142.4	7.2	8.9	-5.9	-10.2	-17.8
8	0.485	119.4	2.072	-16.8	0.123	-47.7	0.247	-159.2	6.3	7.8	-6.3	-12.1	-18.2
9	0.502	92.5	1.922	-36.5	0.123	-52.7	0.189	178.9	5.7	7.1	-6.0	-14.5	-18.2
10	0.574	65	1.78	-58.3	0.132	-63.1	0.174	132.2	5.0	6.9	-4.8	-15.2	-17.6
11	0.639	42.1	1.576	-79.6	0.134	-75	0.218	88.5	4.0	6.4	-3.9	-13.2	-17.5
12	0.686	23.9	1.388	-98.8	0.136	-85.8	0.272	59.8	2.8	5.9	-3.3	-11.3	-17.3
13	0.715	5.8	1.236	-118.1	0.137	-97.7	0.318	34.5	1.8	5.4	-2.9	-10.0	-17.3
14	0.741	-12	1.094	-138.4	0.137	-110.5	0.388	9.3	0.8	4.9	-2.6	-8.2	-17.3
15	0.774	-29.2	0.926	-158	0.131	-123.3	0.482	-11.4	-0.7	4.4	-2.2	-6.3	-17.7
16	0.789	-43.9	0.761	-175.8	0.125	-135.2	0.57	-26.3	-2.4	3.6	-2.1	-4.9	-18.1
17	0.797	-54.3	0.634	169.4	0.121	-145.5	0.622	-40.6	-4.0	2.5	-2.0	-4.1	-18.3
18	0.833	-65.8	0.549	153.8	0.117	-159	0.67	-55.4	-5.2	2.5	-1.6	-3.5	-18.6

Freq (GHz)	Fmin (dB)	GAMMA Mag	OPT Ang	Rn/50	Ga (dB)
0.7	0.71	0.56	15.7	0.32	16.3
0.9	0.74	0.58	21.8	0.3	16.3
1.1	0.76	0.56	28.3	0.31	15.9
1.3	0.79	0.54	33.8	0.3	15.6
1.5	0.81	0.58	36.5	0.29	15.6
1.7	0.8	0.57	40	0.29	15.3
1.9	0.82	0.57	45.2	0.28	15.1
2	0.83	0.56	47.8	0.28	14.9
2.1	0.85	0.55	49.3	0.28	14.7
2.2	0.85	0.58	50.7	0.27	14.8
2.3	0.87	0.56	53.9	0.26	14.5
2.4	0.87	0.54	55.3	0.26	14.3
2.5	0.88	0.55	57.7	0.26	14.2
3	0.9	0.53	67.7	0.23	13.5
5	1.03	0.42	120.7	0.11	10.7
6	1.14	0.38	152.7	0.07	9.4

MGA-71543 Typical Scattering Parameters and Noise Parameters

$T_C = 25^\circ\text{C}$, $V_{ds} = 2.4\text{ V}$, $V_{ref} = -0.6\text{ V}$, $I_d = 10\text{ mA}$, $Z_0 = 50\Omega$

Freq (GHz)	S ₁₁ Mag.	S ₁₁ Ang.	S ₂₁ Mag.	S ₂₁ Ang.	S ₁₂ Mag.	S ₁₂ Ang.	S ₂₂ Mag.	S ₂₂ Ang.	S ₂₁ (dB)	G _{max} (dB)	RL _{in} (dB)	RL _{out} (dB)	Isolation (dB)
0.3	0.9	-11.5	5.023	169.8	0.024	23.3	0.608	-8.7	14.0	23.2	-0.9	-4.3	-32.4
0.5	0.892	-18.6	4.993	162.7	0.029	32.4	0.599	-13.8	14.0	22.8	-1.0	-4.5	-30.8
0.7	0.884	-25.7	4.919	156.3	0.034	38.3	0.597	-19.1	13.8	22.4	-1.1	-4.5	-29.4
0.9	0.873	-32.7	4.83	150	0.041	40.9	0.595	-24.2	13.7	21.8	-1.2	-4.5	-27.7
1.1	0.859	-39.4	4.728	143.9	0.047	41.3	0.589	-29.1	13.5	21.2	-1.3	-4.6	-26.6
1.3	0.845	-45.8	4.623	138	0.053	40.5	0.584	-33.6	13.3	20.5	-1.5	-4.7	-25.5
1.5	0.832	-52	4.509	132.4	0.059	39.1	0.578	-37.8	13.1	20.0	-1.6	-4.8	-24.6
1.7	0.816	-58.1	4.412	126.9	0.065	37.2	0.571	-41.8	12.9	19.4	-1.8	-4.9	-23.7
1.9	0.801	-63.9	4.312	121.5	0.07	35	0.563	-45.7	12.7	18.8	-1.9	-5.0	-23.1
2	0.793	-66.8	4.259	119	0.073	33.9	0.558	-47.4	12.6	18.5	-2.0	-5.1	-22.7
2.1	0.784	-69.6	4.211	116.4	0.075	32.7	0.553	-49.2	12.5	18.2	-2.1	-5.1	-22.5
2.2	0.776	-72.4	4.171	113.7	0.078	31.6	0.549	-51	12.4	18.0	-2.2	-5.2	-22.2
2.3	0.767	-75.3	4.117	111.2	0.08	30.3	0.543	-52.7	12.3	17.7	-2.3	-5.3	-21.9
2.4	0.757	-78	4.07	108.7	0.083	29	0.538	-54.5	12.2	17.4	-2.4	-5.4	-21.6
2.5	0.749	-80.9	4.029	106.2	0.085	27.7	0.531	-56	12.1	17.1	-2.5	-5.5	-21.4
3	0.701	-94.7	3.829	94	0.095	21.2	0.499	-64.4	11.7	15.8	-3.1	-6.0	-20.4
3.5	0.655	-108.9	3.659	81.9	0.103	14.7	0.461	-73.1	11.3	14.7	-3.7	-6.7	-19.7
4	0.607	-124.2	3.49	70	0.11	7.6	0.42	-82.2	10.9	13.7	-4.3	-7.5	-19.2
4.5	0.567	-140.4	3.335	58	0.116	0.8	0.382	-92.6	10.5	12.8	-4.9	-8.4	-18.7
5	0.533	-157.2	3.163	46.1	0.12	-6.3	0.346	-103.3	10.0	12.0	-5.5	-9.2	-18.4
6	0.493	171.3	2.828	23.9	0.124	-18.3	0.296	-123.4	9.0	10.6	-6.1	-10.6	-18.1
7	0.476	142.7	2.526	2.9	0.126	-30.1	0.255	-143.1	8.0	9.5	-6.4	-11.9	-18.0
8	0.458	115.1	2.271	-17	0.124	-41.4	0.195	-159.7	7.1	8.3	-6.8	-14.2	-18.1
9	0.48	88.8	2.094	-36.3	0.128	-47.3	0.141	176.8	6.4	7.6	-6.4	-17.0	-17.9
10	0.558	62.2	1.935	-57.6	0.139	-58.9	0.14	120.6	5.7	7.4	-5.1	-17.1	-17.1
11	0.627	39.9	1.712	-78.3	0.142	-71.7	0.2	76.5	4.7	7.0	-4.1	-14.0	-17.0
12	0.675	22.1	1.512	-97.2	0.145	-83.5	0.26	50.1	3.6	6.5	-3.4	-11.7	-16.8
13	0.706	4.4	1.351	-116.2	0.145	-96.3	0.308	26.4	2.6	6.0	-3.0	-10.2	-16.8
14	0.732	-13.3	1.2	-136.2	0.145	-109.7	0.379	3.1	1.6	5.6	-2.7	-8.4	-16.8
15	0.767	-30.2	1.022	-155.6	0.137	-123.1	0.473	-15.8	0.2	5.1	-2.3	-6.5	-17.3
16	0.783	-44.7	0.849	-173.3	0.131	-135.2	0.558	-29.5	-1.4	4.3	-2.1	-5.1	-17.7
17	0.792	-55.1	0.713	171.8	0.126	-145.7	0.609	-43	-2.9	3.4	-2.0	-4.3	-18.0
18	0.828	-66.5	0.622	156	0.122	-159.2	0.656	-57.3	-4.1	3.3	-1.6	-3.7	-18.3

Freq (GHz)	Fmin (dB)	GAMMA Mag	OPT Ang	Rn/50	Ga (dB)
0.7	0.63	0.53	15.3	0.27	17.2
0.9	0.66	0.54	21.4	0.26	17.1
1.1	0.68	0.55	28.5	0.26	16.9
1.3	0.7	0.52	33.8	0.25	16.5
1.5	0.72	0.55	37	0.25	16.4
1.7	0.72	0.56	39.9	0.25	16.2
1.9	0.73	0.53	45.5	0.24	15.8
2	0.74	0.53	48.3	0.23	15.6
2.1	0.76	0.52	49.6	0.23	15.4
2.2	0.78	0.54	50.7	0.23	15.4
2.3	0.78	0.53	54	0.22	15.2
2.4	0.79	0.51	55.6	0.22	15
2.5	0.8	0.52	57.6	0.22	14.9
3	0.82	0.5	67.5	0.2	14.2
5	0.94	0.38	121.3	0.1	11.2
6	1.05	0.34	155	0.07	10

MGA-71543 Typical Scattering Parameters and Noise Parameters

$T_C = 25^\circ\text{C}$, $V_{ds} = 2.5\text{ V}$, $V_{ref} = -0.5\text{ V}$, $I_d = 20\text{ mA}$, $Z_0 = 50\Omega$

Freq (GHz)	S ₁₁ Mag.	S ₁₁ Ang.	S ₂₁ Mag.	S ₂₁ Ang.	S ₁₂ Mag.	S ₁₂ Ang.	S ₂₂ Mag.	S ₂₂ Ang.	S ₂₁ (dB)	G _{max} (dB)	RL _{in} (dB)	RL _{out} (dB)	Isolation (dB)
0.3	0.889	-12.1	5.952	169.3	0.023	22.8	0.541	-9	15.5	23.8	-1.0	-5.3	-32.8
0.5	0.88	-19.5	5.901	162	0.027	32	0.532	-14.1	15.4	23.3	-1.1	-5.5	-31.4
0.7	0.87	-27	5.803	155.3	0.032	38.2	0.531	-19.6	15.3	22.9	-1.2	-5.5	-29.9
0.9	0.858	-34.3	5.684	148.8	0.037	40.9	0.528	-24.7	15.1	22.3	-1.3	-5.5	-28.6
1.1	0.842	-41.2	5.548	142.5	0.043	41.5	0.523	-29.7	14.9	21.6	-1.5	-5.6	-27.3
1.3	0.826	-47.9	5.407	136.5	0.049	40.9	0.518	-34.2	14.7	21.0	-1.7	-5.7	-26.2
1.5	0.81	-54.3	5.26	130.6	0.055	39.6	0.511	-38.4	14.4	20.4	-1.8	-5.8	-25.2
1.7	0.792	-60.7	5.126	125	0.06	38	0.505	-42.4	14.2	19.8	-2.0	-5.9	-24.4
1.9	0.774	-66.6	4.99	119.5	0.065	36.1	0.497	-46.2	14.0	19.2	-2.2	-6.1	-23.7
2	0.765	-69.6	4.922	116.9	0.067	35	0.493	-47.9	13.8	18.9	-2.3	-6.1	-23.5
2.1	0.755	-72.5	4.857	114.3	0.069	34	0.488	-49.6	13.7	18.6	-2.4	-6.2	-23.2
2.2	0.746	-75.4	4.797	111.5	0.072	32.9	0.483	-51.5	13.6	18.3	-2.5	-6.3	-22.9
2.3	0.736	-78.3	4.729	109	0.074	31.8	0.477	-53	13.5	18.0	-2.7	-6.4	-22.6
2.4	0.724	-81	4.668	106.5	0.076	30.6	0.473	-54.7	13.4	17.7	-2.8	-6.5	-22.4
2.5	0.716	-84	4.612	103.9	0.078	29.4	0.467	-56.2	13.3	17.5	-2.9	-6.6	-22.2
3	0.664	-98	4.34	91.7	0.087	23.6	0.435	-64.1	12.7	16.2	-3.6	-7.2	-21.2
3.5	0.616	-112.4	4.107	79.7	0.095	17.8	0.399	-72.4	12.3	15.1	-4.2	-8.0	-20.4
4	0.566	-128	3.886	67.9	0.102	11.3	0.36	-81.1	11.8	14.1	-4.9	-8.9	-19.8
4.5	0.528	-144.5	3.686	56.1	0.108	5.1	0.324	-91.4	11.3	13.2	-5.5	-9.8	-19.3
5	0.495	-161.5	3.473	44.5	0.113	-1.3	0.291	-102.1	10.8	12.4	-6.1	-10.7	-18.9
6	0.46	166.9	3.078	22.8	0.119	-12.5	0.245	-122.3	9.8	11.1	-6.7	-12.2	-18.5
7	0.448	138.5	2.737	2.4	0.124	-24.1	0.208	-142.5	8.7	9.9	-7.0	-13.6	-18.1
8	0.436	111.1	2.452	-17.1	0.125	-35.3	0.15	-158.6	7.8	8.8	-7.2	-16.5	-18.1
9	0.462	85.4	2.252	-36	0.133	-42.2	0.099	175.9	7.1	8.1	-6.7	-20.1	-17.5
10	0.544	59.7	2.075	-56.8	0.146	-54.9	0.114	106.8	6.3	7.9	-5.3	-18.9	-16.7
11	0.617	38.1	1.836	-77.2	0.15	-68.5	0.191	65.3	5.3	7.5	-4.2	-14.4	-16.5
12	0.668	20.6	1.626	-95.6	0.153	-81	0.256	41.5	4.2	7.1	-3.5	-11.8	-16.3
13	0.7	3.1	1.457	-114.4	0.153	-94.4	0.305	19.4	3.3	6.6	-3.1	-10.3	-16.3
14	0.728	-14.4	1.299	-134.1	0.153	-108.4	0.377	-2.4	2.3	6.2	-2.8	-8.5	-16.3
15	0.763	-31.2	1.111	-153.3	0.144	-122.2	0.469	-19.6	0.9	5.8	-2.3	-6.6	-16.8
16	0.78	-45.5	0.93	-170.8	0.137	-134.6	0.552	-32.5	-0.6	5.0	-2.2	-5.2	-17.3
17	0.789	-55.8	0.788	174.2	0.132	-145.3	0.599	-45.4	-2.1	4.1	-2.1	-4.5	-17.6
18	0.825	-67.1	0.691	158.3	0.126	-159	0.645	-59	-3.2	4.1	-1.7	-3.8	-18.0

Freq (GHz)	Fmin (dB)	GAMMA Mag	OPT Ang	Rn/50	Ga (dB)
0.7	0.59	0.52	15.7	0.25	18.1
0.9	0.64	0.53	21.7	0.24	17.9
1.1	0.66	0.53	28.9	0.24	17.7
1.3	0.68	0.51	34.2	0.23	17.3
1.5	0.68	0.54	38.5	0.23	17.2
1.7	0.69	0.54	40.8	0.23	17
1.9	0.72	0.51	46.4	0.22	16.5
2	0.73	0.51	48.8	0.22	16.4
2.1	0.74	0.5	50.5	0.21	16.2
2.2	0.75	0.51	52.4	0.21	16.1
2.3	0.76	0.51	55.4	0.2	15.9
2.4	0.77	0.48	56.3	0.2	15.6
2.5	0.79	0.5	59	0.2	15.6
3	0.82	0.47	68.6	0.18	14.7
5	0.93	0.34	125.1	0.09	11.7
6	1.06	0.31	160.6	0.07	10.5

MGA-71543 Typical Scattering Parameters and Noise Parameters

$T_C = 25^\circ\text{C}$, $V_{ds} = 2.7\text{ V}$, $V_{ref} = -0.3\text{ V}$, $I_d = 40\text{ mA}$, $Z_0 = 50\Omega$

Freq (GHz)	S ₁₁ Mag.	S ₁₁ Ang.	S ₂₁ Mag.	S ₂₁ Ang.	S ₁₂ Mag.	S ₁₂ Ang.	S ₂₂ Mag.	S ₂₂ Ang.	S ₂₁ (dB)	G _{max} (dB)	RL _{in} (dB)	RL _{out} (dB)	Isolation (dB)
0.3	0.889	-12.3	6.174	169.2	0.022	22.3	0.508	-8.9	15.8	23.9	-1.0	-5.9	-33.2
0.5	0.88	-19.8	6.117	161.8	0.025	31.6	0.501	-13.7	15.7	23.5	-1.1	-6.0	-32.0
0.7	0.87	-27.4	6.012	155.1	0.029	37.9	0.499	-19.1	15.6	23.0	-1.2	-6.0	-30.8
0.9	0.857	-34.9	5.885	148.5	0.035	40.9	0.497	-24.2	15.4	22.4	-1.3	-6.1	-29.1
1.1	0.841	-41.9	5.74	142.1	0.04	41.7	0.493	-29	15.2	21.7	-1.5	-6.1	-28.0
1.3	0.823	-48.7	5.589	136	0.046	41.4	0.488	-33.4	14.9	21.0	-1.7	-6.2	-26.7
1.5	0.807	-55.2	5.435	130.2	0.051	40.2	0.483	-37.5	14.7	20.4	-1.9	-6.3	-25.8
1.7	0.788	-61.6	5.289	124.5	0.055	38.7	0.477	-41.3	14.5	19.8	-2.1	-6.4	-25.2
1.9	0.769	-67.6	5.145	119	0.06	37	0.47	-45	14.2	19.2	-2.3	-6.6	-24.4
2	0.76	-70.6	5.072	116.3	0.062	36.1	0.466	-46.5	14.1	18.9	-2.4	-6.6	-24.2
2.1	0.75	-73.5	5.003	113.7	0.064	35.1	0.462	-48.2	14.0	18.6	-2.5	-6.7	-23.9
2.2	0.739	-76.3	4.93	111	0.066	34.2	0.458	-50	13.9	18.3	-2.6	-6.8	-23.6
2.3	0.73	-79.4	4.865	108.4	0.068	33.1	0.452	-51.4	13.7	18.0	-2.7	-6.9	-23.3
2.4	0.718	-82.2	4.801	105.9	0.07	32	0.448	-53	13.6	17.7	-2.9	-7.0	-23.1
2.5	0.709	-85.2	4.739	103.3	0.072	30.9	0.442	-54.5	13.5	17.5	-3.0	-7.1	-22.9
3	0.656	-99.3	4.447	91	0.081	25.5	0.413	-61.9	13.0	16.2	-3.7	-7.7	-21.8
3.5	0.608	-113.8	4.197	79	0.089	20	0.38	-69.7	12.5	15.1	-4.3	-8.4	-21.0
4	0.559	-129.5	3.963	67.3	0.095	14	0.344	-77.9	12.0	14.1	-5.1	-9.3	-20.4
4.5	0.521	-146	3.751	55.6	0.101	8.2	0.31	-87.7	11.5	13.3	-5.7	-10.2	-19.9
5	0.49	-163	3.53	44.1	0.106	2	0.278	-98	11.0	12.5	-6.2	-11.1	-19.5
6	0.457	-165.4	3.124	22.5	0.114	-8.6	0.236	-117.5	9.9	11.2	-6.8	-12.5	-18.9
7	0.447	137.1	2.776	2.2	0.12	-19.8	0.201	-137.1	8.9	10.0	-7.0	-13.9	-18.4
8	0.436	109.8	2.484	-17.2	0.122	-30.9	0.146	-151.4	7.9	8.9	-7.2	-16.7	-18.3
9	0.462	84.5	2.28	-36	0.132	-37.8	0.096	-173.8	7.2	8.2	-6.7	-20.4	-17.6
10	0.546	59.1	2.102	-56.7	0.146	-50.8	0.101	112	6.5	8.0	-5.3	-19.9	-16.7
11	0.621	37.8	1.861	-77	0.152	-64.7	0.177	66.8	5.4	7.6	-4.1	-15.0	-16.4
12	0.672	20.3	1.649	-95.4	0.155	-77.6	0.244	42.3	4.3	7.2	-3.5	-12.3	-16.2
13	0.705	2.9	1.478	-114.1	0.157	-91.3	0.293	19.8	3.4	6.8	-3.0	-10.7	-16.1
14	0.733	-14.6	1.32	-133.9	0.157	-105.8	0.366	-2.2	2.4	6.4	-2.7	-8.7	-16.1
15	0.768	-31.3	1.129	-153.1	0.149	-119.7	0.461	-19.1	1.1	6.0	-2.3	-6.7	-16.5
16	0.786	-45.7	0.946	-170.6	0.141	-132.5	0.545	-32.1	-0.5	5.2	-2.1	-5.3	-17.0
17	0.794	-56.1	0.801	174.5	0.136	-143.6	0.595	-45.1	-1.9	4.3	-2.0	-4.5	-17.3
18	0.83	-67.4	0.703	158.5	0.131	-157.4	0.641	-58.8	-3.1	4.3	-1.6	-3.9	-17.7

Freq (GHz)	Fmin (dB)	GAMMA Mag	OPT Ang	Rn/50	Ga (dB)
0.7	0.69	0.56	17.3	0.32	18.5
0.9	0.73	0.57	23.9	0.3	18.3
1.1	0.73	0.56	30.8	0.31	18
1.3	0.77	0.54	36.5	0.3	17.6
1.5	0.77	0.58	40.7	0.29	17.6
1.7	0.8	0.57	43.9	0.29	17.3
1.9	0.83	0.55	49.7	0.28	16.9
2	0.85	0.54	52.1	0.27	16.7
2.1	0.86	0.54	54.3	0.27	16.5
2.2	0.9	0.54	55.5	0.26	16.4
2.3	0.91	0.54	59.3	0.26	16.2
2.4	0.91	0.52	61	0.25	16
2.5	0.93	0.52	63.2	0.25	15.8
3	0.98	0.49	74.7	0.22	15
5	1.19	0.37	136	0.1	11.9
6	1.35	0.35	172.8	0.08	10.7

Part Number Ordering Information

Part Number	No. of Devices	Container
MGA-71543-TR1G	3000	7" Reel
MGA-71543-TR2G	10000	13" Reel
MGA-71543-BLKG	100	Antistatic bag

Package Dimensions Outline 43 SOT-343 (SC70 4-lead)

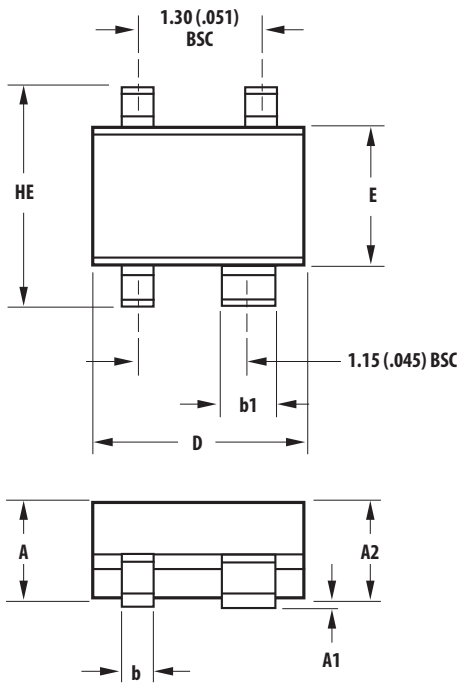

SYMBOL	DIMENSIONS (mm)	
	MIN.	MAX.
E	1.15	1.35
D	1.85	2.25
HE	1.80	2.40
A	0.80	1.10
A2	0.80	1.00
A1	0.00	0.10
b	0.15	0.40
b1	0.55	0.70
c	0.10	0.20
L	0.10	0.46

Recommended PCB Pad Layout for Avago's SC70 4L/SOT-343 Products

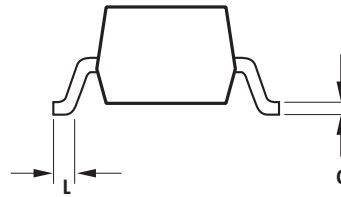
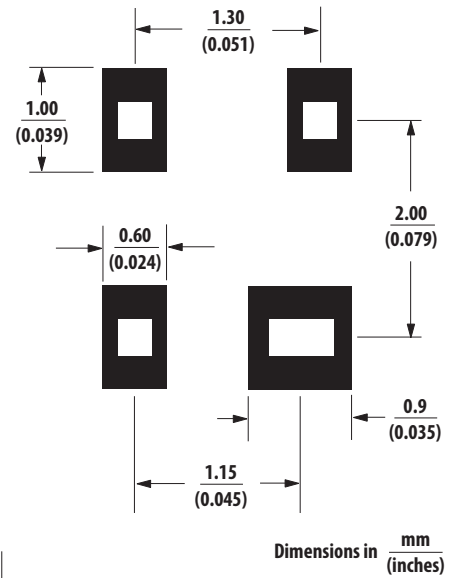

NOTES:

1. All dimensions are in mm.
2. Dimensions are inclusive of plating.
3. Dimensions are exclusive of mold flash & metal burr.
4. All specifications comply to EIAJ SC70.
5. Die is facing up for mold and facing down for trim/form, ie: reverse trim/form.
6. Package surface to be mirror finish.

Device Orientation

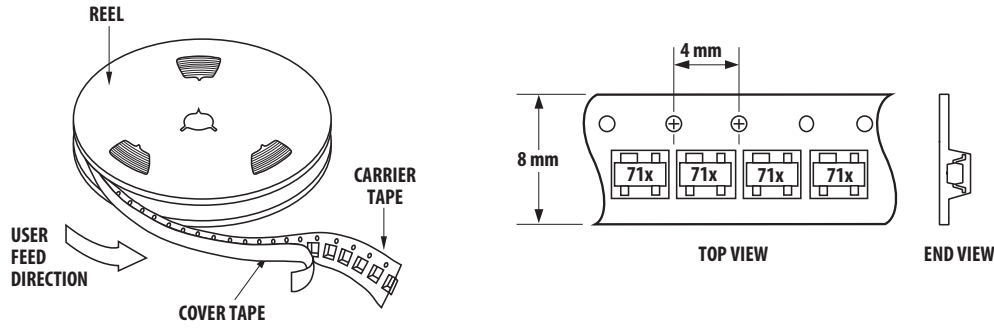

Tape Dimensions for Outline 4T

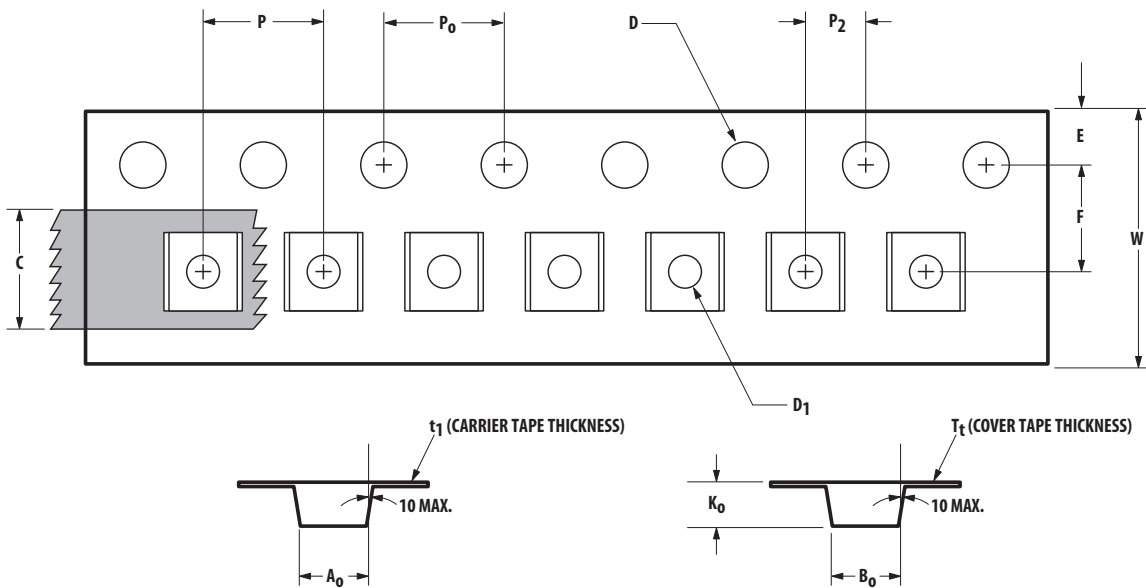

	DESCRIPTION	SYMBOL	SIZE (mm)	SIZE (INCHES)
CAVITY	LENGTH	A ₀	2.40 ± 0.10	0.094 ± 0.004
	WIDTH	B ₀	2.40 ± 0.10	0.094 ± 0.004
	DEPTH	K ₀	1.20 ± 0.10	0.047 ± 0.004
	PITCH	P	4.00 ± 0.10	0.157 ± 0.004
	BOTTOM HOLE DIAMETER	D ₁	1.00 ± 0.25	0.039 ± 0.010
PERFORATION	DIAMETER	D	1.55 ± 0.10	0.061 ± 0.002
	PITCH	P ₀	4.00 ± 0.10	0.157 ± 0.004
	POSITION	E	1.75 ± 0.10	0.069 ± 0.004
CARRIER TAPE	WIDTH	W	8.00 + 0.30 - 0.10	0.315 + 0.012
	THICKNESS	t ₁	0.254 ± 0.02	0.0100 ± 0.0008
COVER TAPE	WIDTH	C	5.40 ± 0.10	0.205 ± 0.004
	TAPE THICKNESS	T _t	0.062 ± 0.001	0.0025 ± 0.0004
DISTANCE	CAVITY TO PERFORATION (WIDTH DIRECTION)	F	3.50 ± 0.05	0.138 ± 0.002
	CAVITY TO PERFORATION (LENGTH DIRECTION)	P ₂	2.00 ± 0.05	0.079 ± 0.002

Designing with MGA-71543, a Low Noise Amplifier with Built-in Mitigated Bypass Switches

Introduction

The MGA-71543 is a single stage GaAs RFIC low noise amplifier with an integrated bypass switch (Figure 1).

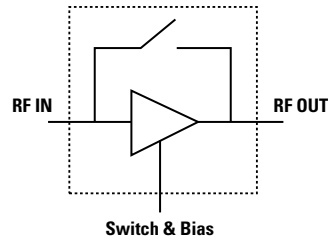

Figure 1. MGA-71543 Functional Diagram.

This application note describes a low noise amplifier design using Avago Technologies' MGA-71543.

The MGA-71543 is designed for receivers and transmitters operating from 100 MHz to 6 GHz, mainly for CDMA applications i.e. IS-95 CDMA1900, CDMA800 and W-CDMA. It can be used as a first stage (Q1) in a CDMA PCS 1900 MHz application currently filled by a single transistor. Its bypass capability adds features over the single transistor solution with no performance loss. The device can also be used as a driver amplifier for CDMA800.

The purpose of the switch feature is to prevent distortion of high signal levels in receiver applications by bypassing the amplifier. Furthermore, zero current draw, when in bypass mode, saves current thus improving battery life.

The internally matched switching circuit provides a 20 dB gain step and also reduces gain ripple and mismatch in system usage.

The MGA-71543 is a small LNA/Bypass Switch MMIC that provides a low noise figure, a high gain and high third order input intercept point (IIP3) ideal for the first stage LNA of PCS CDMA and W-CDMA.

Device Description

The MGA-71543 is a single stage GaAs IC with a built-in bypass switch housed in a SOT-343 package. The device diagram is shown in Figures 1 and 2.

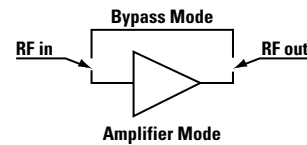

Figure 2. Simplified Schematic.

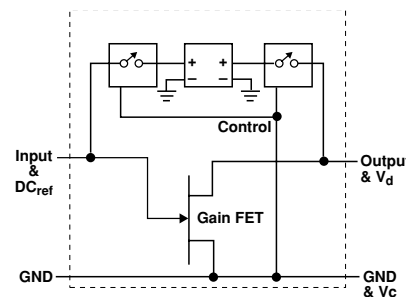

Figure 3. Bypass State Duplicates the In and Out Impedance.

The MGA-71543 features a minimum noise figure of 0.8 dB and 16 dB available gain. The input and output are partially matched, and only a simple series/shunt inductor match is required to achieve low noise figure and VSWR into 50Ω.

When set into the bypass mode, both input and output are internally matched through a mitigative circuit. This circuit draws no current (less than 2 μA), yet duplicates the in and out impedance of the LNA (Figure 3). This allows the system user to have minimum mismatch change from LNA to Bypass mode, thus allow-

ing the same matching network at both states (LNA State and Bypass State). This makes the MGA-71543 ideal for use between duplexers and image reject filters.

The MGA-71543 offers an integrated solution of LNA with adjustable IIP3. The IIP3 can be fixed to a desired current level for the receiver's linearity requirements. The LNA has a bypass switch function, which sets the current to zero (2 μA) and provides low insertion loss when in bypass mode. The bypass mode also boosts dynamic range when high level signal is being received.

Many CDMA systems operate 20% LNA and 80% bypass mode. For example, with the bypass draw of zero and LNA of 10 mA, the MGA-71543 allows an average of only 2 mA current.

The MGA-71543 is a GaAs MMIC, processed on Avago's cost effective PHEMT (Pseudomorphic High Electron Mobility Transistor Technology). It is housed in the SOT343 (SC70 4-lead) package.

Biasing

This IC can be biased like a depletion mode discrete GaAsFET. Two kinds of passive biasing can be used: gate bias (Figure 4) and source resistor bias method (Figure 6).

Gate Bias

Pins 1 and 4 (Figure 4) are DC grounded and a negative bias voltage is applied to Pin 3 in addition to the power supply (2.7 or 3V) applied to Pin 2. This method of biasing has the advantage of minimizing parasitic source inductance because the device is directly DC and RF grounded.

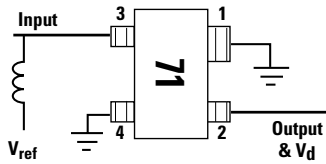

Figure 4. Gate Bias Method.

The DC supply at the input terminal (V_{ref}) can be applied through a RF choke (inductor).

The voltage at V_{ref} (Pin 3) with respect to ground determines the device current, I_d . A plot of typical I_d vs. V_{ref} is shown in Figure 5. Maximum device current (approximately 60 mA) occurs at $V_{ref} = 0$ (i.e. $V_{gs} = 0$).

When using the gate biasing method, the bypass mode is activated when $V_{ds} = 0V$ and $V_{ref} < -2V$.

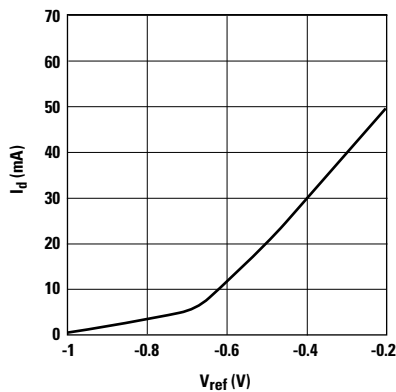

Figure 5. Device Current vs. V_{ref} .

This kind of biasing would not usually be used unless a negative supply voltage was readily available.

Source Resistor Bias

This is the recommended method because it only requires one (positive) power supply. As shown in Figure 6, Pin 3 is DC grounded and pins 1 and 4 are RF bypassed.

The current of the amplifier (I_d) is set by the value of the resistor R_{bias} . This resistor (R_{bias}) is connected at Pin 4 as shown in Figure 6 and RF bypassed. At least two capacitors in parallel are recommended for RF bypassing. One capacitor (100 pF) for high frequency bypassing and a second, large value capacitor for better low frequency bypassing. The large value capacitor is added in parallel to improve the IP3 because they help ground the low frequency mixing terms that are generated during a two tones test (i.e. $f_1 - f_2$ term which is the separation of the two tones usually 1 to a few MHz) and thus improve the IIP3.

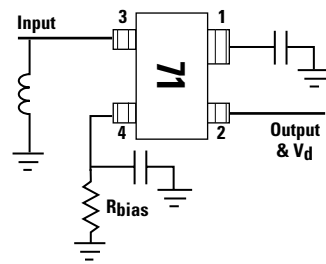

Figure 6. Source Resistor Bias Method.

Maximum current (about 60 mA) occurs when $R_{bias} = 0$.

A plot of typical I_d vs. R_{bias} is shown in Figure 7.

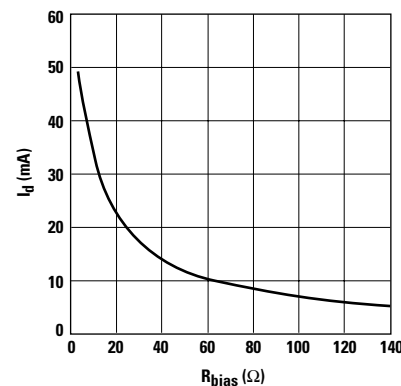

Figure 7. Device Current vs. R_{bias} .

The approximate value of the external resistor, R_{bias} , may also be calculated from:

$$R_{bias} = \frac{964}{I_d} (1 - 0.112 \sqrt{I_d})$$

where R_{bias} is in ohms and I_d is the desired device current in mA.

A simple method for DC grounding the input terminal (Pin 3) is to use a shunt inductor that is also part of the noise-matching network.

Adaptive Biasing

For applications in which input power levels vary over a wide range, it may be useful to dynamically adapt the bias of the MGA-71543 to match the signal level. A sensor senses the signal level at some point in the system (usually in the baseband circuitry) and automatically adjusts the bias current of the amplifier accordingly. The main advantage of adaptive biasing is conservation of supply current (longer battery life) by using only the amount of current necessary to handle the input signal without distortion.

Adaptive biasing of the MGA-71543 can be accomplished by simple digital means (Figure 8). For instance simple electronic switches can be used to control the value of the source resistor in discrete increment.

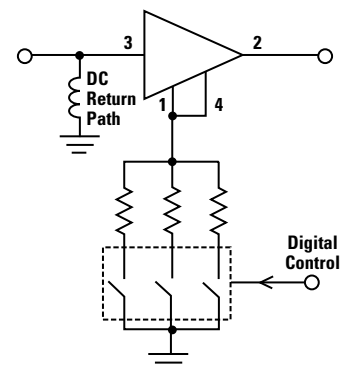

Figure 8. Adaptive Bias Control using Digital Method.

Applying the Device Voltage

Common to all methods of biasing, voltage V_d is applied to the MGA-71543 through the RF output connection (Pin 2). The bias line is capacitively bypassed to keep RF from the DC supply lines and prevent resonant dips or peaks in the response of the amplifier. Where practical, it may be cost effective to use a length of high impedance transmission line (usually $\lambda/4$ line) in place of the RFC.

When using the *gate bias method*, the applied device voltage, V_{ds} , is equal to voltage V_d (at pin 2) since V_s is zero.

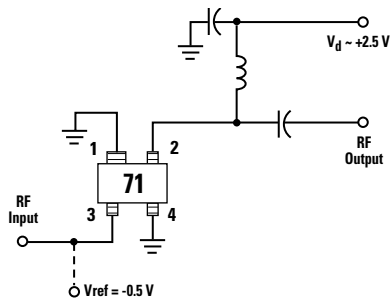

Figure 9. DC Schematic for Gate Bias.

For *source resistor biasing method*, the applied device voltage, V_{ds} , is $V_d - V_s$. The bias control voltage is V_s (Pin 4) which is set by the external bias resistor. A source resistor bias circuit is shown in Figure 10.

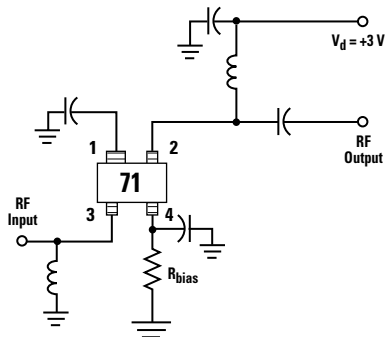

Figure 10. DC Schematic for Source Bias.

Controlling the Switch

The device current controls the state of the MGA-71543 (amplifier or bypass mode). For device currents greater than 3 mA, it functions as an amplifier. If a lower current is drawn, the gain of the amplifier is significantly reduced and the performance will degrade. If the device current is set to zero, the MGA-71543 is switched into a bypass mode in which the signal is routed around the amplifier with a loss of about 5.6 dB.

The simplest way of switching the MGA-71543 to the bypass mode is to open-circuit the terminals at Pins 1 and 4. The bypass mode is also set by increasing the source resistance R_{bias} to greater than 1 M Ω . With the DC ground connection open, the internal control circuit of the MGA-71543 auto-switches from amplifier mode into a bypass mode and the device current drops to near zero. Typical bypass mode current is 2 μ A.

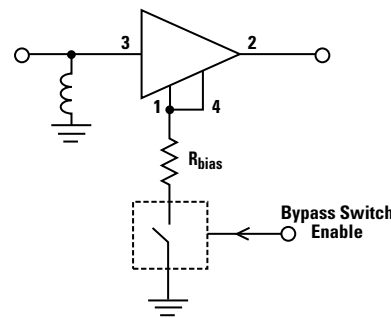

Figure 11. MGA-71543 Amplifier/Bypass State Switching.

A digital switch can be used to control the amplifier and Bypass State as shown in Figure 11.

Switching Speed

The speed at which the MGA-71543 switches between states is extremely fast. The intrinsic switching speed is typically around 10 ns. However in practical circuits, the switching speed is limited by the time

constants of the external bias circuit components (current setting resistor and bypass capacitors). These external components increase the switching time to around 100ns. Furthermore, the switching ON time is slightly lower (faster) than the switching OFF time (i.e. It switches on faster).

Thermal issues

The Mean Time To Failure (MTTF) of semiconductors is inversely proportional to the operating temperature.

When biased at 3V and 10 mA for LNA applications, the power dissipation is $3V \times 10 \text{ mA} = 30 \text{ mW}$. The temperature increment from the RFIC channel to its case is then $30 \text{ mW} \times \theta_{jc} = 0.030 \text{ watt} \times 240^\circ\text{C/watt} = 7.2^\circ\text{C}$. Subtracting the channel-to-case temperature rise from the suggested maximum junction temperature of 150°C , the resulting maximum allowable case temperature is 143°C .

The worst case thermal situation occurs when the MGA-71543 is operated at its maximum operating conditions in an effort to maximize output power or achieve minimum distortion. A similar calculation for the maximum operating bias of 4.2 volts and 50 mA yields a maximum allowable case temperature of 100°C . (i.e. $210 \text{ mW} \times \theta_{jc} = 0.210 \text{ watt} \times 240^\circ\text{C/watt} = 50.4^\circ\text{C}$, $150^\circ\text{C} - 50.4^\circ\text{C} = 100^\circ\text{C}$.)

This calculation assumes the worst case of no RF power being extracted from the device. When operated in a saturated mode, both power-added efficiency and the maximum allowable case temperature will increase.

Note: "Case" temperature for surface mount packages such as the SOT-343 refers to the interface between the package pins and the

mounting surface, i.e., the temperature at the PCB mounting pads. The primary heat path from the RFIC chip to the system heatsink is by means of conduction through the package leads and ground vias to the ground plane of the PCB.

Grounding Consideration in PCB Layout

The MGA-71543 requires careful attention during grounding. Any device with gain can be made to oscillate if feedback is added. Since poor grounding adds series feedback, it can cause the device to oscillate. Poor grounding is one of the most common causes of oscillation in RF components. Careful attention should be used when RF bypassing the ground terminals when the device is biased using the source resistor method.

Package Footprint

The PCB pad print for the miniature, 4-lead SOT-343 (SC70) package is shown in Figure 12.

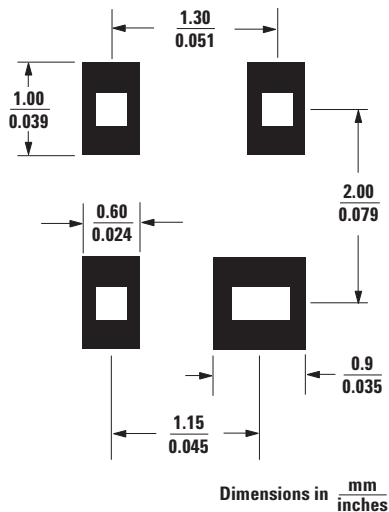

Figure 12. Recommended PCB Pad Layout for Avago's SC70 4L/SOT-343 Products.

The layout is shown with a footprint of the MGA-71543 superimposed on the PCB pads for reference.

RF bypass

For layouts using the source resistor method of biasing, both of the ground terminals of the MGA-71543 must be well bypassed to maintain device stability. Beginning with the package pad print in Figure 12, and RF layout similar to the one shown in Figure 13 is a good starting point for using the MGA-71543 with capacitor-bypassed ground terminals. It is a best practice to use multiple vias to minimize overall ground path inductance.

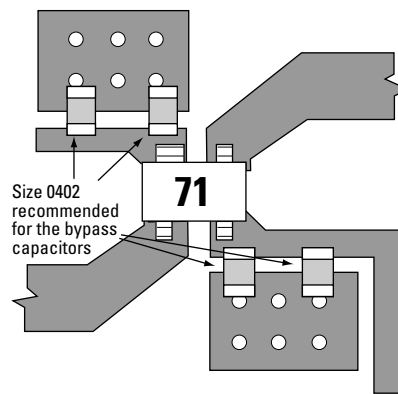

Figure 13. Layout for RF Bypass.

PCB Materials

0.031 inches thick of FR-4 or G-10 type dielectric materials are typical choices for most low cost wireless applications using single layer printed boards. As an alternative, a Getek material with a multilayer printed circuit board can be used for a smaller size board, where:

- 1st layer: RF routing layer
- 2nd layer: Ground layer
- 3rd layer: Power (DC) routing layer
- 4th layer: Other RF routing layer

The spacing between the layers is as follows:

- Between the 1st and 2nd: 0.005"
- Between the 2nd and 3rd: 0.020"
- Between the 3rd and 4th: 0.005"

LNA Application

In the following sections the LNA design is described in a more general way. Sample evaluation boards for 1900 MHz and 800 MHz are shown in a table (Table 1) and the appropriate board diagram is shown (Figures 22 and 23). A second smaller size board is also shown (Figures 25 and 26) with the corresponding table (Table 2). The smaller board is an example of reducing the size of the layout, more suitable for handset manufacturers. For low noise amplifier application, the LNA is typically biased 6 to 20 mA.

The MGA-71543 is a conditionally stable device, therefore, the proper input and output loads must be presented in addition to properly RF grounding the device. Please refer to the stability section for tips on preventing oscillation. The LNA can be switched ON or OFF by a simply varying the resistor to its ground leads as described in previous sections.

Matching Networks for the LNA

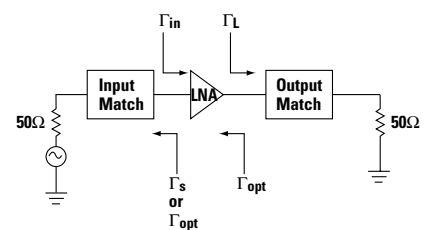

Figure 14. Input and Output Matching Terminology.

The input matching network determines the noise figure and return loss (S11) of our amplifier. The output-matching network determines the IP3 and output return loss (S22). Furthermore, both input and output matching networks influence the gain. The best gain (Maximum Available Gain-MAG) and lowest input return loss is obtained when both the input and output are conju-

gately matched to 50Ω. For instance at the input, when $\Gamma_s = \Gamma_{in}^*$ the highest gain with the best power transfer is obtained where Γ_s is the source reflection coefficient presented to the input pin.

For best noise, $\Gamma_s = \Gamma_{OPT}$, where Γ_{OPT} is the source reflection coefficient for optimum NF match and is determined empirically (experimentally). However, an input match where $\Gamma_s = \Gamma_{OPT}$ does not necessarily yield the best return loss nor the best gain.

Input Match

To allow flexibility for the designer, the LNA is intended to be used with external matching network at the input.

The noise performance of a two port can be determined if the values of the noise parameters F_{min} , $r_n = R_n/50$ and Γ_{OPT} are known (shown in the datasheet), where these parameters are given by:

$$F_{50} = F_{min} + \frac{4r_n |\Gamma_s - \Gamma_{OPT}|^2}{(1 - |\Gamma_s|^2) |1 + \Gamma_{OPT}|^2}$$

$$r_n = (F_{50} - F_{min}) \frac{|1 + \Gamma_{OPT}|^2}{4|\Gamma_{OPT}|^2}$$

$$\Gamma_{OPT} = \frac{Z_{OPT} - Z_O}{Z_{OPT} + Z_O}$$

Where

F_{min} is the minimum noise figure that is obtained when $\Gamma_s = \Gamma_{OPT}$.

R_n is the noise resistance that indicates the sensitivity of the noise performance.

Γ_s is the source reflection coefficient presented to the input pin.

Γ_{OPT} is the source reflection coefficient for optimum NF match.

Any change in Γ_s affects the noise figure of our amplifier. To obtain the best noise figure, the following relation: $\Gamma_s = \Gamma_{OPT}$ must be

satisfied. However, this might affect our return loss at the input because it creates more mismatch (at the input) and there is less power transfer to the LNA.

Therefore the best solution should be the one that gives a reasonable input return loss with the best noise figure associated to it.

The noise figure F of an amplifier is determined by the input matching circuit. The output matching does not affect the noise (has a significantly minimal effect on noise figure).

To obtain the best noise match a simple two elements match is used at the input of the device. Using the Γ_{OPT} magnitude and phase at the frequency of interest, the noise match is done. The topology that has a capacitor to ground is ignored because it does not allow the input to be DC grounded as is required by the source bias method. Therefore the series-L-shunt-L topology is used. The final values of the noise matching circuit (input match) was a result of some more empirical tuning in the lab that was a compromise between the various important parameters. Typical Gain, noise and stability circles are shown in Figures 17 – 20. Most simulations were done using Avago-EEsof's Advanced Design System (ADS).

Stability

A stable circuit is a circuit that does not oscillate. Oscillation can take the form of spurious signal and noise generation. This usually results in changes in DC operating point (bias level fluctuates). The oscillations can be triggered by changes in the source (input match), load (output match), bias level and last but not least: improper grounding.

Design for Stability

The main potential for oscillation with the MGA-71543 is improper grounding and/or improper RF bypass capacitors. Any device with gain can be made to oscillate if feedback is added. Proper grounding may be achieved by minimizing inductance paths to the ground plane. Passive components should be chosen for high frequency operation. Bias circuit self resonance due to inadequate bypass capacitors or inadequate grounding may cause high frequency, out of band, instability. Smaller 0402 size bypass capacitors are recommended to minimize parasitic inductance and resonance of the bias circuit.

Statistical Parameters

Several categories of parameters appear within the electrical specification portion of the MGA-71543 datasheet. Parameters may be described with values that are either “minimum or maximum”, “typical” or “standard deviations”.

The values for parameters are based on comprehensive product characterization data, in which automated measurements are made on a statistically significant number of parts taken from nonconsecutive process lots of semiconductor wafers. The data derived from product characterization tends to be normally distributed, e.g. fits the standard bell curve.

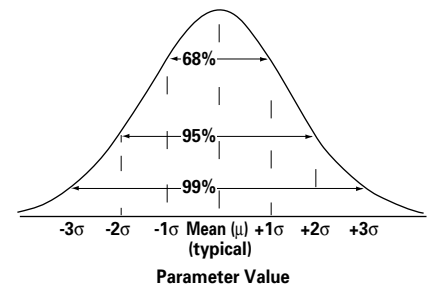

Figure 15. Normal Distribution Curve.

Parameters considered to be the most important to system performance are bounded by *minimum* or *maximum* values. For the MGA-71543, these parameters are: $V_{ref\ test}$, NF_{test} , G_{atest} , $IIP_{3\ test}$, and IL_{test} . Each of the guaranteed parameters is 100% tested as part of the normal manufacturing and test process.

Values for most of the parameters in the table of Electrical Specifications that are described by *typical* data are the mathematical mean (μ), of the normal distribution taken from the characterization data. For parameters where measurements or mathematical averaging may not be practical, such as S-parameters or Noise parameters and the performance curves, the data represents a nominal part taken from the center of the characterization distribution. Typical values are intended to be used as a basis for electrical design.

To assist designers in optimizing not only the immediate amplifier circuit using the MGA-71543, but to also evaluate and optimize tradeoffs that affect a complete wireless system, the *standard deviation* (σ) is provided for many of the Electrical Specification parameters (at 25°C). The standard deviation is a measure of the variability about the mean. It will be recalled that a normal distribution is completely described by the mean and standard deviation.

Standard statistics tables or calculations provide the probability of a parameter falling between any two values, usually symmetrically located about the mean. Referring to Figure 15 for example, the probability of a parameter being between $\pm 1\sigma$ is 68.3%; between $\pm 2\sigma$ is 95.4%; and between $\pm 3\sigma$ is 99.7%.

Phase Reference Planes

The positions of the reference plane used to specify S-parameters and Noise Parameters for the MGA-71543 are shown in Figure 16. As seen in the illustration, the reference planes are located at the point where the package leads contact the test circuit.

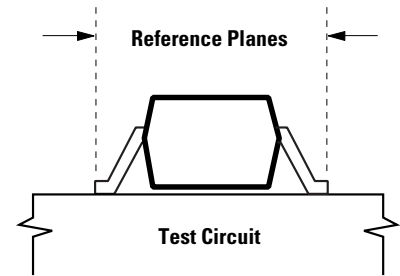

Figure 16. Phase Reference Planes.

Demonstration Board

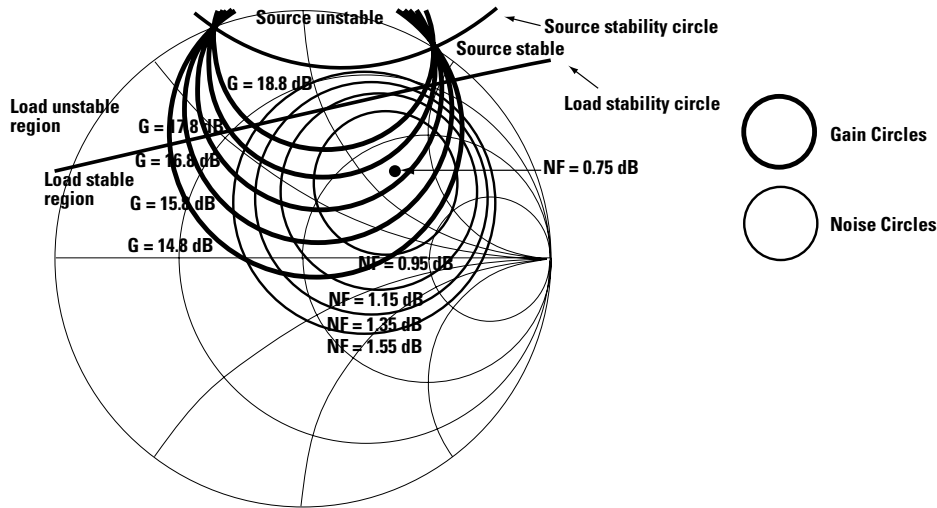

Figure 18. Gain, Noise and Stability Circles.

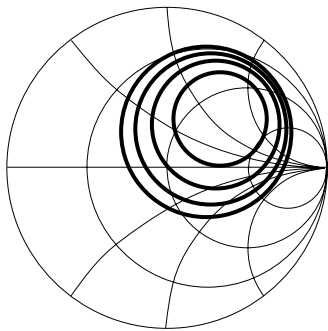

Figure 19. Noise Circles F = 1900 MHz, Step Size: 0.2 dB.

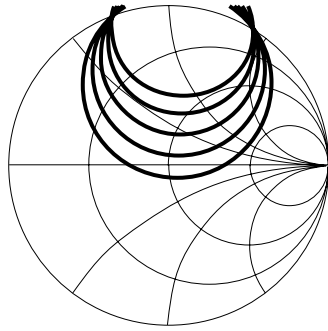

Figure 20. Gain Circle F = 1900 MHz, Step Size: 1.0 dB.

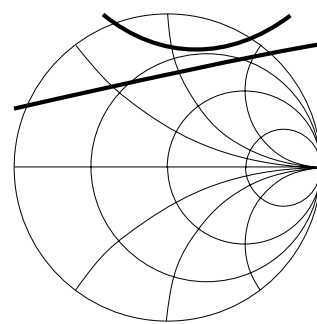

Figure 21. Load and Source Stability Circles.

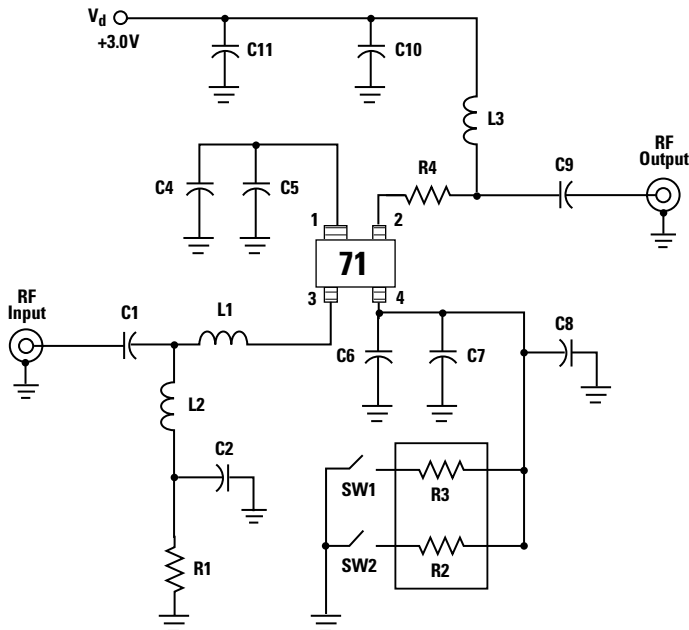

Figure 22. Schematic Diagram of Evaluation Board Amplifier.

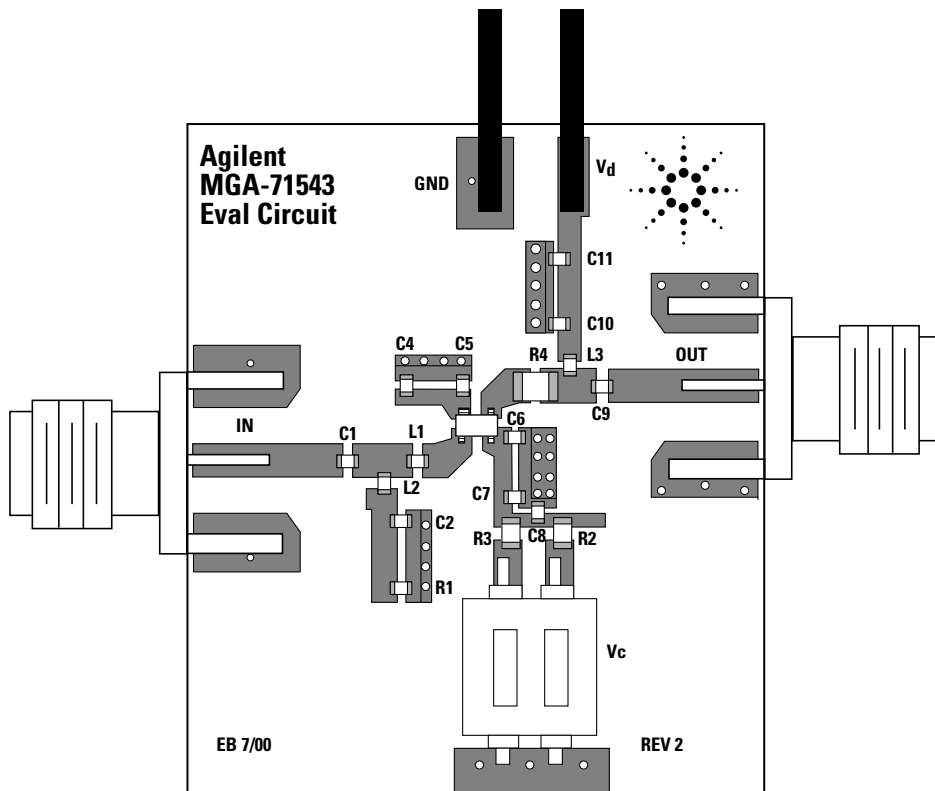

Figure 23. Amplifier Evaluation Circuit with Component Designators. Actual board size is 1.1 x 1.3 inches, 0.031 inches thick.

Board Designation	Description PCS-1900 800 MHz		Part Number	Package
71	DUT ^[1]	DUT ^[1]	MGA-71543	SOT-343 (4 lead SC-70 package)
C1	100 pF	8.2 pF		Size 0402
C2, C5, C6, C7, C10	100 pF	100 pF		Size 0402
C9	47 pF	2.7 pF		Size 0402
C4, C8, C11	0.01 μ F	0.01 μ F		Size 0603 or 0402
L1	1.5 nH	18 nH	TOKO LL1005	Size 0402
L2	2.7 nH	33 nH	TOKO LL1005	Size 0402
L3	3.9 nH	33 nH	TOKO LL1005	Size 0402
R1	51 Ω	51 Ω		Size 0402
R2	115 Ω	115 Ω		Size 0805 (for 6mA Bias)
R4 / L4	0 Ω (1900)	18 nH	— / LL1608-FH or 1005-FH	Size 0805 (Jumper) / Size 0603 (inductor)
R3	60 Ω	60 Ω		Size 0805 (for 10mA Bias)

Note 1: Device under Test

Table 1. Component Values for 1900 MHz and 800 MHz.

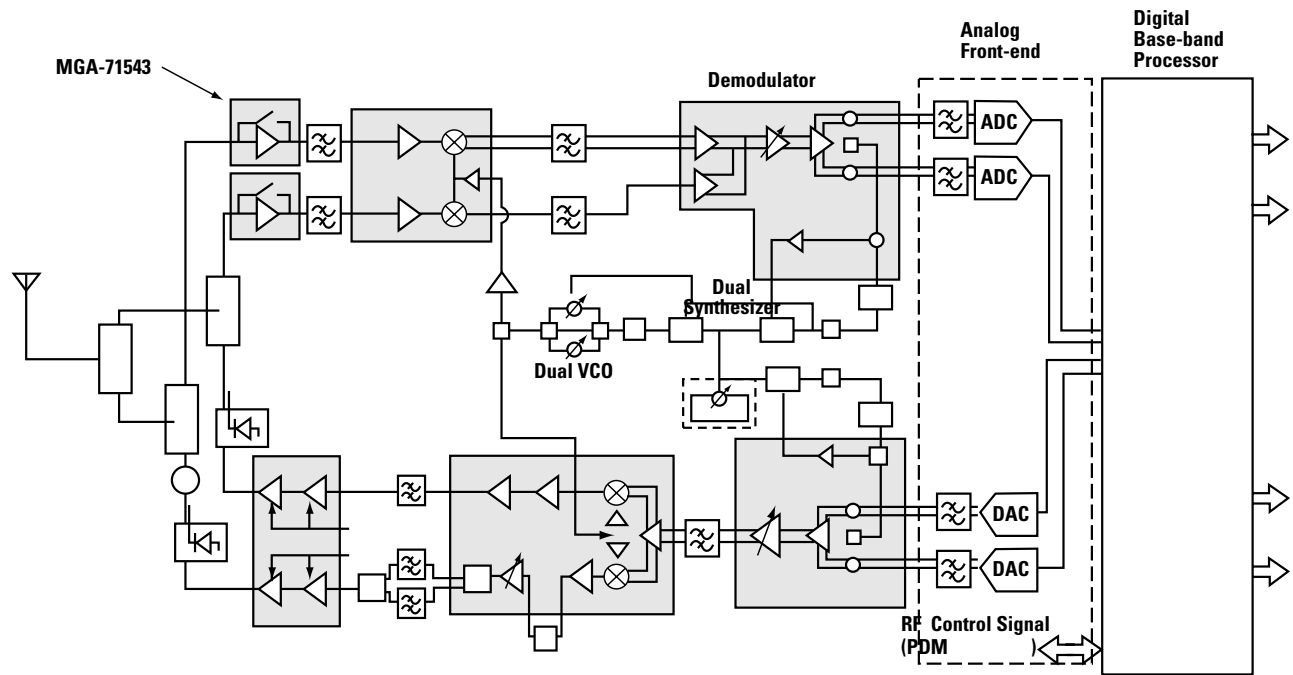

Figure 24. System Level Overview of MGA-71543 for Handset Designers.

These are the actual necessary components.
The other connectors and board space are only for production.

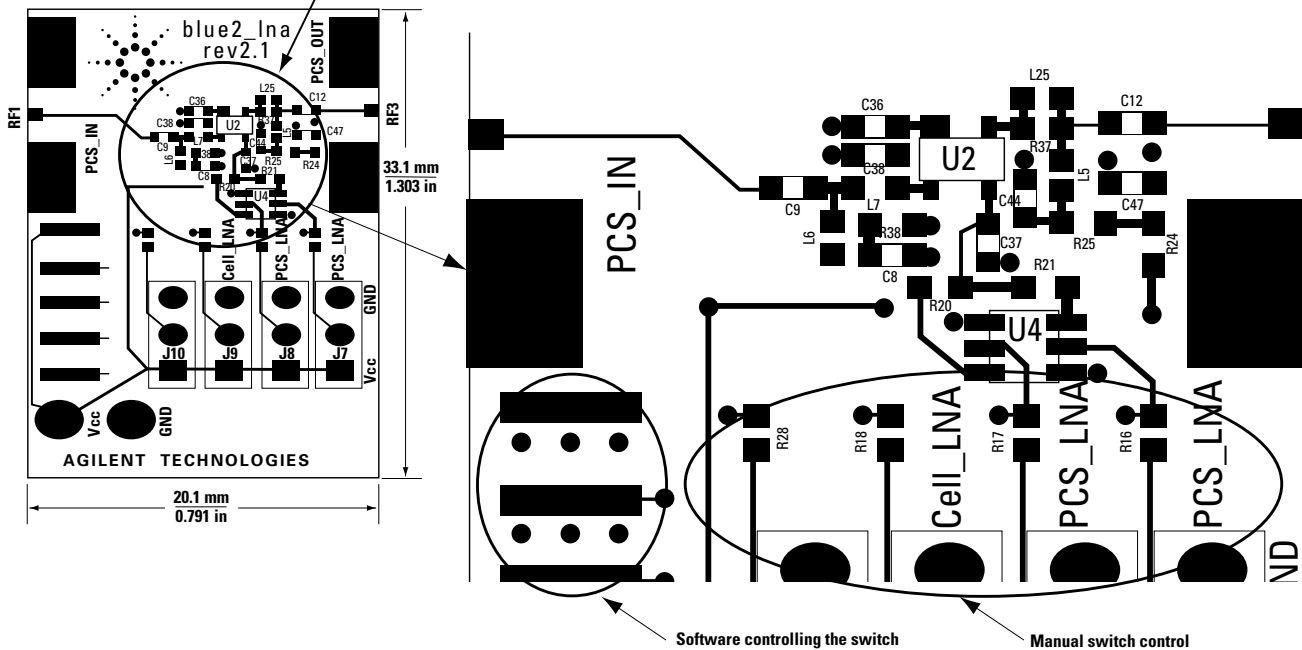

Figure 25. Small Size Amplifier Board with Components for Handset Focused Designers.

4 layer Board Designation	Description PCS-1900	Part Number	Package
U2 or 71	DUT ⁽¹⁾	MGA-71543	SOT-343 (SC-70)
U4 or O3	Switch b/n Gnd resistors	FDG6303N	Dual N-channel, Digital FET
C12	2.2 pF		Size 0402
C8, C47	0.033 μ F		Size 0402
C9, C44	100 pF		Size 0402
C38	Not used		
C36, C37	27 pF		Size 0402
L5	3.9 nH	TOKO LL1005	Size 0402
L6	4.7 nH	TOKO LL1005	Size 0402
L7	1.5 nH	TOKO LL1005	Size 0402
L25	Not used		For tuning/Not used here
R38	51 Ω		Size 0402
R20	36 Ω		Size 0402 (for 16 mA Bias)
R21	56 Ω		Size 0402 (for 11 mA Bias)
R24, R25	6 Ω		Size 0402
R16, R17	0 Ω		Size 0402 (Jumper)
R37	0 Ω		Size 0402 (Jumper)
R18, R28	Not used		Used with other FET switches

Note 1: Device under Test

Table 2. Component Values for 1900 MHz Amplifier on Smaller Board.

References

1. Application note RLM020199, "Designing with the MGA-72543 RFIC Amplifier/Bypass Switch".
2. G.D.Vendelin, A.M.Pavio and U.L.Rhode, "Microwave Circuit Design Using Linear and Nonlinear Techniques".

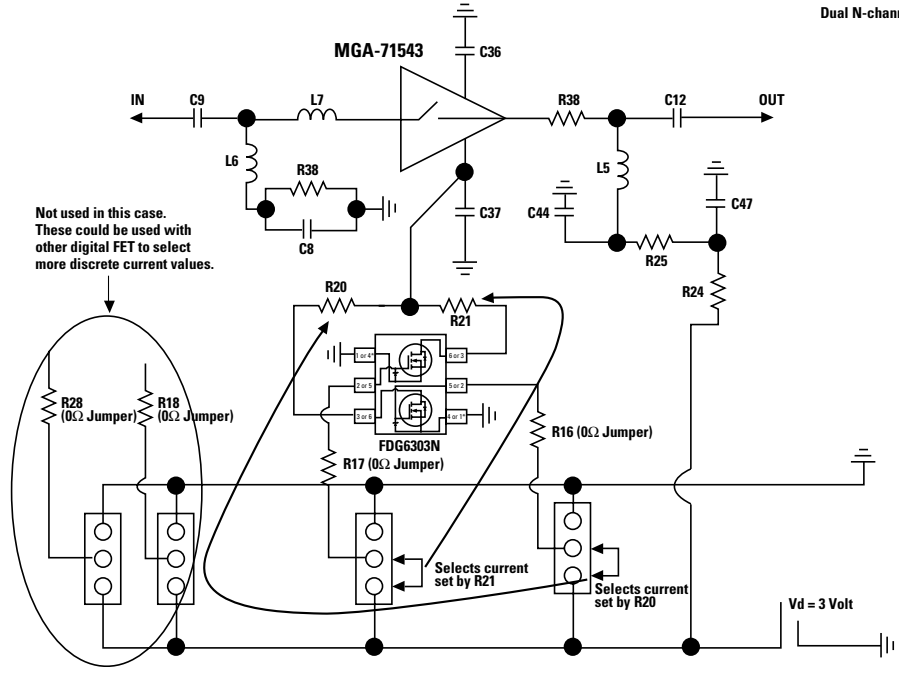
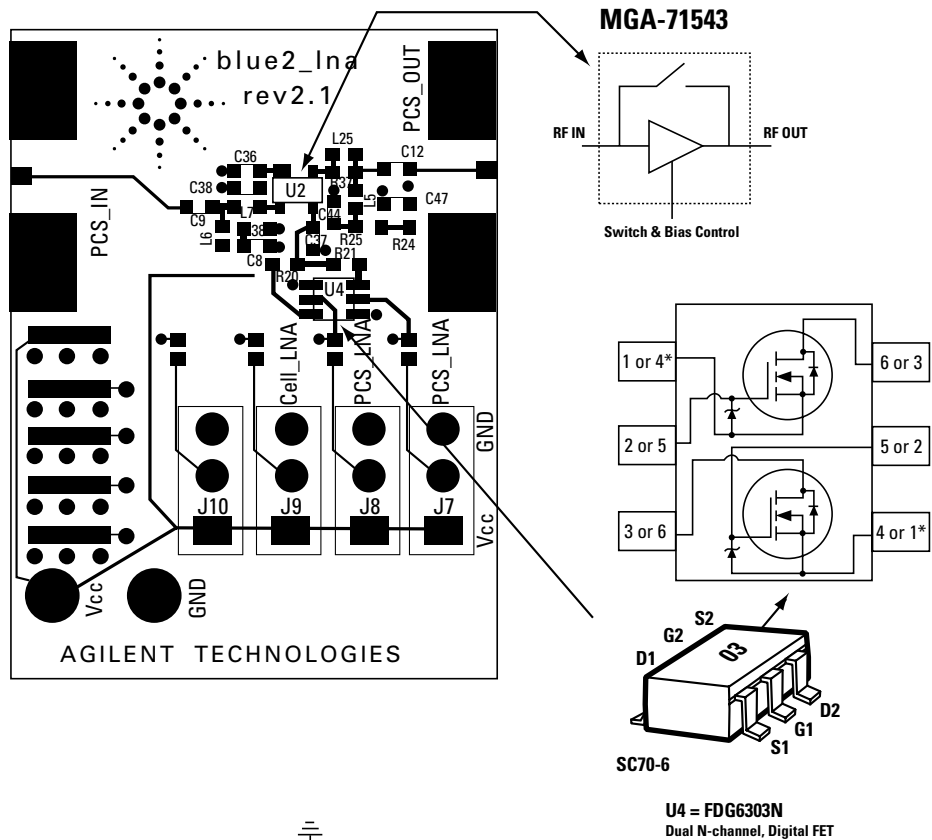

Figure 26. LNA Bypass Circuit Control on Small Test Board.

For product information and a complete list of distributors, please go to our web site: www.avagotech.com

Avago, Avago Technologies, and the A logo are trademarks of Avago Technologies in the United States and other countries. Data subject to change. Copyright © 2005-2015 Avago Technologies. All rights reserved. Obsoletes 5989-4193EN AV02-3597EN - September 28, 2015

