

Features

- Epitaxial Planar Die Construction
- Complementary PNP Type Available (MMST3906)
- Ultra-Small Surface Mount Package
- Also Available in Lead Free Version

Mechanical Data

- Case: SOT-323, Molded Plastic
- Case Material - UL Flammability Rating 94V-0
- Moisture sensitivity: Level 1 per J-STD-020A
- Terminals: Solderable per MIL-STD-202, Method 208
- Also Available in Lead Free Plating (Matte Tin Finish). Please see Ordering Information, Note 4, on Page 2
- Terminal Connections: See Diagram
- Marking (See Page 2): K2N
- Ordering & Date Code Information: See Page 2
- Weight: 0.006 grams (approx.)

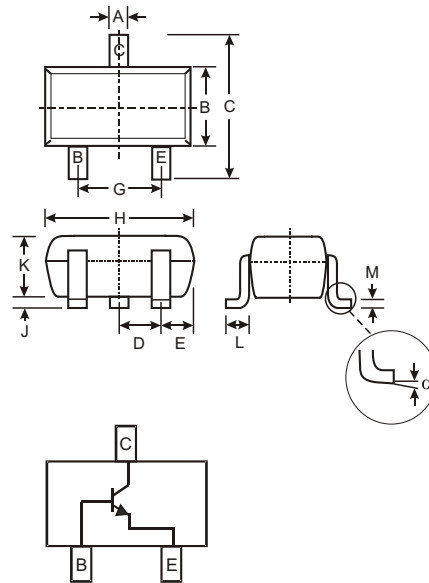

SOT-323		
Dim	Min	Max
A	0.25	0.40
B	1.15	1.35
C	2.00	2.20
D	0.65 Nominal	
E	0.30	0.40
G	1.20	1.40
H	1.80	2.20
J	0.0	0.10
K	0.90	1.00
L	0.25	0.40
M	0.10	0.18
α	0°	8°
All Dimensions in mm		

Maximum Ratings @ $T_A = 25^\circ\text{C}$ unless otherwise specified

Characteristic	Symbol	MMST3904	Unit
Collector-Base Voltage	V_{CBO}	60	V
Collector-Emitter Voltage	V_{CEO}	40	V
Emitter-Base Voltage	V_{EBO}	6.0	V
Collector Current - Continuous (Note 1)	I_C	200	mA
Power Dissipation (Note 1)	P_d	200	mW
Thermal Resistance, Junction to Ambient (Note 1)	$R_{\theta JA}$	625	$^\circ\text{C}/\text{W}$
Operating and Storage and Temperature Range	T_J, T_{STG}	-55 to +150	$^\circ\text{C}$

Note: 1. Device mounted on FR-4 PCB, 1 inch x 0.85 inch x 0.062 inch; pad layout as shown on Diodes Inc. suggested pad layout document AP02001, which can be found on our website at <http://www.diodes.com/datasheets/ap02001.pdf>.

Electrical Characteristics @ T_A = 25°C unless otherwise specified

Characteristic	Symbol	Min	Max	Unit	Test Condition
OFF CHARACTERISTICS (Note 2)					
Collector-Base Breakdown Voltage	V _{(BR)CBO}	60	—	V	I _C = 10μA, I _E = 0
Collector-Emitter Breakdown Voltage	V _{(BR)CEO}	40	—	V	I _C = 1.0mA, I _B = 0
Emitter-Base Breakdown Voltage	V _{(BR)EBO}	5.0	—	V	I _E = 10μA, I _C = 0
Collector Cutoff Current	I _{CEX}	—	50	nA	V _{CE} = 30V, V _{EB(OFF)} = 3.0V
Base Cutoff Current	I _{BL}	—	50	nA	V _{CE} = 30V, V _{EB(OFF)} = 3.0V
ON CHARACTERISTICS (Note 2)					
DC Current Gain	h _{FE}	40 70 100 60 30	— — 300 — —	—	I _C = 100μA, V _{CE} = 1.0V I _C = 1.0mA, V _{CE} = 1.0V I _C = 10mA, V _{CE} = 1.0V I _C = 50mA, V _{CE} = 1.0V I _C = 100mA, V _{CE} = 1.0V
Collector-Emitter Saturation Voltage	V _{CE(SAT)}	—	0.25 0.30	V	I _C = 10mA, I _B = 1.0mA I _C = 50mA, I _B = 5.0mA
Base-Emitter Saturation Voltage	V _{BE(SAT)}	0.65 —	0.85 0.95	V	I _C = 10mA, I _B = 1.0mA I _C = 50mA, I _B = 5.0mA
SMALL SIGNAL CHARACTERISTICS					
Output Capacitance	C _{obo}	—	4.0	pF	V _{CB} = 5.0V, f = 1.0MHz, I _E = 0
Input Capacitance	C _{ibo}	—	8.0	pF	V _{EB} = 0.5V, f = 1.0MHz, I _C = 0
Input Impedance	h _{ie}	1.0	10	kΩ	V _{CE} = 10V, I _C = 1.0mA, f = 1.0kHz
Voltage Feedback Ratio	h _{re}	0.5	8.0	x 10 ⁻⁴	
Small Signal Current Gain	h _{fe}	100	400	—	
Output Admittance	h _{oe}	1.0	40	μS	
Current Gain-Bandwidth Product	f _T	300	—	MHz	V _{CE} = 20V, I _C = 10mA, f = 100MHz
Noise Figure	NF	—	5.0	dB	V _{CE} = 5.0V, I _C = 100μA, R _S = 1.0kΩ, f = 1.0kHz
SWITCHING CHARACTERISTICS					
Delay Time	t _d	—	35	ns	V _{CC} = 3.0V, I _C = 10mA, V _{BE(off)} = -0.5V, I _{B1} = 1.0mA
Rise Time	t _r	—	35	ns	

Ordering Information (Note 3)

Device	Packaging	Shipping
MMST3904-7	SOT-323	3000/Tape & Reel

- Notes: 2. Short duration test pulse used to minimize self-heating effect.
 3. For Packaging Details, go to our website at <http://www.diodes.com/datasheets/ap02007.pdf>.
 4. For Lead Free version (with Lead Free terminal finish) part number, please add "-F" suffix to part number above.
 Example: MMST3904-7-F.

Marking Information

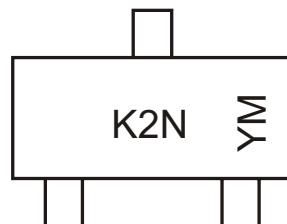

K2N = Product Type Marking Code
 YM = Date Code Marking
 Y = Year ex: N = 2002
 M = Month ex: 9 = September

Date Code Key

Year	1998	1999	2000	2001	2002	2003	2004	2005	2006	2007	2008	2009
Code	J	K	L	M	N	P	R	S	T	U	V	W

Month	Jan	Feb	March	Apr	May	Jun	Jul	Aug	Sep	Oct	Nov	Dec
Code	1	2	3	4	5	6	7	8	9	O	N	D

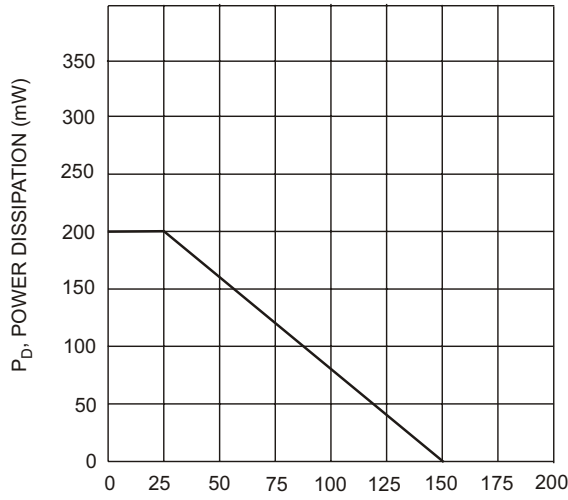

T_A, AMBIENT TEMPERATURE (°C)
Fig. 1, Max Power Dissipation vs Ambient Temperature

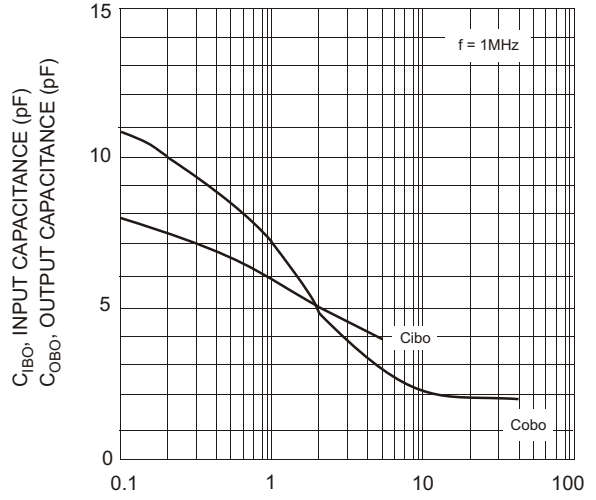

V_{CB}, COLLECTOR-BASE VOLTAGE (V)
Fig. 2, Input and Output Capacitance vs. Collector-Base Voltage

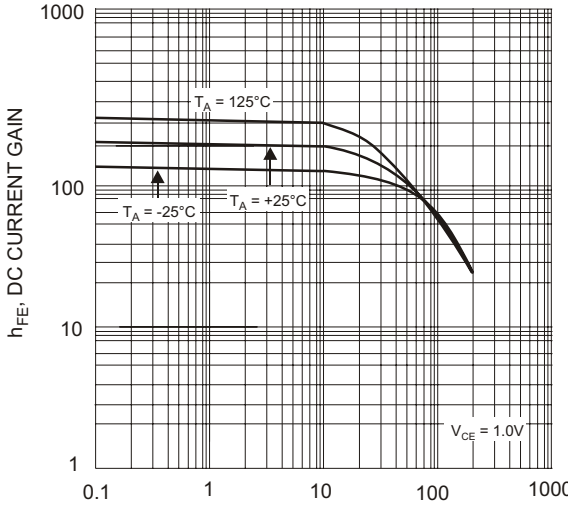

I_C, COLLECTOR CURRENT (mA)
Fig. 3, Typical DC Current Gain vs Collector Current

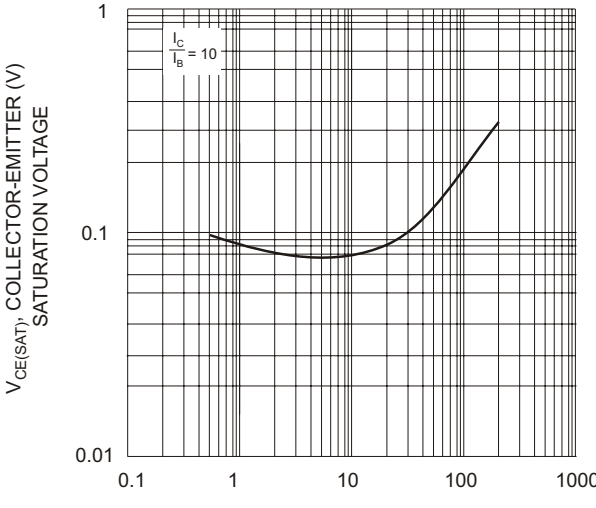

I_C, COLLECTOR CURRENT (mA)
Fig. 4, Typical Collector-Emitter Saturation Voltage vs. Collector Current

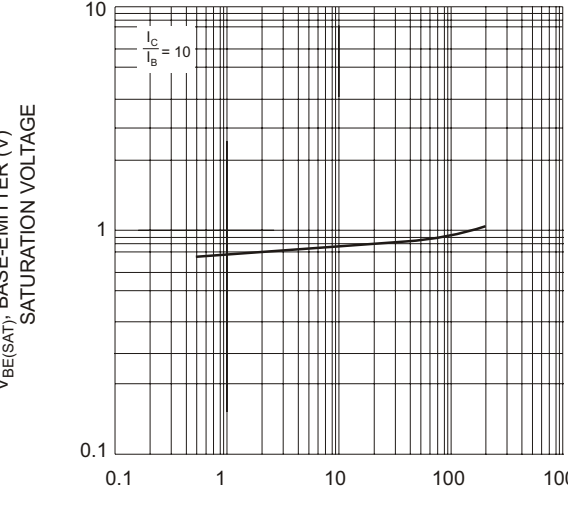

I_C, COLLECTOR CURRENT (mA)
Fig. 5, Typical Base-Emitter Saturation Voltage vs. Collector Current